

INSTRUCTIONS FOR USE

# Alpha Active 3



## **WARNING**

**To avoid injury, always read this Instructions for Use and accompanied documents before using the product.**



**Mandatory to read the Instructions for Use**

Design Policy and Copyright

® and ™ are trademarks belonging to the Arjo group of companies.

© Arjo 2019.

As our policy is one of continuous improvement, we reserve the right to modify designs without prior notice. The content of this publication may not be copied either whole or in part without the consent of Arjo.

# Contents

<b>General Safety</b> .....	<b>iii</b>
<b>Introduction</b> .....	<b>1</b>
About this Manual .....	1
Intended Use .....	1
About Alpha Active 3 .....	1
Alpha Active 3 Pump .....	1
Alpha Active 3 Mattress Overlay .....	2
<b>Clinical Applications</b> .....	<b>4</b>
Indications .....	4
Contraindications .....	4
Cautions .....	4
<b>Installation</b> .....	<b>5</b>
Preparing the system for use .....	5
Installing the Mattress .....	5
<b>Controls, Alarms and Indicators</b> .....	<b>7</b>
Controls .....	7
Alarms and Indicators .....	8
<b>Mattress - Pump Operation</b> .....	<b>9</b>
Quick Start .....	9
Support Setting Procedure .....	9
Changes in Patient Position .....	10
To Deflate and Store the Alpha Active 3 Mattress .....	11
CPR Control .....	12
To activate CPR .....	12
To reset CPR .....	12
<b>Decontamination</b> .....	<b>13</b>
<b>Routine Maintenance</b> .....	<b>15</b>
Alpha Active 3 System .....	15
Alpha Active 3 Pump .....	15
Alpha Active 3 Mattress Overlay .....	15
Serial Labels .....	15
<b>Troubleshooting and Alarm Conditions</b> .....	<b>16</b>
<b>Technical Description</b> .....	<b>17</b>
Pump .....	17
Symbols .....	18
Mattress .....	19
Mattress Size Information .....	19
Cleaning Symbols .....	20
Cover Specification .....	20
Electromagnetic Compatibility (EMC) .....	21

Intentionally left blank

# General Safety

Before you connect the system pump to a mains socket, read carefully all the installation instructions contained within this manual.

The system has been designed to comply with regulatory safety standards including:

- EN60601-1:2006/A1:2013 and IEC 60601-1:2005/A1:2012
- EN60601-1-11:2010; IEC 60601-1-11:2010 and IEC 60601-1-8:2012
- ANSI/AAMI ES60601-1(2005)+AMD(2012) and CAN/CSA-C22.2 No.60601-1(2008)+(2014)

## Safety Warnings

- **It is the responsibility of the care giver to ensure that the user can use this product safely.**
- **Whilst the patient is unattended, safety sides should be used based on clinical assessment and in line with local policy.**
- **Alignment of the bed frame, safety sides and the mattress should leave no gap wide enough to entrap a patient's head or body, or to allow egress to occur in a hazardous manner where entanglement with the mains power cable and tubeset or air hoses may result. Care should be exercised to prevent occurrence of gaps by compression or movement of the mattress. Death or serious injury may occur.**
- **Make sure that the mains power cable and tubeset or air hoses are positioned to avoid causing a trip or other hazard, and are clear of moving bed mechanisms or other possible entrapment areas. Where cable management flaps are provided along the sides of the mattress, these should be used to cover the mains power cable.**
- **Electrical equipment may be hazardous if misused. There are no user-serviceable parts inside the pump. The pump's case must only be removed by authorised technical personnel. No modification of this equipment is allowed.**
- **The mains power socket/plug must be accessible at all times. To disconnect the pump completely from the electricity supply, remove the plug from the mains power socket.**
- **The CPR control and/or the CPR indicator tag must be visible and accessible at all times.**
- **Disconnect the pump from the mains power socket before cleaning and inspecting.**
- **Keep the pump away from sources of liquids and do not immerse in water.**
- **Do not use the pump in the presence of uncontained flammable liquids or gasses.**
- **The cover of this product is vapour permeable but not air permeable and may present a suffocation risk.**
- **Only the pump and mattress combination as indicated by Arjo should be used. The correct function of the product cannot be guaranteed if incorrect pump and mattress combinations are used.**
- **If a serious incident occurs in relation to this medical device, affecting the user, or the patient then the user or patient should report the serious incident to the medical device manufacturer or the distributor. In the European Union, the user should also report the serious incident to the Competent Authority in the member state where they are located.**

## Precautions

For your own safety and the safety of the equipment, always take the following precautions:

- Placing extra layers between the patient and the mattress potentially reduces the benefits provided by the mattress and should be avoided or kept to a minimum. As part of sensible pressure area care, it is advisable to avoid wearing clothing which may cause areas of localised high pressure due to creases, seams, etc. Placing objects in pockets should be avoided for the same reason.
- Do not expose the system, especially the mattress, to naked flames, such as cigarettes, etc.
- In the event of a fire, a leak in the seat or mattress could propagate the fire.
- Do not store the system in direct sunlight.
- Do not use phenol-based solutions to clean the system.
- Make sure the system is clean and dry prior to use or storage.
- Never use sharp objects or electrically heated under blankets on or under the system.
- Store the pump and mattress in the protective bags supplied.
- Pets and children must be supervised in the vicinity of the system.
- When the pump is in use the operator should remain in area in case the system alarms.

## Electromagnetic Compatibility (EMC)

This product complies with the requirements of applicable EMC Standards. Medical electrical equipment needs special precautions regarding EMC and needs to be installed in accordance with the following instructions:

- The use of accessories not specified by the manufacturer may result in increased emissions by, or decreased immunity of, the equipment, affecting its performance.
- Portable and mobile radio frequency (RF) communications equipment (e.g. mobile/cell phones) can affect medical electrical equipment.
- If this equipment needs to be used adjacent to other electrical equipment, normal operation must be checked before use.
- For detailed EMC information contact Arjo service personnel.

## Environmental Protection

Incorrect disposal of this equipment and its component parts, particularly batteries or other electrical components, may produce substances that are hazardous to the environment. To minimise these hazards, contact Arjo for information on correct disposal.

## Expected Service Life

The *Alpha Active*<sup>®</sup> 3 pump has an expected service life of seven years. To maintain the condition of the pump, have the pump serviced regularly according to the schedule recommended by Arjo. Do NOT use unapproved accessories or attempt to modify, disassemble or otherwise misuse the *Alpha Active* 3 system. Failure to observe this caution could result in injury, or in extreme cases, death.

## End of Life Disposal

- Fabric material used on the mattresses or any other textiles, polymers or plastic materials etc. should be sorted as combustible waste.
- Mattresses at the end of life should be disposed of as waste according to the national or local requirements which may be landfill or combustion.
- Pump units have electrical and electronic components should be disassembled and recycled per Waste of Electrical and Electronic Equipment (WEEE) or in accordance with local or national regulation.

# 1. Introduction

## About this Manual

This manual is your introduction to the *Alpha Active 3*.

You must read and fully understand this manual before using the system.

Use this manual to initially set up the system, and keep it as a reference for day-to-day routines and as a guide to maintenance.

If you have any difficulties in setting-up or using the *Alpha Active 3* system, contact your local Arjo sales office, listed at the end of this manual.

## Intended Use

The intended use of this product is to prevent and/or manage pressure ulcers for patients up to 135 kg (297 lb).

The *Alpha Active 3* system should be used as part of a prescribed plan of care (refer to Page 4 "Indications").

## About Alpha Active 3

The *Alpha Active 3* systems comprise of a mattress overlay and pump. The support system can be used on hospital beds and domestic beds in acute care, long-term care and homecare environments, including private homes.

## Alpha Active 3 Pump

The *Alpha Active 3* pump comprises of a moulded case with non slip feet on the base and integral hanging brackets.



The controls are situated on the front of the pump. An alarm system differentiates between normal operation and genuine system faults. If an alarm situation is detected an indicator will illuminate on the front of the pump and an audible warning will sound.

## **Alpha Active 3 Mattress Overlay**

The *Alpha Active 3* mattress overlay comprises the following components:

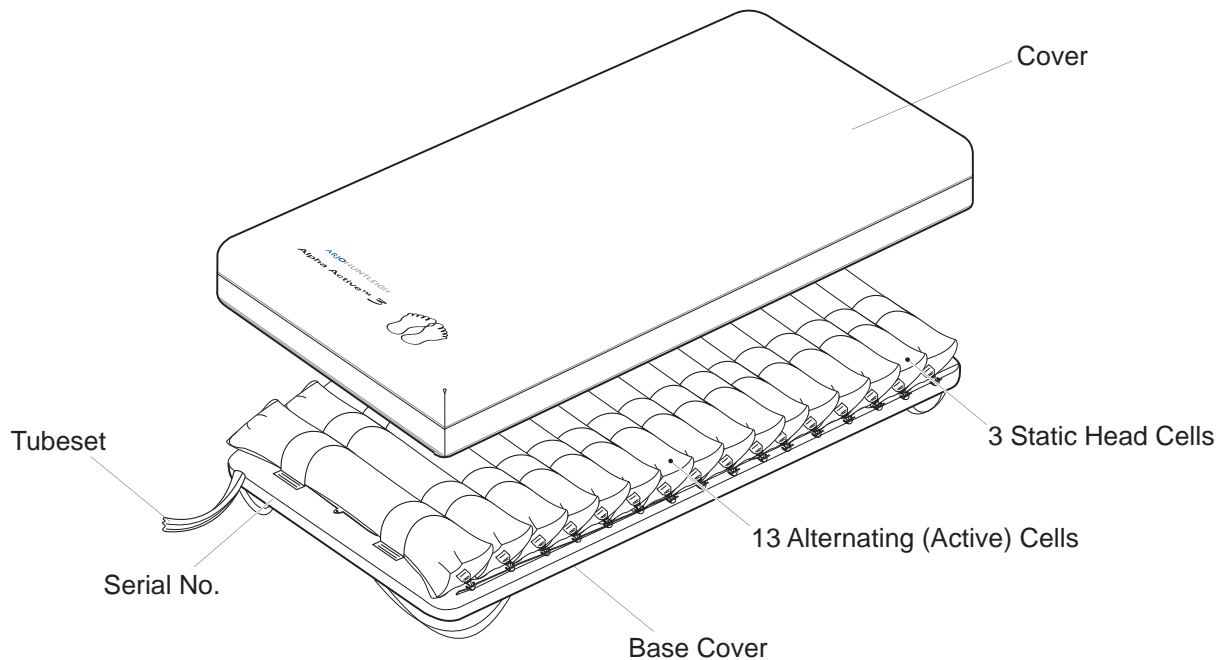

### **Detachable Cover**

The standard cover comprises of a 2-way stretch polyurethane (PU) coated knitted fabric zipped to a durable nylon base. The zips are protected by flaps to prevent ingress of contaminants and allow easy removal of the cover for cleaning.

### **Cells**

The mattress comprises of 16 polyurethane (PU) cells, 13 providing support to the user in either Alternating (Active) or Static (Reactive) mode and 3 Static head cells.

#### **NOTE**

*The head cells are not involved for alternating, so these cells don't provide pressure ulcer management function. Check patient head area on a regular basis and be vigilant to skin issue are necessary to patient care.*

### **CPR function**

A CPR (Cardio-Pulmonary Resuscitation) control is positioned at the head end of the mattress to allow rapid deflation of the mattress overlay.



**Tube-set** The tube-set has a 2-way pneumatic connection which incorporates a flexible, compact anti-kink tube that is resistant to crushing and any subsequent obstruction of air flow.

When disconnecting the tube-set, place the attached cover over the end to place the mattress in transport mode.

**Overlay Base Cover** The base cover for the mattress overlay is PU coated nylon on the underside. Four corner retention straps are incorporated, which slide under the corners of the base mattress.

A full technical description of the *Alpha Active 3* system can be found in the Service Manual, part number SER0017, available from your Arjo sales office.

---

## 2. Clinical Applications

---

**Indications** The *Alpha Active 3* system is indicated for the prevention and/or management of all categories<sup>1</sup> of pressure ulcer, when combined with an individualised, comprehensive pressure ulcer protocol: for example, repositioning, nutritional support, skin care. Selection should be based upon a holistic assessment of the patient's individual care needs.

The systems represent one aspect of a pressure ulcer management protocol; all other aspects of care should be considered by the prescribing clinician.

If existing wounds do not improve or the patient's condition changes the overall therapy regimen should be reviewed by the prescribing clinician.

The above are guidelines only and should not replace clinical judgement.

The *Alpha Active 3* mattress is designed for patients weighing up to 135 kg (297 lb).

**Contraindications** Do not use *Alpha Active 3* system for patients with unstable spinal fractures.

**Cautions** If patients have other unstable fractures, or conditions which may be complicated by a soft or moving surface, advice should be sought from an appropriate clinician before use.

While the *Alpha Active 3* system has been designed to manage patients up to the weight limits indicated above, those approaching this upper limit are likely to have additional care and mobility needs and may be better suited to a specialist bariatric system.

**NOTE**

*The above are guidelines only and should not replace clinical judgement or experience.*

1. NPUAP/EPUAP International Pressure Ulcer Guideline, 2014.

---

## 3. Installation

---

### Preparing the system for use

Remove the system from the packaging. You should have the following items:

- *Alpha Active 3* pump including mains power cord and hanging brackets.
- *Alpha Active 3* mattress overlay with integral tube-set.
- Cover.

### Installing the Mattress

<p style="text-align: center;"><b>Caution</b></p>
---

<p style="text-align: center;"><b>Do not use the mattress overlay directly on the bed frame.</b></p>
--

#### ***Mattress Overlay***

The *Alpha Active 3* mattress overlay system should be installed as follows:

1. Place the overlay on top of the base mattress, with the tube-set located near the foot end of the bed and the CPR at the head end. The cells of the mattress must be uppermost.
2. Secure the overlay to the base mattress by placing the four long straps under the corners of the base mattress.

#### ***To Complete the Mattress Installation***

Complete the installation of the mattress overlay as follows:

1. If not already fitted, place the protective cover over the mattress. Ensure that the logo is uppermost and at the foot end of the mattress.
2. Zip the cover onto the mattress starting from the head end and taking care not to trap any material in the zip.
3. Ensure that the CPR unit is secured in its closed position.

<p><b>NOTE</b></p>
--------------------

<p><i>The CPR must be accessible at all times.</i></p>
--

## WARNING

**Make sure that the mains power cable is positioned to avoid causing a hazard and is clear of moving bed mechanisms or other possible entrapment areas.**

### ***Installing the Pump***

The pump should be installed as follows:

1. Position the pump, feet down, on any convenient horizontal surface or alternatively suspend from the bed foot rail by means of the integral hanging brackets.
2. Ensure that the mattress tube-set is not "kinked" or twisted and connect it to the pump until it clicks into place. Ensure that the tube-set is securely connected to the pump.
3. Insert the mains power plug into a suitable mains power socket.
4. Put the mains cable under the mattress using the three mattress cable ties. The magic cable tie can be used to manage the surplus cable by the bed foot rail.

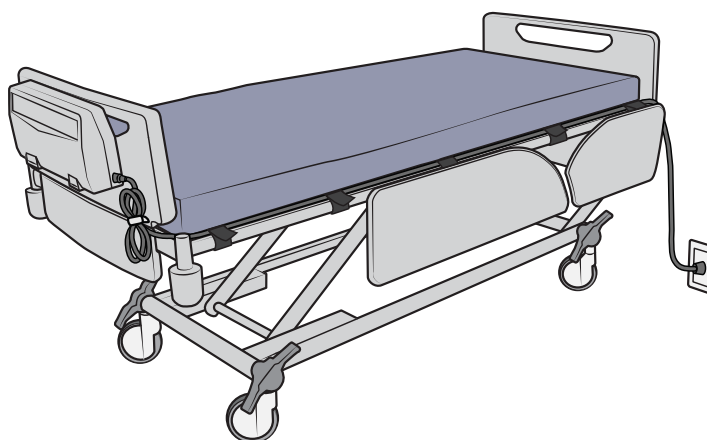

### ***System Operation***

The system is now ready for use. Refer to Page 9 "Mattress - Pump Operation" for day-to-day operating instructions.

# 4. Controls, Alarms and Indicators

## Controls

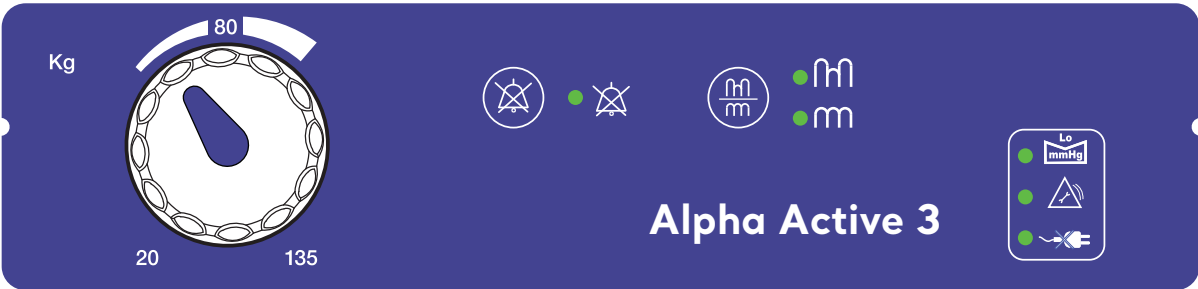

**On/Off Button** Pressing the **On/Off** button will activate the pump. The pump will perform a self test during which all LEDs will illuminate, and audible beeps will sound.

**Alarm Mute** During an alarm condition the sound of the alarm can be muted by pressing this button. The muted state can also be terminated manually by pressing this button again.



**Mode Selector** The mode selector allows the mode of operation to be selected. Two modes of operation are available, Alternating or Static (non-alternating). The indicator next to the respective icon indicates the currently selected mode.



**Pressure Control** This is a rotary action control used to manually set the pressure inside the mattress overlay and therefore the amount of support the patient receives.

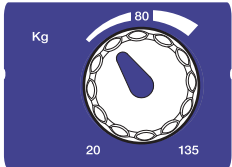

## Alarms and Indicators

### **Low Pressure Indicator**



The **Low Pressure** indicator is illuminated whenever the pump detects low pressure within the mattress overlay. An audible alarm will sound unless cancelled by the **mute** button.

The indicator will extinguish once normal pressure is reached.

#### NOTE

*The Low Pressure alarm is inactive for the first 30 minutes of the pump being switched on.*

#### NOTE

*The Low Pressure alarm is inactive for the first 30 minutes of the pump being switched on.*

### **Service Indicator/ Pump Fault**



The **Service/pump fault** indicator will illuminate, an audible alarm will sound and remain on if the pump has detected an internal fault. A Service Engineer should be called.

### **Power Fail Indicator**



The **Power Fail** indicator will illuminate when a mains power failure has been detected. An audible alarm will sound until power is resumed or the pump is switched off using the on/off button.

#### NOTE

*If the operation of the pump changes during use, refer to Page 16 "Troubleshooting and Alarm Conditions" of this IFU before calling a service engineer or contacting your local Arjo sales office.*

---

## 5. Mattress - Pump Operation

---

These instructions cover day-to-day operation of the system. Other operations, such as maintenance and repair, should only be carried out by suitably qualified personnel.

### NOTE

Refer to Page 7 “Controls, Alarms and Indicators” for a comprehensive description of the controls and indicators on the pump.

### WARNING

**Do not place the patient on the mattress until it is fully inflated.**

#### Quick Start

Before using the *Alpha Active 3* mattress overlay make sure it has been installed correctly in accordance with Page 5 “Installation” and ensure that the CPR unit on the mattress is clicked into the closed position.

1. Connect the pump to the mains power supply using the supplied cable and switch on the pump.
2. Press the On/Off button on the side of the pump.
3. Allow approximately 30 minutes for the mattress overlay to inflate fully.
4. Place a bed sheet over the mattress and tuck in loosely. Ensure that the CPR unit is clearly visible at the head end of the bed.

#### Support Setting Procedure

It is important to follow the correct support setting procedure to ensure the patient receives adequate support while achieving maximum pressure redistribution and comfort.

1. Lie or sit the patient on the mattress.
2. Set pressure dial on pump according to patient weight. This should serve as an approximate guide only. An independent clinical determination needs to confirm that the patient is properly supported.
3. Wait 10 minutes while the pump adjusts the pressures.
4. Ensure that the patient is not ‘bottoming out’ by unfastening the cover and sliding a outstretched hand (palm up) underneath the deflated cells below the part of the body where the pressure ulcer exists, or the area at risk for a pressure ulcer.

5. If the caregiver feels less than an inch of support material, the patient has bottomed out and the support pressures should be adjusted accordingly.
6. Bottoming out should be checked at various anatomical sites and while the patient assumes various body positions.

## **Changes in Patient Position**

When a patient is in the lying or supine position, their body weight is dispersed over a large area. When in the sitting position, their body weight is concentrated within a much smaller area and therefore will require more support than in the lying position.

Therefore, when the patient changes position, it may be necessary, in order to maximise the benefit of the support surface, to make adjustments to the setting on the pressure dial.

**From Lying to Sitting** - Increase pressure control.

**From Sitting to Lying** - Decrease pressure control.

This adjustment should be in conjunction with independent clinical determination of appropriate support.

## **Static**

Provides a stable, non-moving support surface for instances where a active therapy surface is contra-indicated e.g. to carry out nursing procedures or for patients unable to tolerate a moving surface. In **Static** mode the support surface remains constant (all cells are equally inflated). Additional nursing assessment must be undertaken in order to direct an individualised repositioning programme.

When operating the system in **Static** mode it may be necessary, where possible, to reduce the pressure setting to increase patient comfort and safety.

## **Power Fail Condition**

If a **Power Fail** condition arises disconnect the tubeset from the pump and place the attached cap over the end of the tubeset to put the mattress into transport mode. Transport mode is non-therapeutic offering support only for up to 12 hours. It is recommended that when in transport mode the patient is frequently monitored. Once power is resumed, re-connect the tubeset to the pump to continue therapy.



**To Disconnect the  
Tubaset**

To disconnect the tube-set at any time, depress the buttons on the top and bottom of the tubeset connector pull the tube-set connector away from the pump.

To deflate the mattress Refer to Page 11 “To Deflate and Store the Alpha Active 3 Mattress”.

**Transport Mode**

To transport a patient using the *Alpha Active 3* mattress overlay, disconnect the tube-set from the pump and place the attached cap over the end of the tubeset to put the mattress into transport mode. This will automatically switch the mattress into transport mode.

The patient will remain supported by the mattress for up to 12 hours.

To resume normal operation, simply reconnect the tube-set and run the pump.

**Caution**

**Transport mode is non-therapeutic offering support only for up to 12 hours. It is recommended that when in transport mode the patient is frequently monitored.**

**To Deflate and Store the *Alpha Active 3* Mattress**

**To deflate the mattress**

1. Disconnect the tube-set from the pump.
2. Activate the CPR control to deflate the mattress.

**To store the mattress**

Following deflation:

1. Bring the tubeset over the mattress to lie parallel to the foot end of the mattress.
2. Roll the mattress from the foot end toward the CPR connector at the head end of the mattress.

## CPR Control

### IMPORTANT IN THE EVENT OF CARDIAC ARREST

In the event of a patient suffering cardiac arrest and CPR needing to be administered:

**To activate CPR** Located at the head end of the mattress overlay (on the same side as the tubeset) is a red strap labelled CPR. In the event of a cardiac arrest pull this from the mattress to deflate.

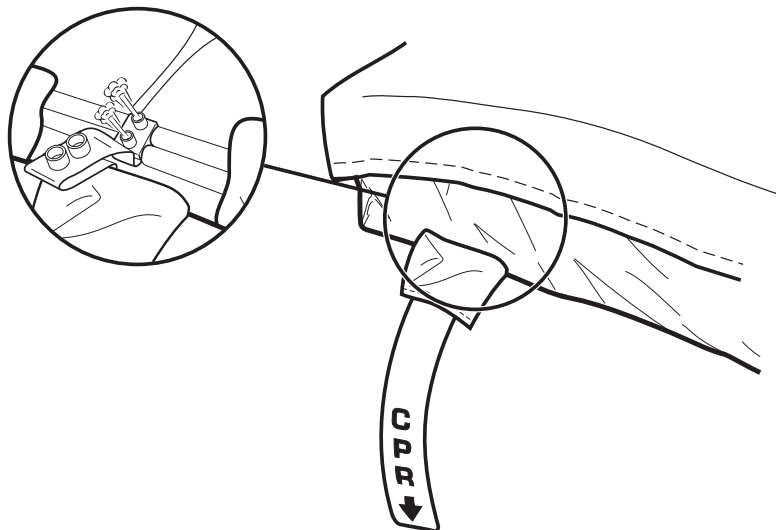
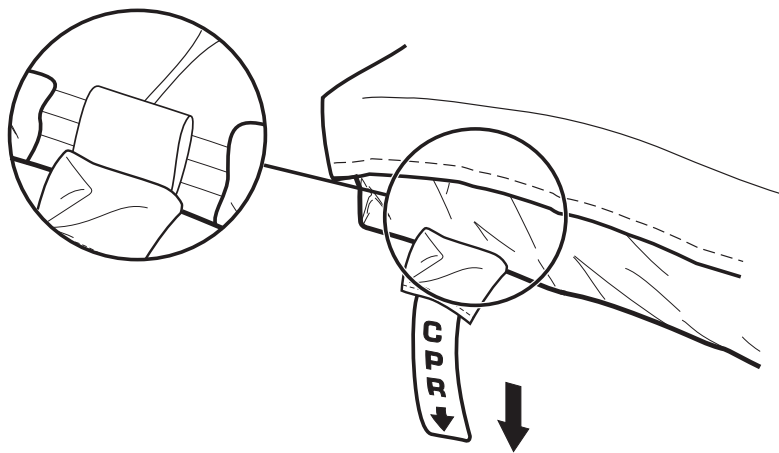

**To reset CPR** To re-inflate the mattress simply replace the stopper securely into the manifold.

---

## 6. Decontamination

---

The following processes are recommended, but should be adapted to comply with the local or national guidelines (Decontamination of Medical Devices) which may apply within the Healthcare Facility or the country of use. If you are uncertain, you should seek advice from your local Infection Control Specialist.

The *Alpha Active 3* system should be routinely decontaminated between patients and at regular intervals while in use; as is good practice for all reusable medical devices.

### WARNING

**Remove the electrical supply to the pump by disconnecting the mains power cord from the mains power supply before cleaning.**

**Protective clothing should always be worn when carrying out decontamination procedures.**

### Caution

**Do not use Phenol-based solutions or abrasive compounds or pads during the decontamination process as these will damage the surface coating. Do not boil or autoclave the cover.**

**Avoid immersing electrical parts in water during the cleaning process. Do not spray cleaning solutions directly onto the pump.**

**To clean** Clean all exposed surfaces and remove any organic debris by wiping with a cloth moistened with a simple (neutral) detergent and water. Dry thoroughly.

Do not allow water or cleaning solutions to collect on the surface of the pump.

**Chemical Disinfection** To protect the integrity of the cover we recommend a chlorine-releasing agent, such as sodium hypochlorite, at a strength of 1,000ppm available chlorine (this may vary from 250ppm to 10,000ppm depending on local policy and contamination status).

Wipe all cleaned surfaces with the solution, rinse and dry thoroughly.

Alcohol based disinfectants (strength 70%) may be used as an alternative.

Ensure the product is dry before storage.

If an alternative disinfectant is selected from the wide variety available we recommend that suitability for use is confirmed with the chemical supplier prior to use.

DO NOT WRING/MANGLE, AUTOCLAVE OR USE PHENOLIC BASED SOLUTIONS.

***Thermal Disinfection*** For information for the mattress top cover, including laundering guidelines, refer to Page 20 “Cover Specification”.

---

## 7. Routine Maintenance

---

### **Alpha Active 3 System**

**Maintenance** The equipment has been designed to be virtually maintenance-free between service periods.

**Servicing** Arjo will make available on request service manuals, component parts lists and other information necessary for Arjo trained personnel to repair the system.

**Service Period** Arjo recommend that the *Alpha Active 3* system should be serviced by an Arjo authorised service agent, after 12 months running time has elapsed.

The Service symbol illuminates to indicate that the pump is ready for a service (refer to Page 8 “Service Indicator/Pump Fault”).

### **Alpha Active 3 Pump**

**General Care, Maintenance and Inspection** Check all electrical connections and power cord for signs of excessive wear.

In the event of the pump being subjected to abnormal treatment, e.g. immersed in water or dropped, the unit must be returned to an authorised service centre.

### **Alpha Active 3 Mattress Overlay**

**General Care** Remove the top cover and inspect for signs of wear or any tears. Check all zips are secure.

Check integrity of all connectors, including cell to manifold connections.

Ensure all cell fasteners are correctly connected to the mattress base sheet and are not loose or damaged.



### **Serial Labels**

**Pump** The serial number for the pump is on the label on the back of the pump case.

**Mattress** The mattress serial label can be found just inside the base cover above the tubeset, refer to the illustration on page Page 2 “Alpha Active 3 Mattress Overlay”.

















## 8. Troubleshooting and Alarm Conditions

The following table provides a troubleshooting and alarm condition guide for the *Alpha Active 3* system in the event of malfunction. These alarms do not cause any delay or interruption in therapy.

Indicator	Possible Cause	Remedy	Priority
<p><b>LOW PRESSURE</b></p> 	<p>The tube-set is not connected properly.</p> <p>CPR not fully closed.</p> <p>There is a leak in the system.</p>	<p>Check the tube-set connector and ensure it is securely fitted to the pump.</p> <p>Close CPR unit.</p> <p>Call service engineer.</p>	<p>Low priority According to IEC60601-1-8</p>
<p><b>POWER FAILURE</b></p> 	<p>Power has been removed from the pump.</p>	<p>Re-apply power or switch the pump off.</p>	<p>Low priority According to IEC60601-1-8</p>
<p><b>SERVICE</b></p> 	<p>Pump has detected an internal fault, such as the gearbox failure.</p>	<p>Switch the pump off and call service engineer.</p>	<p>Low priority According to IEC60601-1-8</p>

## 9. Technical Description

<b>PUMP</b>		
Model:	<i>Alpha Active 3</i>	
Supply Voltage:	230V	
Supply Frequency:	50Hz	
Power Input:	0.1A	
Size:	(L)280mm x (W)205mm x (H)112mm	
Weight:	2.5kg	
Case Material:	ABS Plastic	
Plug Fuse Rating:	5A to BS1362 (UK ONLY)	
Pump Fuse Rating:	2 x T1AL 250V	
Degree of protection against electric shock:	Class II Type BF	
Degree of protection against liquid ingress:	IP21	
Mode of operation:	Continuous	
Cycle Times:	12 mins	
	Inflate - 5.5 mins	
	Crossover - 30 secs	
	Deflate - 5.5 mins	
	Crossover - 30 secs	









SYMBOLS					
	The operator must read this document (Instructions for Use) before use. Note: This symbol is blue on the product label.		Power Disconnects from the mains supply		Power Connects to the mains supply
 E348583 CAN/CSA-C22.2 No 60601-1 (2008)+(2014) and ANSI/AAMI ES 60601-1(2005) +AMD(2012)	With respect to electric shock, fire and mechanical hazards only in accordance with CAN/CSA-C22.2 No. 60601-1 (2008) + (2014) and ANSI/AAMI ES 60601-1 (2005) + AMD (2012) MEDICAL EQUIPMENT		Double Insulated		Type BF
	Refer to this document (Instructions for Use) for a description of the product classification (3rd Edition).		Serial Number		Model number
	Refer to this document (Instructions for Use) for a description of the product classification (2nd Edition).		Do not dispose of in domestic refuse		Dangerous voltage
 2797	CE marking indicating conformity with European Community harmonised legislation Figures indicate Notified Body supervision.		Manufacturer: This symbol is accompanied by the name and the address of the manufacturer.		Date of Manufacture
	Indicates the product is a Medical Device according to EU Medical Device Regulation 2017/745				

PUMP ENVIRONMENTAL INFORMATION			
Condition	Temperature Range	Relative Humidity	Atmospheric Pressure
Operating	+10°C to +40°C (+50°F to +104°F)	30% to 75% (non-condensing)	700hPa to 1060 hPa
Storage (Long Term)	+10°C to +40°C (+50°F to +104°F)	20% to 95% (non-condensing)	700 hPa to 1060 hPa
Storage (Short Term)	-20°C to +50°C (-4°F to +122°F)	20% to 95% (non-condensing)	500 hPa to 1060 hPa
<p>NOTE</p> <p><i>If the pump is stored in conditions outside the “Operating” ranges, allow time for its temperature to stabilise to normal, before use.</i></p>			



<b>MATTRESS</b>		
<b>Description</b>	<b>Cell Material</b>	<b>Base Pad Material</b>
<i>ALPHA ACTIVE 3 MR 90</i>	Nylon PU Coated	Nylon PU Coated
<i>ALPHA ACTIVE 3 MR 85</i>	Nylon PU Coated	Nylon PU Coated
<i>ALPHA ACTIVE 3 MR 85 PU</i>	Polyurethane	Nylon PU Coated
<i>ALPHA ACTIVE 3 MR 80 PU</i>	Polyurethane	Nylon PU Coated
<i>ALPHA ACTIVE 3 MR 90 PU</i>	Polyurethane	Nylon PU Coated

<b>MATTRESS SIZE INFORMATION</b>						
<b>Part No.</b>	<b>Description</b>	<b>Spare Cover</b>	<b>Welded Spare cover</b>	<b>Length mm</b>	<b>Width mm</b>	<b>Height mm</b>
648321	<i>ALPHA ACTIVE 3 MR 90</i>	648430	N/A	1898 (74 3/4")	857 (33 3/4")	125 (5")
648343	<i>ALPHA ACTIVE 3 MR 90 PU</i>					
648323	<i>ALPHA ACTIVE 3 MR 85</i>	648460	N/A		794 (31 1/4")	
648325	<i>ALPHA ACTIVE 3 MR 85 PU</i>					
648342	<i>ALPHA ACTIVE 3 MR 80 PU</i>	648345	N/A		780 (30 3/4")	
648321W	<i>ALPHA ACTIVE 3 MR 90 welded</i>	N/A	648430W		857 (33 3/4")	
648343W	<i>ALPHA ACTIVE 3 MR 90 PU welded</i>					
648323W	<i>ALPHA ACTIVE 3 MR 85 welded</i>	N/A	648460W		794 (31 1/4")	
648325W	<i>ALPHA ACTIVE 3 MR 85 PU welded</i>					
648342W	<i>ALPHA ACTIVE 3 MR 80 PU welded</i>	N/A	648345W		780 (30 3/4")	

CLEANING SYMBOLS			
	Recommended wash temperature: 15 min at 60°C (140°F). Maximum wash temperature: 15 min at 95°C (203°F)		Tumble dry at 60°C (140°F) Maximum drying temperature 80°C (176°F)
	Recommended wash temperature: 15 min at 60°C (140°F). Maximum wash temperature: 15 min at 71°C (160°F)		Tumble dry at 60°C (140°F)
	Do not iron		Do Not Use Phenol-based cleaning Solutions
	Wipe all surfaces with cleaning solution, then wipe with a cloth moistened with water and dry thoroughly		Use solution diluted to 1000 ppm of Available Chlorine

COVER SPECIFICATION	
Feature	Reliant IS <sup>2</sup>
<b>Removable Cover</b>	Yes
<b>Moisture Vapour Permeable</b>	Low
<b>Low Friction</b>	No
<b>Water Resistant / Repellent</b>	Yes
<b>Polyurethane coating includes an antifungal agent to control microbial deterioration of fabric</b>	Yes
<b>Fire Retardant*</b>	BS 7175: 0,1 & 5
<b>2-Way Stretch</b>	Yes
<b>Recommended Wash Temperatures</b>	60°C (140°F) 15 min.
<b>Maximum Wash Temperatures</b>	Max 95°C (203°F) 15 min.
<b>Recommended Drying Temperatures</b>	60°C (140°F) or air dry
<b>Maximum Drying Temperatures</b>	Max 80°C (176°F)
<b>Wipedown Chemicals**</b>	Chlorine at strength of 1000ppm or Alcohol at 70% concentration; no phenol; ensure product is dry before storage

\* For additional flammability testing standards, refer to individual product law tags

\*\*Chlorine concentrations may vary from 250ppm to 10,000ppm depending on local policy and contamination status. If an alternative disinfectant is selected from the wide variety available, Arjo recommend that suitability for use is confirmed with the chemical supplier prior to use.

## Electromagnetic Compatibility (EMC)

Product has been tested for compliance with current regulatory standards regarding its capacity to block EMI (electromagnetic interference) from external sources.

Some procedures can help reduce electromagnetic interferences:

- Use only Arjo cables and spare parts to avoid increased emissions or decreased immunity which can compromise the correct functioning of the equipment.
- Ensure that other devices in patient-monitoring and/or life-support areas comply to accepted emissions standards.

### WARNING

**Wireless communications equipment such as wireless computer network devices, mobile phones, cordless telephones and their base stations, walkie-talkies, etc. Can affect this equipment and should be kept at least 1.5 m away from the equipment.**

Intended Environment: Home Healthcare Environment and Professional Healthcare facility environment.

Exceptions: HF Surgical Equipment and the RF Shielded room of an ME SYSTEM for magnetic resonance imaging.

### WARNING

**Use of this equipment adjacent to or stacked with other equipment should be avoided because it could result in improper operation. If such use is necessary, this equipment and the other equipment should be observed to verify that they are operating normally.**

#### Guidance and manufacturer's declaration - electromagnetic emissions

Emissions Test	Compliance	Guidance
RF emissions CISPR 11	Group 1	This equipment uses RF energy only for its internal functions. Therefore its RF emissions are very low and are not likely to cause any interference in nearby electronic equipment.
RF emissions CISPR 11	Class B	
Harmonic emissions	Class A	
IEC 61000-3-2	Complies	This equipment is suitable for use in all establishments, including domestic establishments and those directly connected to the public low voltage power supply network that supplies buildings used for domestic purposes.
Voltage fluctuations/flicker emissions		
IEC 61000-3-3		

Guidance and manufacturer's declaration - electromagnetic immunity			
Immunity Test	IEC 60601-1-2 test level	Compliance Level	Electromagnetic environment - guidance
Electrostatic discharge (ESD) EN 61000-4-2	±2kV, ±4kV, ±8kV, ±15kV air  ±8kV contact	±2kV, ±4kV, ±8kV, ±15kV air  ±8kV contact	Floors should be wood, concrete or ceramic tile. If floors are covered with synthetic material the relative humidity level should be at least 30%
Conducted disturbances induced by RF fields EN 61000-4-6	3V in 0,15 MHz to 80 MHz  6V in ISM and amateur radio bands between 0,15 MHz and 80 MHz  80% AM at 1 kHz	3V in 0,15 MHz to 80 MHz  6V in ISM and amateur radio bands between 0,15 MHz and 80 MHz  80% AM at 1 kHz	Portable and mobile RF communications equipment should be used no closer to any part of the product, including cables, than 1.0 m, if the transmitter's output power rating exceeds 1W <sup>(a)</sup>  Field strengths from fixed RF transmitters, as determined by an electromagnetic site survey, should be less than the compliance level in each frequency range <sup>(b)</sup>
Radiated RF electromagnetic field EN 61000-4-3	Home Healthcare environment 10 V/m  80 MHz to 2,7 GHz  80% AM at 1 kHz	Home Healthcare environment 10 V/m  80 MHz to 2,7 GHz  80% AM at 1 kHz	Interference may occur in the vicinity of equipment marked with this symbol:  
Electrical fast transient/burst EN 61000-4-4	±1kV SIP/SOP ports  ±2kV AC port  100kHz repetition frequency	±1kV SIP/SOP ports  ±2kV AC port  100kHz repetition frequency	Mains power supply should be that of a typical commercial or hospital environment.
Power frequency Magnetic field EN 61000-4-8	30A/m	30A/m	Power frequency magnetic fields should be at levels characteristic of a typical location in a typical commercial or hospital environment.
Surge IEC 61000-4-5	±0,5kV ±1kV; ±2kV, AC Mains, Line to Ground  ±0,5kV ±1kV, AC Mains, Line to Line	±0,5kV ±1kV; ±2kV, AC Mains, Line to Ground  ±0,5kV ±1kV, AC Mains, Line to Line	Mains power quality should be that of a typical commercial or hospital environment.

**Guidance and manufacturer's declaration - electromagnetic immunity**

<p>Voltage dips, short interruptions and voltage variations on power supply input lines</p> <p>IEC 61000-4-11</p>	<p>0 % UT; 0,5 cycle At 0°, 45°, 90°, 135°, 180°, 225°, 270° and 315°</p> <p>0 % UT; 1 cycle and 70 % UT; 25/30 cycles Single phase: at 0°</p> <p>0 % UT; 250/300 cycle</p>	<p>0 % UT; 0,5 cycle At 0°, 45°, 90°, 135°, 180°, 225°, 270° and 315°</p> <p>0 % UT; 1 cycle and 70 % UT; 25/30 cycles Single phase: at 0°</p> <p>0 % UT; 250/300 cycle</p>	<p>Mains power quality should be that of a typical commercial or hospital environment. If the user of the pump requires continued operation during power mains interruptions, it is recommended that the pump be powered from an uninterruptible power supply or a battery.</p>
---	---	---	---

**NOTE**

*UT is the AC mains voltage prior to application of the test level.*

a) Field strengths from fixed transmitters, such as base stations for radio (cellular/cordless) telephones and land mobile radios, amateur radio, AM and FM radio broadcast and TV broadcast cannot be predicted theoretically with accuracy. To assess the electromagnetic environment due to fixed RF transmitters, an electromagnetic site survey should be considered. If the measured field strength in the location in which the product is used exceeds the applicable RF compliance level above, the product should be observed to verify normal operation. If abnormal performance is observed, additional measures may be necessary.

b) Over the frequency range 150 kHz to 80 MHz, field strengths should be less than 1 V/m.

Intentionally left blank

**AUSTRALIA**

Arjo Australia Pty Ltd  
78, Forsyth Street  
O'Connor  
AU-6163 Western Australia  
Tel: +61 89337 4111  
Free: +1 800 072 040  
Fax: + 61 89337 9077

**BELGIQUE / BELGIË**

Arjo NV/SA  
Evenbroekveld 16  
BE-9420 ERPE-MERE  
Tél/Tel: +32 (0) 53 60 73 80  
Fax: +32 (0) 53 60 73 81  
E-mail: info.belgium@arjo.be

**BRASIL**

Arjo Brasil Equipamentos Médicos Ltda  
Rua Marina Ciufuli Zanfelice, 329 PB02 Galpão  
- Lapa  
São Paulo – SP – Brasil  
CEP: 05040-000  
Phone: 55-11-3588-5088  
E-mail: vendas.latam@arjo.com  
E-mail: servicios.latam@arjo.com

**CANADA**

Arjo Canada Inc.  
90 Matheson Boulevard West  
Suite 300  
CA-MISSISSAUGA, ON, L5R 3R3  
Tel/Tél: +1 905 238 7880  
Free: +1 800 665 4831 Institutional  
Free: +1 800 868 0441 Home Care  
Fax: +1 905 238 7881  
E-mail: info.canada@arjo.com

**ČESKÁ REPUBLIKA**

Arjo Czech Republic s.r.o.  
Na Strži 1702/65  
140 00 Praha  
Czech Republic  
Phone No: +420225092307  
e-mail: info.cz@arjo.com

**DANMARK**

Arjo A/S  
Vassingerødvej 52  
DK-3540 LYNGE  
Tel: +45 49 13 84 86  
Fax: +45 49 13 84 87  
E-mail:  
dk\_kundeservice@arjo.com

**DEUTSCHLAND**

Arjo GmbH  
Peter-Sander-Strasse 10  
DE-55252 MAINZ-KASTEL  
Tel: +49 (0) 6134 186 0  
Fax: +49 (0) 6134 186 160  
E-mail: info-de@arjo.com

**ESPAÑA**

Arjo Ibérica S.L.  
Parque Empresarial Rivas Futura, C/Marie  
Curie 5  
Edificio Alfa Planta 6 oficina 6.1-.62  
ES-28521 Rivas Vacia, MADRID  
Tel: +34 93 583 11 20  
Fax: +34 93 583 11 22  
E-mail: info.es@arjo.com

**FRANCE**

Arjo SAS  
2 Avenue Alcide de Gasperi  
CS 70133  
FR-59436 RONCQ CEDEX  
Tél: +33 (0) 3 20 28 13 13  
Fax: +33 (0) 3 20 28 13 14  
E-mail: info.france@arjo.com

**HONG KONG**

Arjo Hong Kong Limited  
Room 411-414, 4/F, Manhattan Centre,  
8 Kwai Cheong Road, Kwai Chung, N.T.,  
HONG KONG  
Tel: +852 2960 7600  
Fax: +852 2960 1711

**ITALIA**

Arjo Italia S.p.A.  
Via Giacomo Peroni 400-402  
IT-00131 ROMA  
Tel: +39 (0) 6 87426211  
Fax: +39 (0) 6 87426222  
E-mail: Italy.promo@arjo.com

**MIDDLE EAST**

Arjo Middle East FZ-LLC  
Office 908, 9th Floor,  
HQ Building, North Tower,  
Dubai Science Park,  
Al Barsha South  
P.O Box 11488, Dubai,  
United Arab Emirates  
Direct +971 487 48053  
Fax +971 487 48072  
Email: Info.ME@arjo.com

**NEDERLAND**

Arjo BV  
Biezenwei 21  
4004 MB TIEL  
Postbus 6116  
4000 HC TIEL  
Tel: +31 (0) 344 64 08 00  
Fax: +31 (0) 344 64 08 85  
E-mail: info.nl@arjo.com

**NEW ZEALAND**

Arjo Ltd  
34 Vestey Drive  
Mount Wellington  
NZ-AUCKLAND 1060  
Tel: +64 (0) 9 573 5344  
Free Call: 0800 000 151  
Fax: +64 (0) 9 573 5384  
E-mail: nz.info@Arjo.com

**NORGE**

Arjo Norway AS  
Olaf Helsets vei 5  
N-0694 OSLO  
Tel: +47 22 08 00 50  
Faks: +47 22 08 00 51  
E-mail: no.kundeservice@arjo.com

**ÖSTERREICH**

Arjo GmbH  
Lemböckgasse 49 / Stiege A / 4.OG  
A-1230 Wien  
Tel: +43 1 8 66 56  
Fax: +43 1 866 56 7000

**POLSKA**

Arjo Polska Sp. z o.o.  
ul. Ks Piotra Wawrzyniaka 2  
PL-62-052 KOMORNIKI (Poznań)  
Tel: +48 61 662 15 50  
Fax: +48 61 662 15 90  
E-mail: arjo@arjo.com

**PORTUGAL**

Arjo em Portugal  
MAQUET Portugal, Lda.  
(Distributor Exclusivo)  
Rua Poeta Bocage n.º 2 - 2G  
PT-1600-233 Lisboa  
Tel: +351 214 189 815  
Fax: +351 214 177 413  
E-mail: Portugal@arjo.com

**SUISSE / SCHWEIZ**

Arjo AG  
Fabrikstrasse 8  
Postfach  
CH-4614 HÄGENDORF  
Tél/Tel: +41 (0) 61 337 97 77  
Fax: +41 (0) 61 311 97 42

**SUOMI**

Arjo Scandinavia AB  
Riihitontuntie 7 C  
02200 Espoo  
Finland  
Puh: +358 9 6824 1260  
E-mail: Asiakaspalvelu.finland@arjo.com

**SVERIGE**

Arjo International HQ  
Hans Michelsensgatan 10  
SE-211 20 MALMÖ  
Tel: +46 (0) 10 494 7760  
Fax: +46 (0) 10 494 7761  
E-mail: kundservice@arjo.com

**UNITED KINGDOM**

Arjo UK and Ireland  
Houghton Hall Park  
Houghton Regis  
UK-DUNSTABLE LU5 5XF  
Tel: +44 (0) 1582 745 700  
Fax: +44 (0) 1582 745 745  
E-mail: sales.admin@arjo.com

**USA**

Arjo Inc.  
2349 W Lake Street Suite 250  
US-Addison, IL 60101  
Tel: +1 630 307 2756  
Free: +1 800 323 1245 Institutional  
Free: +1 800 868 0441 Home Care  
Fax: +1 630 307 6195  
E-mail: us.info@arjo.com

**JAPAN**

Arjo Japan K.K.  
東京都港区虎ノ門三丁目7番8号 ランディイ  
ク第2虎ノ門ビル9階  
電話 : +81 (0)3-6435-6401

At Arjo, we are committed to improving the everyday lives of people affected by reduced mobility and age-related health challenges. With products and solutions that ensure ergonomic patient handling, personal hygiene, disinfection, diagnostics, and the effective prevention of pressure ulcers and venous thromboembolism, we help professionals across care environments to continually raise the standard of safe and dignified care. Everything we do, we do with people in mind.



ArjoHuntleigh AB  
Hans Michelsensgatan 10  
211 20 Malmö, Sweden  
[www.arjo.com](http://www.arjo.com)

**arjo**



648934EN

**CE**  
2797