

INSTRUCTIONS FOR USE

Auto Logic



WARNING

To avoid injury, always read this Instructions for Use and accompanied documents before using the product.



Mandatory to read the Instructions for Use

Design Policy and Copyright

® and ™ are trademarks belonging to the Arjo group of companies.

© Arjo 2019.

As our policy is one of continuous improvement, we reserve the right to modify designs without prior notice. The content of this publication may not be copied either whole or in part without the consent of Arjo.

Contents

General Safety	iii
Introduction	1
About this Manual	1
Intended Use	1
About Auto Logic	1
Clinical Applications	6
Indications	6
Contraindications	6
Cautions	6
Care of the Patient When Sitting	6
Installation	7
Preparing the Systems for Use	7
Installing the Mattress	7
To Complete the Mattress Installation	8
Installing the Pump	9
Installing the Aura Logic Seat Cushion	10
Controls, Alarms and Indicators	12
Controls	12
Alarms and Indicators	13
Operation	15
Quick Start	15
Comfort Control	16
Autofirm	16
Power Fail Condition	17
To Disconnect the Tubeset	17
Transport Mode	17
Shut Down	17
To Deflate and Store the Auto Logic Mattress	18
To Deflate the Aura Logic Seat Cushion	18
CPR Control	19
Battery Pack	20
Installing the Battery Pack	20
Checking the Status of the Battery Pack	21
Charging the Battery Pack	22
Battery Storage and Disposal	23
Decontamination	24
Routine Maintenance	25
Auto Logic and Aura Logic Systems	25
Auto Logic and Aura Logic Pump	25

Auto Logic 110, 175 & 200 Mattresses and Aura Logic Seat Cushion	25
Serial Labels	25
Troubleshooting & Alarm Condition.26
Technical Description27

General Safety

Before you connect the system pump to a mains socket, read carefully all the installation instructions contained within this manual.

The system has been designed to comply with regulatory safety standards including:

- EN60601-1:2006/A1:2013 and IEC 60601-1:2005/A1:2012.
- EN60601-1-11:2010; IEC 60601-1-11:2010 and IEC60601-1-8:2012.
- ANSI/AAMI ES 60601-1(2005)+AMD(2012)and CAN/CSA-C22.2 No.60601-1(2008)+(2014).

Safety Warnings

- **It is the responsibility of the care giver to ensure that the user can use this product safely.**
- **Whilst the patient is unattended, the decision to use safety sides should be based on clinical assessment and in line with local policy.**
- **Alignment of the bed frame, safety sides and the mattress should leave no gap wide enough to entrap a patient's head or body, or to allow egress to occur in a hazardous manner where entanglement with the mains power cable and tubeset or air hoses may result. Care should be exercised to prevent occurrence of gaps by compression or movement of the mattress. Death or serious injury may occur.**
- **Make sure that the mains power cable and tubeset or air hoses are positioned to avoid causing a trip or other hazard, and are clear of moving bed mechanisms or other possible entrapment areas. The mains power cable of this pump is designed to allow movement of the bed, and should be fitted into the cable management flaps along the sides of the mattress, as described in this manual.**
- **When using a seat cushion, the tubeset may be a trip hazard; position the tubeset so that it does not create a trip hazard, and always supervise babies and small children when the product is in use.**
- **Electrical equipment may be hazardous if misused. There are no user-serviceable parts inside the pump. The pump's case must only be removed by authorised technical personnel. No modification of this equipment is allowed.**
- **The mains power socket/plug must be accessible at all times. To disconnect the pump completely from the electricity supply, remove the plug from the mains power socket.**
- **The CPR control and/or the CPR indicator tag must be visible and accessible at all times.**
- **Disconnect the pump from the mains power socket before cleaning and inspecting.**
- **Keep the pump away from sources of liquids and do not immerse in water.**
- **Do not use the pump in the presence of uncontained flammable liquids or gasses.**
- **The cover of this product is vapour permeable but not air permeable and may present a suffocation risk.**
- **Do not use the mattress without a cover, it provides a protective barrier.**
- **Bags supplied with this equipment may present a suffocation risk; to avoid the risk of suffocation keep the bags away from babies and small children.**
- **There is no Transport facility on the seat cushion.**
- **Only the pump and mattress combination as indicated by Arjo should be used. The correct function of the product cannot be guaranteed if incorrect pump and mattress combinations are used.**

- The battery socket cover on the bottom of the pump must be retained in position at all times. If there is a need to remove it, then it should be stored in a safe place away from babies and small children for subsequent reinstalling.
- Due to the inherently lower flame retardancy of the high performance Ventilate IS² fabric, it is NOT suitable for use in the homecare environment.
- The operator should stay around the pump to prevent from missing the system alarm.
- If a serious incident occurs in relation to this medical device, affecting the user, or the patient then the user or patient should report the serious incident to the medical device manufacturer or the distributor. In the European Union, the user should also report the serious incident to the Competent Authority in the member state where they are located.

Side Rails / Patient Restraints

- Whether and how to use side rails or restraints is a decision that should be based on each patient's needs and should be made by the patient and the patient's family, physician and caregivers, with facility protocols in mind.
- Caregivers should assess risks and benefits if side rail / restraint use (including entrapment and patient falls from bed) in conjunction with individual patient needs, and should discuss use of non-use with patient and / or family. Consider not only the clinical and other needs of the patient but also the risks of fatal or serious injury from falling out of bed and from patient entrapment in or around the side rails, restraints and other accessories.
- In the US, for a description of entrapment hazards, vulnerable patient profile and guidance to further reduce entrapment risks, refer to FDA's Hospital Bed System Dimensional and Assessment Guidance To Reduce Entrapment.
- Outside the US, consult the local competent authority or government agency for Medical Device Safety for specific local guidance. Consult a caregiver and carefully consider the use of bolsters, positioning aids or floor pads, especially with confused, restless or agitated patients.
- Make sure a capable patient knows how to get out of bed safely (and, if necessary, how to release the side rails) in case of fire or other emergency. Monitor patients frequently to guard against patient entrapment.



When selecting a mattress and overlay combination or MRS, ensure the distance between the top of side rails (if used) and patient surface (without compression) is at least 8.66 in (220 mm) to help prevent inadvertent bed exit or falls. Consider individual patient size, position (relative to the top of the side rail) and patient condition in assessing fall risk.

Safety Warnings - Battery Pack (Optional)

THE BATTERY PACK IS NOT SUITABLE FOR USE IN THE HOMECARE ENVIRONMENT. The following instructions are important for the safe use of the battery pack and to keep the user (resident/care giver) from harm:

- The battery pack BBP600 for the Auto Logic[®] pump is rechargeable. For maximum battery life, charge the battery at least once every five months when the product is not in use.
- Only use the battery pack designed for use with the pump. If unsure, do not use the battery pack. Make sure the battery pack belongs to the pump by comparing the

battery pack label with the “Technical Description” on page 27. If the battery pack type cannot be confirmed, contact your local Arjo office.

- **Do not expose the battery pack or charger to open flames.**
- **Do not expose the battery pack connector to water.**
- **To avoid bodily injury, do not crush, puncture, open, dismantle or otherwise mechanically interfere with the battery pack.**
- **Should the battery pack casing crack and cause contents to come in contact with skin or clothing, rinse immediately with plenty of water.**
- **If contents come in contact with the eyes, rinse immediately with plenty of water and seek medical attention.**
- **Inhalation of the contents can cause respiratory irritation. Provide fresh air and medical attention.**
- **Stop using the battery pack if any damage or deformation is noted. Contact your local Arjo office before further use.**
- **Refer to the “Battery Storage and Disposal” on page 23 for the correct disposal and recycling of the battery pack.**

Precautions

For your own safety and the safety of the equipment, always take the following precautions:

- Placing extra layers between the patient and the mattress potentially reduces the benefits provided by the mattress and should be avoided or kept to a minimum. As part of sensible pressure area care, it is advisable to avoid wearing clothing which may cause areas of localised high pressure due to creases, seams, etc. Placing objects in pockets should be avoided for the same reason.
- Do not expose the system, especially the mattress, to naked flames, such as cigarettes, etc.
- In the event of a fire, a leak in the seat or mattress could propagate the fire.
- Do not store the system in direct sunlight.
- Do not use phenol-based solutions to clean the system.
- Make sure the system is clean and dry prior to use or storage.
- Never use sharp objects or electrically heated under blankets on or under the system.
- Store the pump and mattress in the protective bags supplied.
- Pets and children must be supervised in the vicinity of the system.

Electromagnetic Compatibility (EMC)

This product complies with the requirements of applicable EMC Standards. Medical electrical equipment needs special precautions regarding EMC and needs to be installed in accordance with the following instructions:

- The use of accessories not specified by the manufacturer may result in increased emissions by, or decreased immunity of, the equipment, affecting its performance.
- Portable and mobile radio frequency (RF) communications equipment (e.g. mobile/cell phones) can affect medical electrical equipment.
- If this equipment needs to be used adjacent to other electrical equipment, normal operation must be checked before use.
- For detailed EMC information contact Arjo service personnel.

Environmental Protection

Incorrect disposal of this equipment and its component parts, particularly batteries or other electrical components, may produce substances that are hazardous to the environment. To minimise these hazards, contact Arjo for information on correct disposal.

Expected Service Life

The *Auto Logic* pump has an expected service life of seven years. To maintain the condition of the pump, have the pump serviced regularly according to the schedule recommended by Arjo.

Do NOT use unapproved accessories or attempt to modify, disassemble or otherwise misuse the *Auto Logic* system. Failure to observe this caution could result in injury, or in extreme cases, death.

End of Life Disposal

- Fabric material used on the mattresses or any other textiles, polymers or plastic materials etc. should be sorted as combustible waste.
- Mattresses at the end of life should be disposed of as waste according to the national or local requirements which may be landfill or combustion.
- Pump units have electrical and electronic components should be disassembled and recycled per Waste of Electrical and Electronic Equipment (WEEE) or in accordance with local or national regulation.

1. Introduction

About this Manual This manual is your introduction to the *Auto Logic* Dual Mode support systems and the *Aura Logic*[®] seat cushion. You must read and fully understand this manual before using the system.

Use this manual to initially set up the mattress or seat cushion, keep it as a reference for day-to-day routines and as a guide to maintenance.

If you have any difficulties in setting-up or using the *Auto Logic* and *Aura Logic* systems, contact your Arjo sales office, listed at the end of this manual.

Intended Use The intended use of this product is to prevent and/or manage pressure ulcers for patients up to 200 kg (440 lb).

The *Auto Logic* system should be used as part of a prescribed plan of care (refer to “Indications” on page 6).

About *Auto Logic* The *Auto Logic* systems comprise a mattress replacement, overlay or seat cushion, all operated by the same pump. The pump incorporates Self Set Technology (SST), which adjusts air pressure every 10 minutes for the Active (Alternating) mode and 20 minutes for the Reactive (Constant Lower Pressure) (CLP) mode to suit the Body Mass Index (BMI) and position of the patient. Both support systems can be used on standard hospital beds. The device can be used in the home care environment.

A full technical description of the *Auto Logic* system can be found in the Service Manual, part number SER0006, available from your Arjo sales office.

***Auto Logic* Pump** The *Auto Logic* pump comprises a moulded case with non slip feet on the base and rear and integral hanging brackets.

The controls are situated on the top of the pump and a sophisticated alarm system differentiates between normal operation and genuine system faults. If an alarm situation is detected an indicator illuminates on the top and front of the pump and an audible warning sounds.

The Autofirm system, once activated, creates a temporary firm surface to allow nursing procedures to be performed.

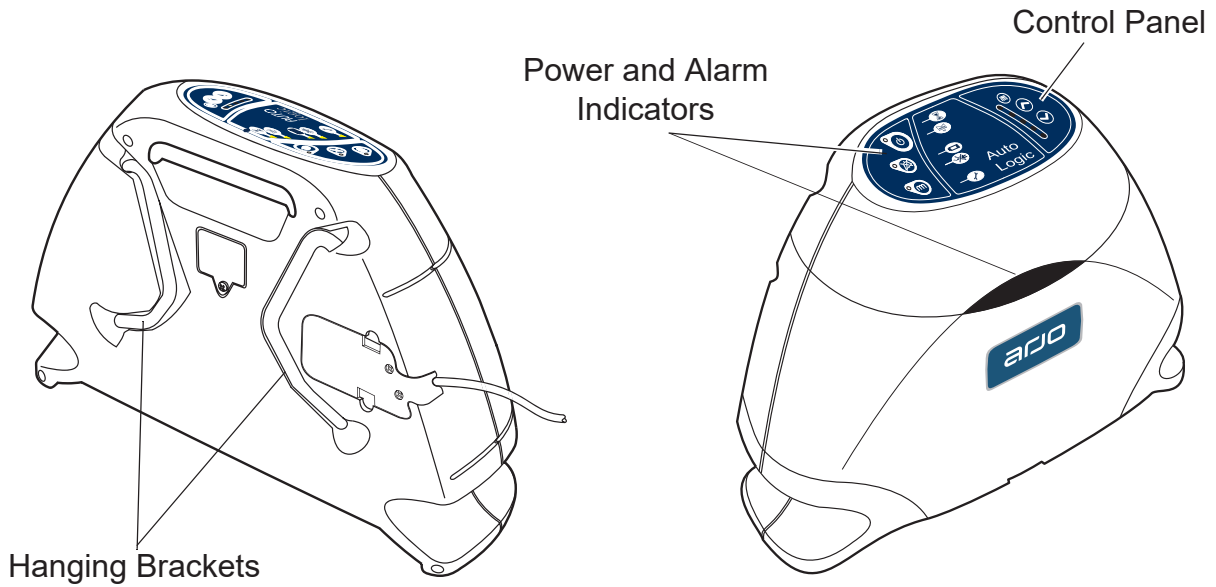

Auto Logic 110 Mattress Overlay The *Auto Logic 110* mattress overlay comprises the following components:

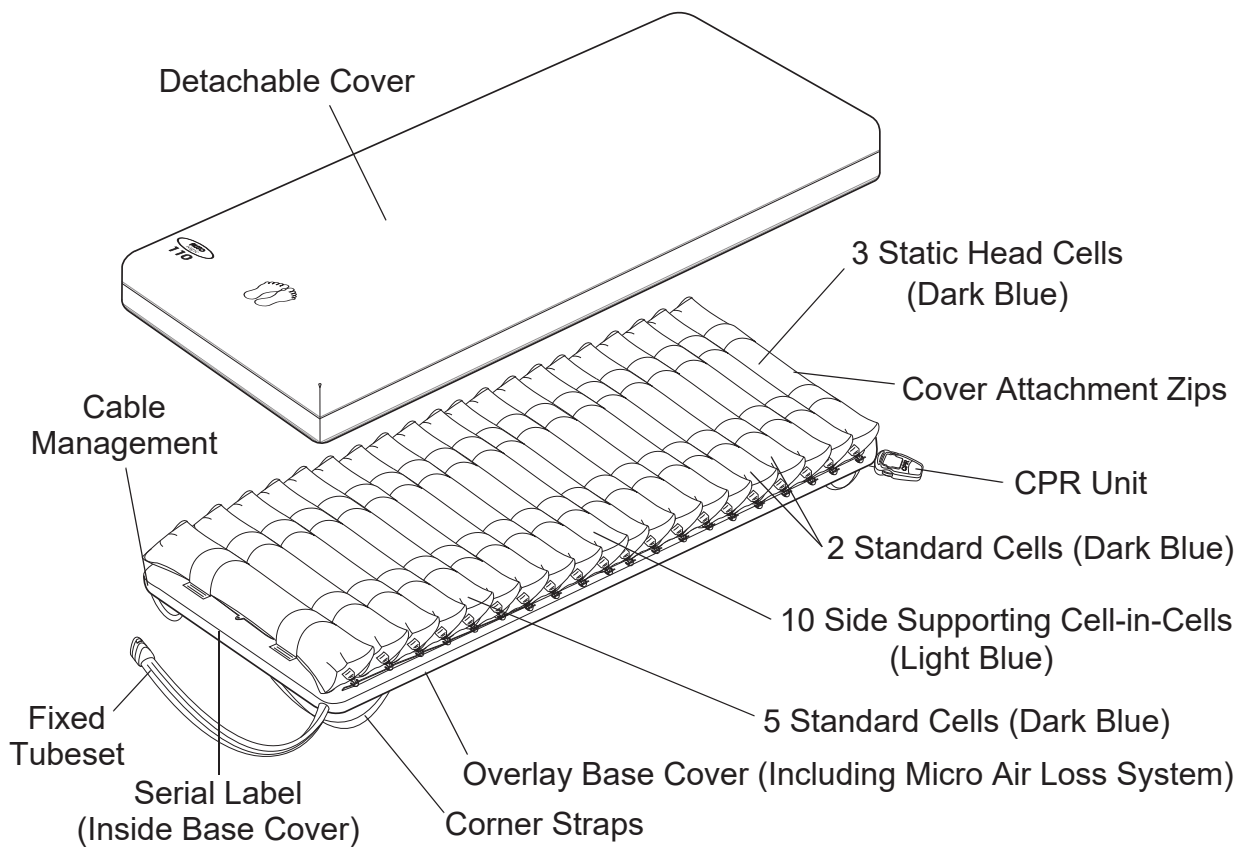

Detachable Cover The standard cover comprises a 2-way stretch PU coated knitted fabric zipped to a durable polyester base. The zips are protected by flaps to prevent ingress of contaminants and allow easy removal of the cover for cleaning.

Alternative covers with advanced properties, such as Glide IS² and Ventilate IS² are also available (Refer to “COVER SPECIFICATION” on page 30).

Cells The mattress comprises 20 polyurethane (PU) cells providing support to the user in either Active (Alternating) or Reactive (Constant Lower Pressure) modes. The cells are slightly curved to reduce patient movement down the mattress.

The side supporting cells incorporate Cell-in-Cell technology to help the transfer of patients on and off the bed by keeping the edges of the mattress firm.

Micro Air Loss System A micro air loss system is incorporated into the base cover which de-humidifies the air surrounding the cells to reduce heat build up within the mattress and ensure patient comfort. This system is separate from the cell inflation to enable both micro air loss and patient transport modes to be incorporated into the mattress.

CPR Function A CPR (Cardio-Pulmonary Resuscitation) control is positioned at the head end of the mattress to enable the air to be evacuated in under 10 seconds.

Tubaset The tubaset has a 3-way pneumatic connection which incorporates a flexible, compact anti-kink tube that is resistant to crushing and any subsequent obstruction of air flow.

NOTE

If the tubaset is disconnected from the pump, the mattress automatically changes to Transport mode.

Overlay Base Cover The base cover for the mattress overlay is PU coated polyester on the underside. Four corner retention straps are incorporated, which slide under the corners of the base mattress.

Auto Logic 175 & 200 Mattress Replacement

The *Auto Logic* 175 & 200 mattress replacements are of a similar construction to the overlay with the addition of a non-slip base. Within the non-slip base, the 175 mattress includes a foam underlay and the 200 mattress has an air filled zoned sub-mattress both of which replace the need for a mattress on the bed. The base can be removed to convert the mattress replacement to an overlay, refer to Arjo for more information.

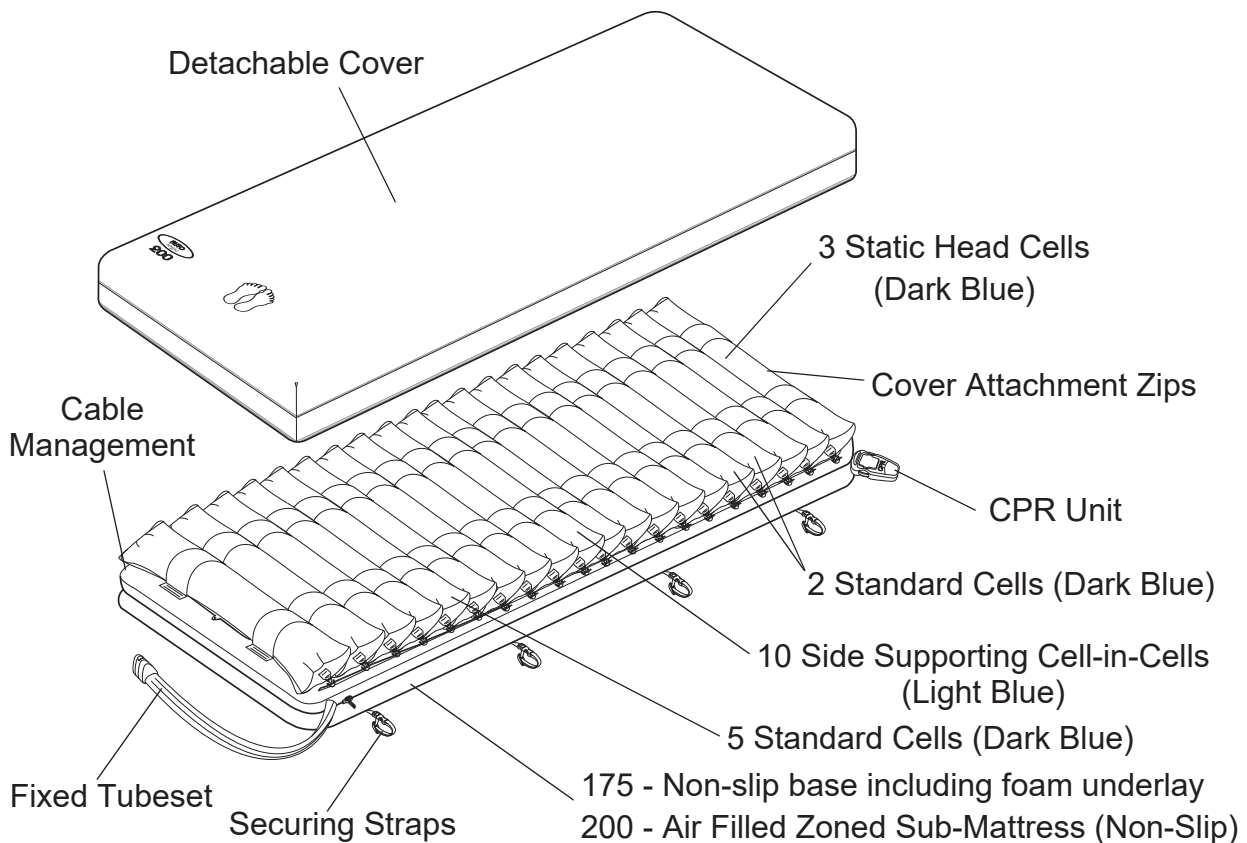

Air Sub-Mattress (200 Only)

The Sub-Mattress provides an integral constant pressure support which removes the need for a standard mattress. The pressure in the central zone of the pad is automatically adjusted in line with the Active (Alternating)/Reactive (Constant Lower Pressure) (CLP) of the mattress. The pressure in the perimeter zone of the pad is maintained at a higher level to help transfer of patients on and off the bed.

On the underside of the Sub-Mattress there are eight straps to attach the mattress replacement to the bed frame. The straps can be moved to any of the 10 anchor points to allow attachment of the mattress to different bed frames.

Aura Logic Seat Cushion

The *Aura Logic* seat cushion is an Active (Alternating) pressure redistribution system that can be used on standard hospital chairs.

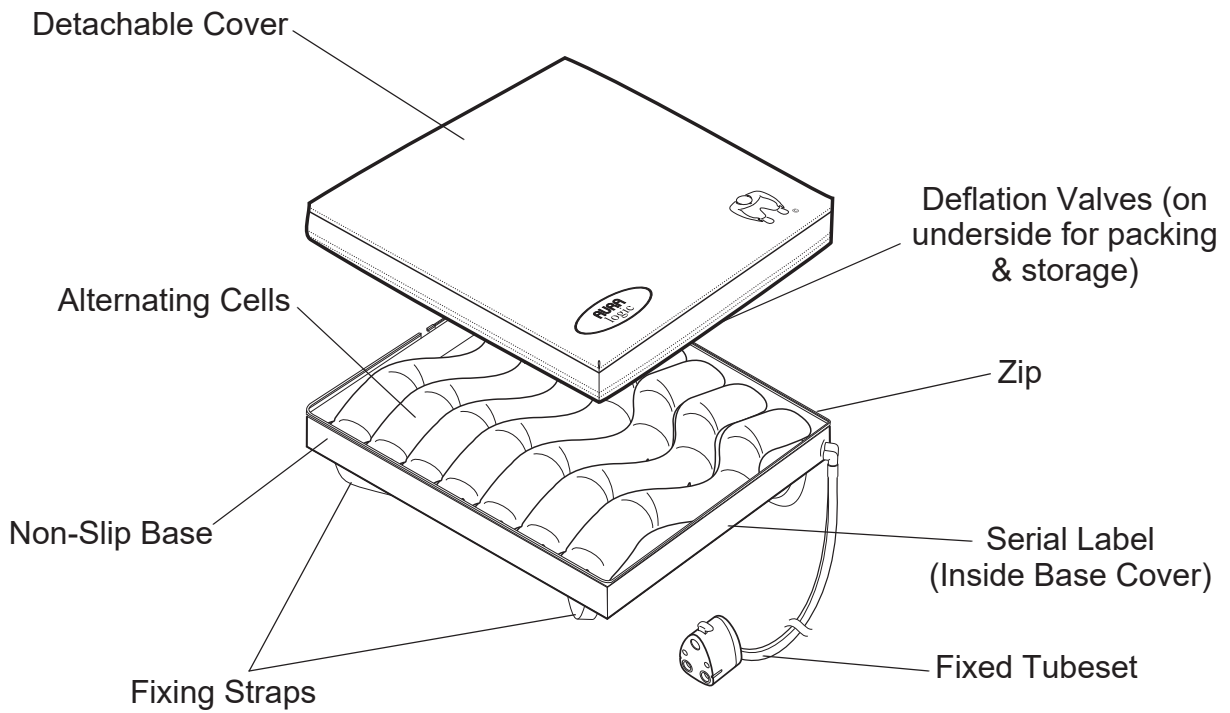

Caution

The optional battery pack is not suitable for use in the homecare environment.

Battery Pack (Optional)

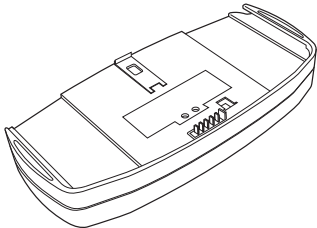

The Battery Pack is an optional extra that allows the pump to operate for a minimum of eight hours without a mains power supply.

The Battery Pack easily slides onto the base of the pump and will recharge itself when the pump is operating from the mains power supply.

2. Clinical Applications

Indications The *Auto Logic* systems are indicated for the prevention and/or management of all categories¹ of pressure ulcer, when combined with an individualised, comprehensive pressure ulcer protocol: for example, repositioning, nutritional support, skin care. Selection should be based upon a holistic assessment of the patient's individual care needs.

These systems represent one aspect of a pressure ulcer management protocol; all other aspects of care should be considered by the prescribing clinician.

If existing wounds do not improve or the patient's condition changes the overall therapy regimen should be reviewed by the prescribing clinician.

The above are guidelines only and should not replace clinical judgement.

The *Auto Logic* mattress and cushion are designed for patients weighing up to 200kg (440 lb).

Contraindications Do not use *Auto Logic* systems for patients with unstable spinal fractures.

Cautions If patients have other unstable fractures, or conditions which may be complicated by a soft or moving surface, advice should be sought from an appropriate clinician before use.

While the *Auto Logic* systems have been designed to manage patients up to the weight limits indicated above, those approaching this upper limit are likely to have additional care and mobility needs and may be better suited to a specialist bariatric system.

Active (Alternating) therapy cushions may be unsuitable for patients with poor sitting posture or pelvic deformity; advice from a seating specialist should be sought.

Care of the Patient When Sitting Seated patients are at increased risk of pressure ulcers particularly if they are immobile or have wounds over the seating area. For optimal outcome, provide a pressure redistributing seat cushion in a chair which promotes a good sitting posture and has a level base seat to support the cushion, in addition to an individualised repositioning programme.

NOTE

Mattress and cushion combinations may have different upper weight limits. Cushions should be used in combination with pressure-redistributing mattresses to provide 24-hour therapy.

1. NPUAP/EPUAP International Pressure Ulcer Guideline, 2009.

3. Installation

WARNING

Bags supplied with this equipment may present a suffocation risk; to avoid the risk of suffocation keep the bags away from babies and small children.

Preparing the Systems for Use

Remove the system from the packaging. You should have the following items:

- *Auto Logic* pump including mains power cord and hanging brackets.
- *Auto Logic* 110 mattress overlay, *Auto Logic* 175 or 200 mattress replacement or the *Aura Logic* seat cushion, which all have integral tubesets and covers.

NOTE

Do not use the mattress or seat cushion without the cover.

- Battery Pack (optional).

Installing the Mattress

Caution

Do not use the mattress overlay directly on the bed frame.

Auto Logic 110 Mattress Overlay

1. Place the overlay on top of the base mattress, with the tubeset located near the foot end of the bed and the CPR at the head end. The cells of the mattress must be uppermost.
2. Secure the overlay to the base mattress by placing and tightening the four long straps under the corners of the base mattress.

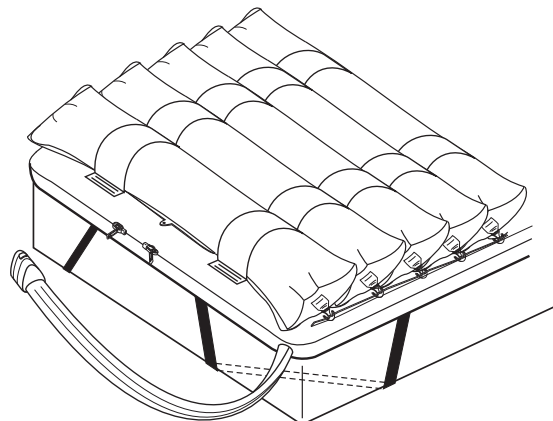

Auto Logic 175 or 200 Mattress Replacement

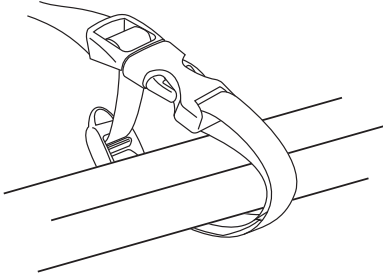

1. Remove the existing mattress from the bed frame and check that there are no protruding bed springs or sharp objects on the bed frame surface.
2. Unroll the mattress onto the bed frame and ensure that the tubeset is located near the foot end of the bed and the CPR at the head end. The cells of the mattress must be uppermost.
3. Attach the mattress to the bed frame using the eight fastener straps.

NOTE

- The eight fastener straps can be moved to any of the 10 anchor points on the base of the mattress replacement. This allows for attaching the mattress to different types of bed frame.
- If the bed can be profiled to any position (i.e. raised or lowered), attach the mattress to the movable parts of the bed only.
- Care should be taken at all times to check that tubes/lines are positioned correctly.

To Complete the Mattress Installation

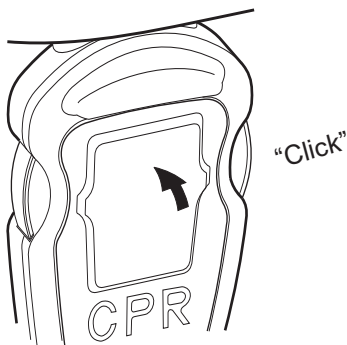

Complete the installation of the mattress overlay or the mattress replacement as follows:

1. If not already fitted, place the protective cover over the mattress. Ensure that the Arjo logo is uppermost and at the foot end of the mattress.
2. Zip the cover onto the mattress starting from the head end and taking care not to trap any material in the zip.
3. Ensure that the CPR unit is clicked into the closed position.

NOTE

The CPR must be accessible at all times.

WARNING

Make sure that the mains power cable is positioned to avoid causing a hazard and is clear of moving bed mechanisms or other possible entrapment areas. Refer to "Cable Management" on page 9.

Installing the Pump

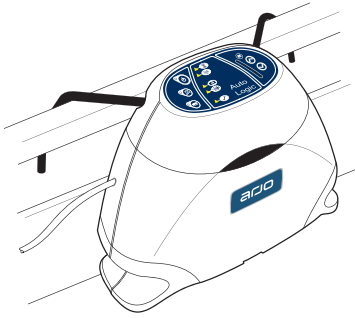

1. Position the pump, feet down, on any convenient horizontal surface or alternatively suspend from the bed foot rail by means of the swing out hooks.
2. Ensure that the mattress/seat tubeset is not “kinked” or twisted and connect it to the pump until it clicks into place. Ensure that the tubeset is securely connected to the pump.
3. Insert the mains power plug into a suitable mains power socket.

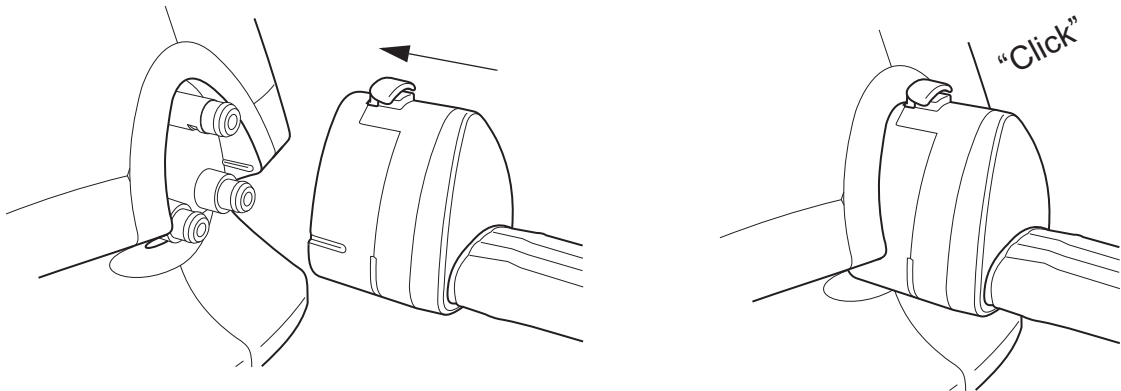

Battery Pack

If you have a battery pack, refer to “Installing the Battery Pack” on page 20.

Cable Management

If using the mattress replacement or mattress overlay, the power cable can be positioned in the cable management flap running down the side of the mattress as follows:

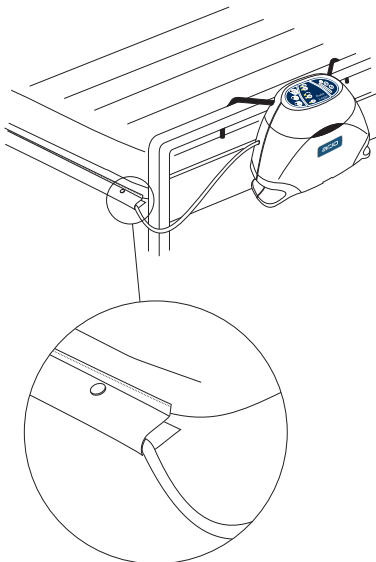

1. Locate the flap running along the mattress on the opposite side to the tubeset and CPR.
2. Run the straight part of the cable along the side of the mattress securing the flap round the cable using the press studs.

System Operation

The system is now ready for use. Refer to “Controls, Alarms and Indicators” on page 12 and “Operation” on page 15 for day-to-day operating instructions.

Installing the *Aura Logic* Seat Cushion

The system should be installed as follows:

1. Check that there are no sharp objects on the chair which may puncture the cushion.
2. Place the cushion on top of the chair surface. From a standing position in front of the chair and facing it, ensure that:
 - The cells are uppermost.
 - The tubeset appears from the front right corner of the cushion.
 - The cells in the seat cushion are in a horizontal position across the chair, with the 'V' shape pointing towards the front.

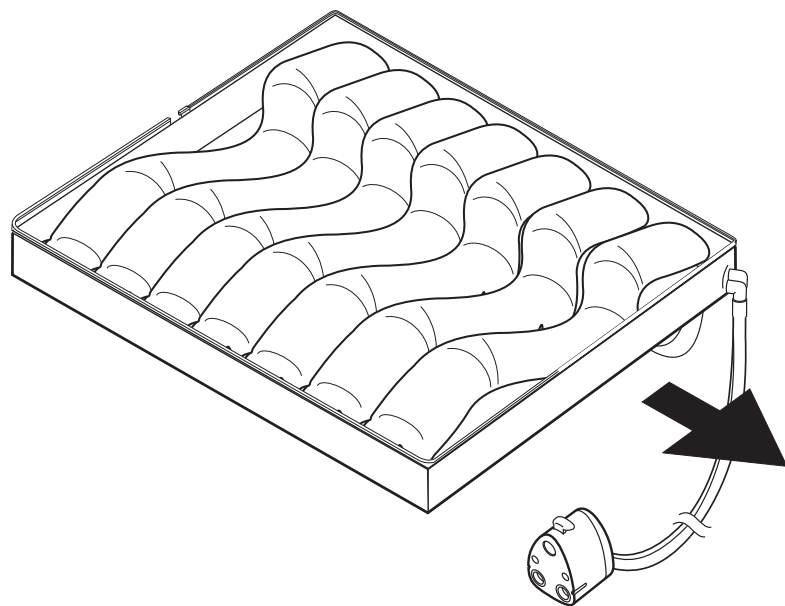

Cautions

- Do not use the *Aura Logic* seat cushion without a foam cushion beneath it.
- Always use the *Aura Logic* seat cushion with the protective top cover.
- Always use the *Aura Logic* seat cushion in the correct orientation.
- Avoid trailing cables - ensure that cables and tubing are positioned beneath the chair to avoid causing a hazard.
- Position the tubeset so it does not create a trip hazard and always supervise babies and small children when the product is in use.

3. Secure the seat cushion to the chair by using the fixing straps as shown in the following illustrations.
4. If the chair is of the open sided construction, then fix the cushion as shown below:

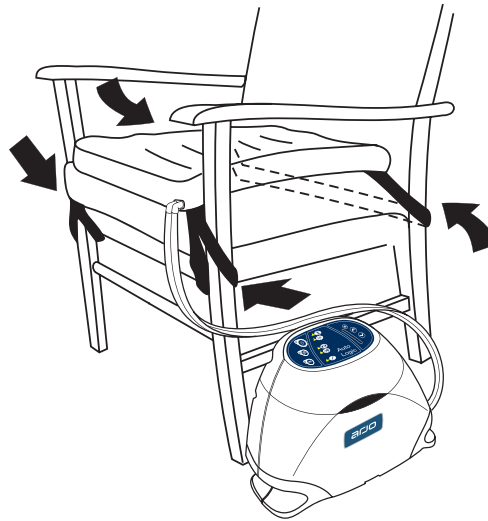

5. If the chair is of the closed side type with a removable seat cushion, fix the seat cushion as shown below:

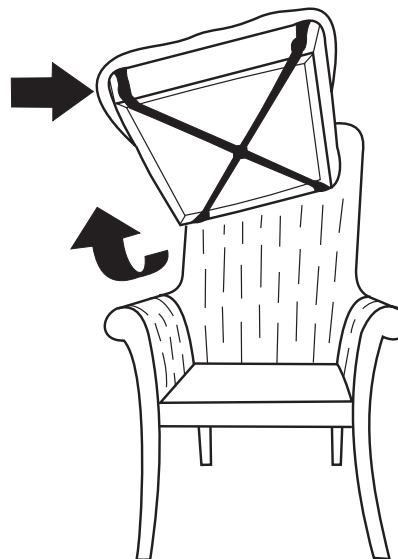

6. If the chair is of the closed side type with a non-removable seat cushion, then security will rely on the anti-slip base material of the seat cushion.
7. Place the protective cover over the seat cushion and ensure that the Arjo logo and the orientation icon, printed on the cover, are uppermost and at the front of the seat.
8. Zip the cover onto the seat cushion, taking care not to trap any material in the zip.
9. Connect to the *Auto Logic* pump, refer to page 9.

4. Controls, Alarms and Indicators

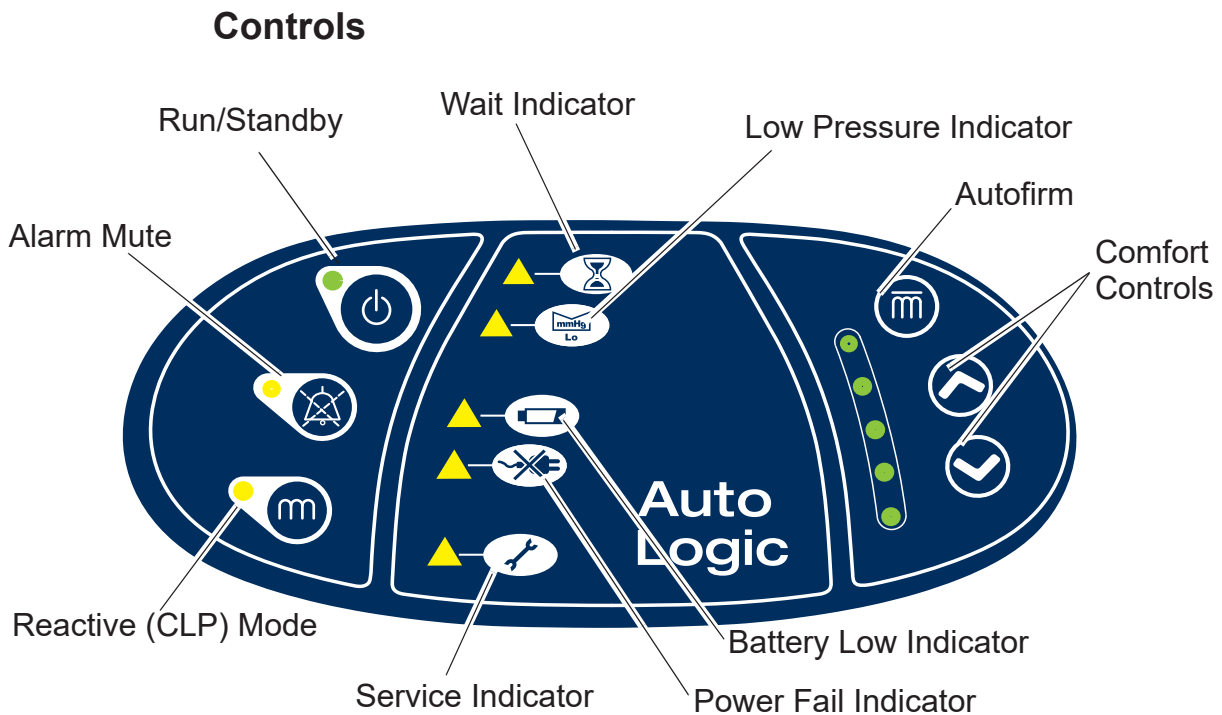

Run/Standby Button



Pressing the Run/Standby button will activate the pump. The green indicators on the control panel and the front of the pump will illuminate when the pump is on.

To switch the pump to Standby, the button must be pressed for two seconds. This prevents accidental operation.

The green indicator will blink twice every 2 seconds to indicate to the user that the pump is in Standby.

NOTE

Unless Transport mode is required, always put the pump into Standby before disconnecting mattress or seatpad.

Alarm Mute



During an alarm condition (except Power Fail Alarm), the sound of the alarm can be silenced by pressing this button. The yellow indicator then remains on but the alarms will be silenced for 15 minutes or until the alarm condition has been corrected.

Reactive (CLP) Mode



Selects the Reactive (Constant Lower Pressure) (CLP), non-alternating mode. The yellow indicator illuminates when the pump is in this mode. When the Active (Alternating) mode (default) is selected, the yellow indicator will be switched off.

Press the Reactive (CLP) Mode button for approximately 4 seconds to activate the reactive mode. The change in the mode will occur at the end of the next

complete alternating cycle, and so a maximum 10 minute delay may be experienced.

In the Reactive (CLP) mode the patient will not experience the benefits of Active (Alternating) therapy.

Autofirm Mode



Press and hold the Autofirm button for two seconds to enter Autofirm mode. Once activated, Autofirm creates a temporary firm surface to allow nursing procedures to be performed. Autofirm lasts 15 minutes, after which the pump will default back to the previous setting.

When the pump is in Autofirm mode the Reactive (CLP) and Comfort Control LEDs are illuminated.

NOTE

This operation does not function whilst a seat cushion is connected.

Comfort Control

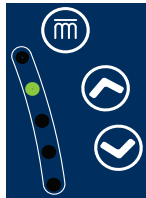

Two buttons control the relative firmness/softness of the mattress/seat cushion for patient comfort.

The pressure setting is indicated by the green indicator to the left of the buttons.

Alarms and Indicators

Wait Indicator



The yellow Wait indicator is illuminated when the mattress/seat is being inflated. The indicator remains illuminated until the mattress/seat has been fully inflated.

Low Pressure Indicator



The yellow Low Pressure indicator is illuminated whenever the pump detects low pressure within the mattress/seat. An audible alarm sounds unless silenced by the Alarm Mute button.

The indicator will extinguishes once normal pressure is reached.

NOTE

See "Troubleshooting & Alarm Condition" on page 26 for possible causes of Low Pressure.

Battery Low Indicator



The yellow Battery Low indicator will illuminate 2 hours before battery failure.

1 hour before battery failure, the pump will default to Reactive (CLP) mode, an audible alarm will sound and the yellow indicator will still illuminate.

Power Fail Indicator

The yellow Power Fail indicator illuminates when a mains power failure has been detected and no battery backup is available. An audible alarm sounds until power is resumed or the pump is switched off using the Run/Standby button.

If a Power Fail condition arises and no battery is connected, disconnect the tubeset from the pump. This will put the mattress into transport mode (Refer to page 17).

Service Indicator

The yellow Service indicator illuminates and remains on after a set number of running hours. This indicates that the pump is ready for a service. The pump will continue to function normally even when the service indicator is illuminated but you should arrange service as soon as is convenient.

If the yellow Service indicator illuminates, the pump has detected an internal fault and a Service Engineer should be called.

5. Operation

These instructions cover day-to-day operation of the system. Other operations, such as maintenance and repair, should only be carried out by suitably qualified personnel.

WARNING

Do not place the patient on the mattress until it is fully inflated and normal operating pressure has been reached.

Quick Start Before using any of the *Auto Logic* mattress or seat systems make sure it has been installed correctly in accordance with “Installation” on page 7 and ensure that the CPR unit on the mattress is clicked into the closed position.

Run/Standby

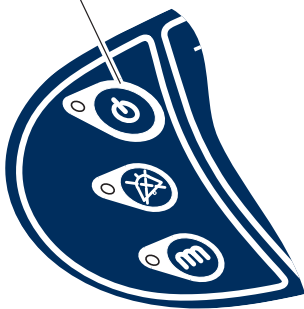

1. When the *Auto Logic* pump is switched on at the mains supply or a battery pack is connected, an audible beep sounds and a self-diagnostic check runs for approximately 10 seconds. When the check is complete a second audible beep sounds and the pump is ready for use.
2. Press the Run/Standby button on the control panel of the pump. The Run/Standby and Wait indicators will illuminate together with the comfort indicator and the green light on the front of the pump.
3. The Wait indicator will extinguish when the pump and mattress or seat cushion are ready for use. Approximate timings to inflate fully are:
 - 7 minutes for a mattress overlay
 - 15 minutes for a mattress replacement
 - 3 minutes for a seat cushion

NOTE

The Wait indicator extinguishes when the mattress/seat is fully inflated.

4. Place a bed sheet over the mattress and tuck in loosely. Ensure that the CPR unit is clearly visible at the head end of the bed.
5. You can now put the patient on the mattress.

NOTE

Once the patient is on the mattress, the pump automatically senses and adjusts the pressure in the cells using Self Set Technology (SST) to support the patient.

Comfort Control

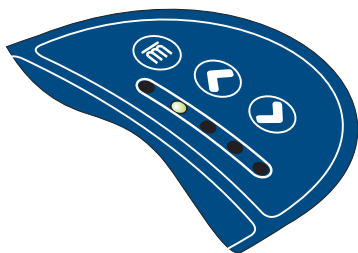

The mattress/seat cell pressure can be manually adjusted for patient comfort using the buttons on the pump control panel.

WARNING

Autofirm increases the volume of air in the mattress and therefore operation of the CPR function will take longer to deflate the mattress. If there is a risk of adverse patient reactions during clinical procedures then do not use Autofirm.

Autofirm The Autofirm mode allows the mattress to be pumped to a steady high pressure to allow nursing procedures that require a firmer base to be performed.

Autofirm mode lasts for 15 minutes but may be increased in 5 minute steps up to a maximum of 30 minutes.

Autofirm operation is only possible when a mattress is connected to the pump.

NOTE

This operation will not function whilst a seat cushion is connected.

To Activate Autofirm To activate the Autofirm mode hold the Autofirm button down for 2 seconds.

All comfort LEDs will flash while the pump configures itself for Autofirm.

The comfort LED's will illuminate in sequence while the mattress is being inflated to Autofirm pressures.

Once the mattress has reached pressure all comfort LEDs will remain illuminated, and the pump will beep three times. The Reactive (CLP) LED will also be illuminated.

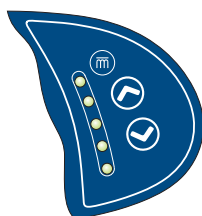

To De-Activate Autofirm To de-activate the Autofirm mode hold the Autofirm button down for 2 seconds.

To Extend Autofirm Duration

During the last minute of Autofirm all comfort LEDs will flash and the pump will sound a series of tones, which will increase in both pitch and frequency. During this alert period the Autofirm mode may be extended by a further 5 minutes by pressing either comfort key.

The maximum duration of Autofirm mode is 30 minutes.

Following the end of Autofirm the previous pump mode is restored.

Power Fail Condition

If a Power Fail condition arises and no battery is connected, disconnect the tubeset from the pump. This will put the mattress into Transport mode and will support the patient for up to 12 hours. Once power is resumed, re-connect the tubeset to the pump.

To Disconnect the Tubeset

To disconnect the tubeset at any time, push the button down and pull the tubeset connector away from the pump.

This puts the mattress into Transport mode but does not deflate the mattress. To deflate the mattress Refer to page 18.

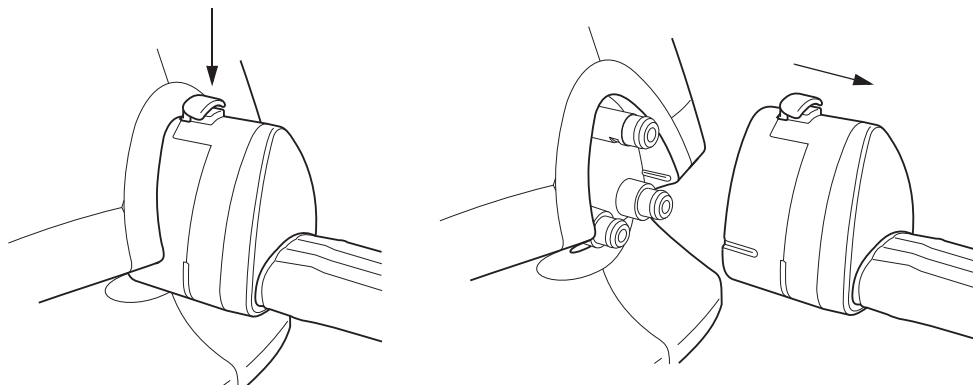

Transport Mode



To transport a patient using the *Auto Logic* mattress, disconnect the tubeset from the pump. This automatically switches the mattress into Transport mode.

The patient will remain supported by the mattress for up to 12 hours.

To resume normal operation, simply reconnect the tubeset and run the pump.

NOTE
There is no Transport mode on the *Aura Logic* seat cushion.

Shut Down Power the pump off by pressing the Run/Standby button for at least two seconds to select Standby (LED amber).
If you need to completely isolate the pump from the mains, remove the plug from the mains power socket.
If running from the battery pack, remove it from the pump.

To Deflate and Store the Auto Logic Mattress

To deflate the mattress:

1. Disconnect the tubeset from the pump.
2. Activate the CPR control to deflate the mattress.

To store the mattress Following deflation:

1. Bring the tubeset over the mattress to lie parallel to the foot end of the mattress.
2. Roll the mattress from the foot end toward the CPR connector at the head end of the mattress.

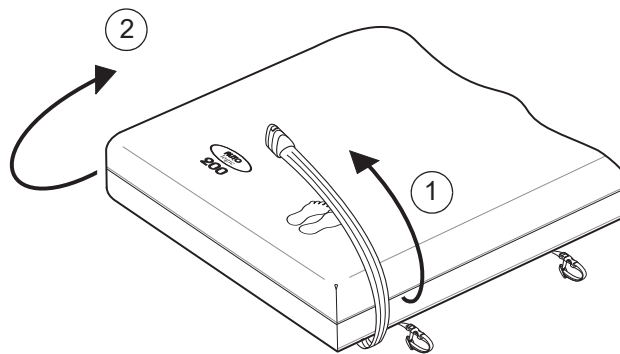

To Deflate the Aura Logic Seat Cushion

To deflate the seat cushion:

1. Disconnect the tubeset from the pump.
2. Push the two valves on the underside of the seat cushion.

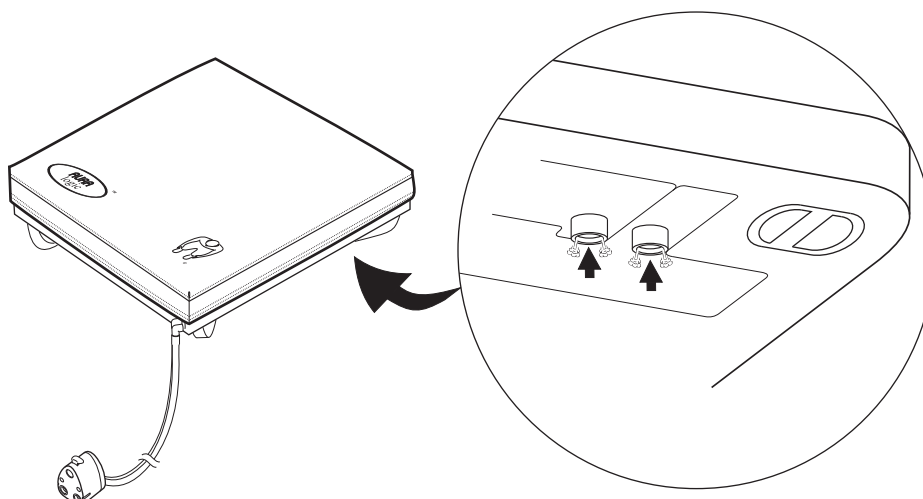

CPR Control

IMPORTANT IN THE EVENT OF CARDIAC ARREST

In the event of a patient suffering cardiac arrest and CPR needing to be administered:

To Activate CPR Press the two CPR release buttons simultaneously.

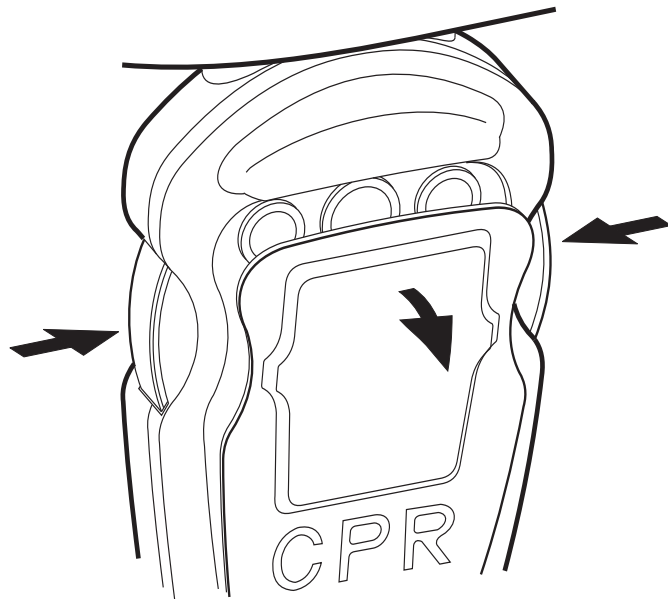

To Reset CPR Push the front of the CPR unit until it clicks into place.

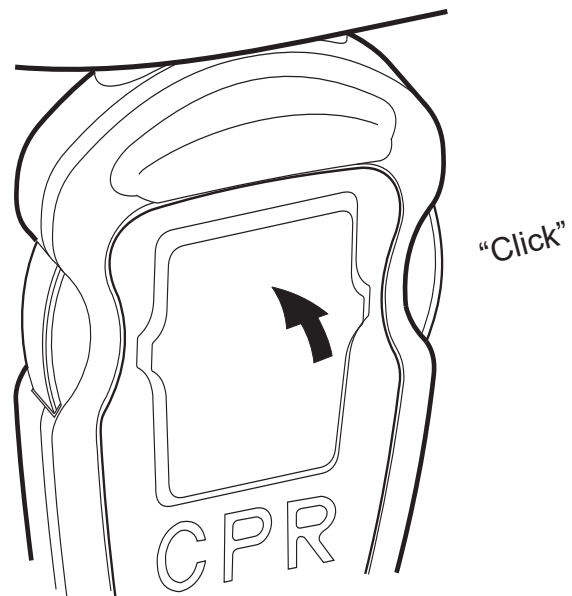

6. Battery Pack

Caution

The optional battery pack is not suitable for use in the homecare environment.

Installing the Battery Pack

Install the battery pack to the pump as follows:

1. Remove the battery socket cover from the base of the pump.

NOTE

Store it in a safe place away from babies and small children for subsequent reinstalling.

2. From the front of the pump, slide the battery pack over the guides on the base of the pump and click into place.
3. To remove the battery pack, depress the reset/status latch at the rear of the unit and slide the battery pack out from the base of the pump. Replace the battery socket cover on the base of the pump.

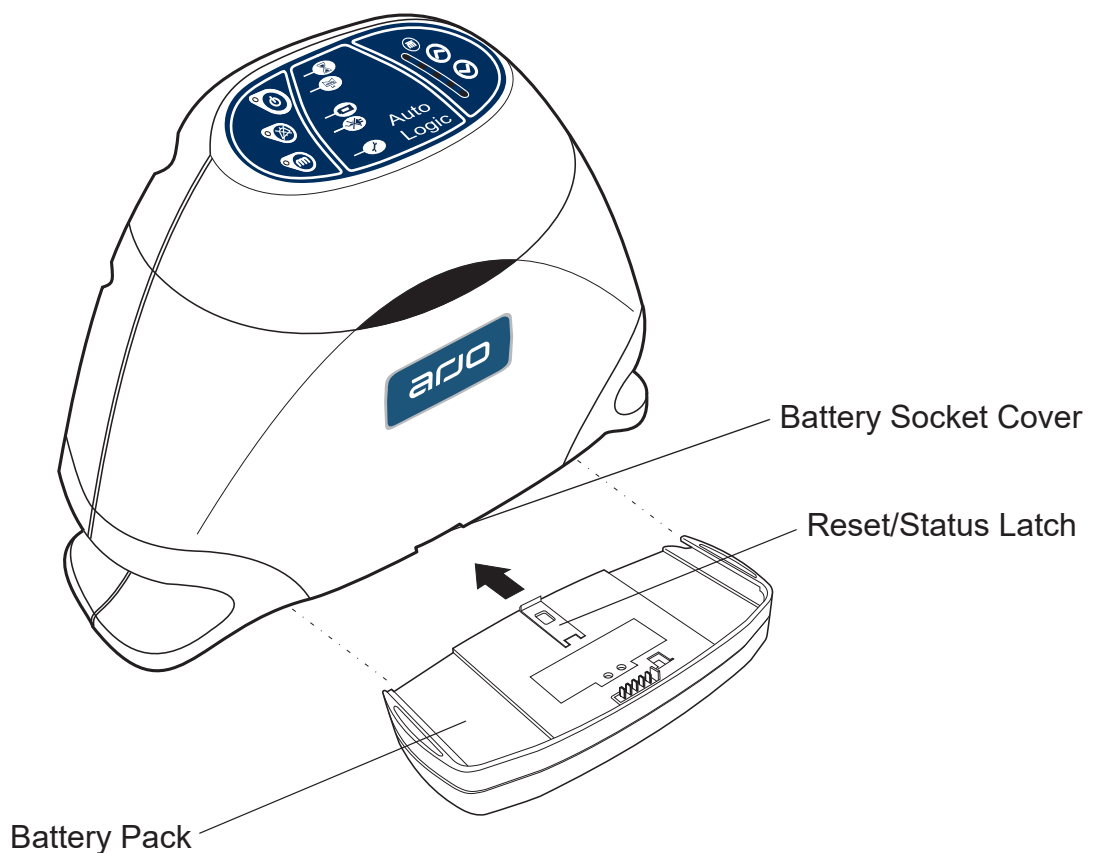

Checking the Status of the Battery Pack

Battery Label

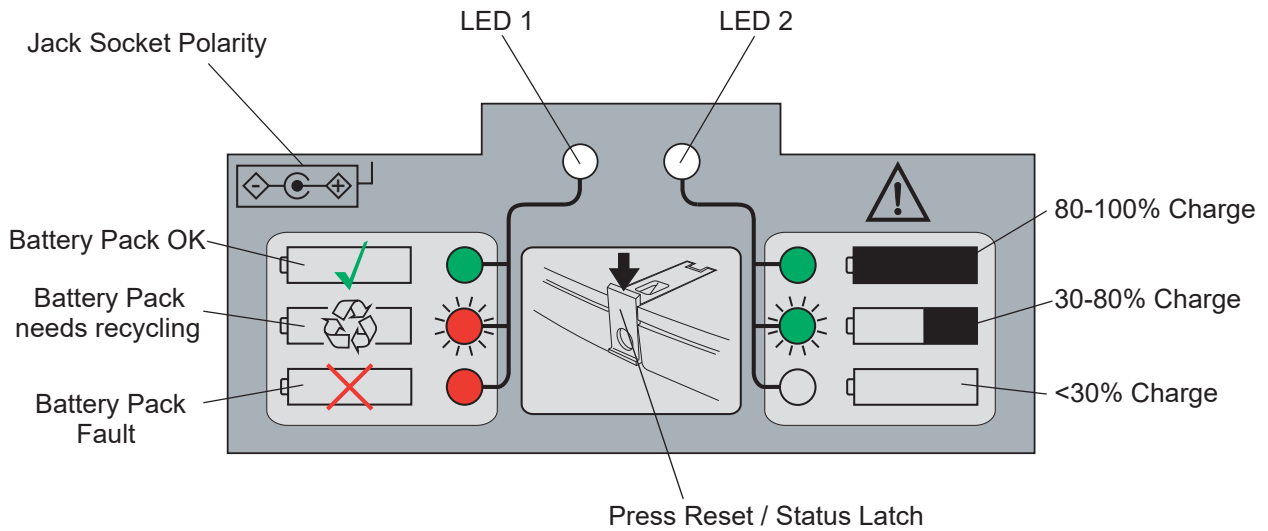

To Check the Battery Pack Status

To check the status of the battery pack:

1. Remove the battery pack from the pump unit.
2. Press the Reset/Status Latch, this activates the two LEDs on the top of the battery.

If the battery pack is not on charge the LEDs will display one of the following conditions:

LED 1	LED 2	Battery Status
Green ●	Green ●	The Battery Pack is OK. It has > 80% charge.
Green ●	Green ●☀	The Battery Pack is OK. It has between 30-80% charge.
Green ●	○	The Battery Pack is OK. It has < 30% charge.
Red ●☀	Green ●☀	The Battery Pack needs recycling ⁽¹⁾ . It has between 30-80% charge.
Red ●☀	○	The Battery Pack needs recycling ⁽¹⁾ . It has < 30% charge.
Red ●	○	The Battery Pack has an error.
○	○	The Battery Pack is flat or has an error. Try recharging.

1. Once the battery pack has entered the 'recycling' mode it will never show that the battery is fully charged (Note: this does not indicate a fault condition). It is recommended that the battery pack is sent back to an Arjo service centre for disposal (refer to "Battery Storage and Disposal" on page 23).

Charging the Battery Pack

The battery pack is automatically recharged whenever it is installed in a pump which is connected to an AC outlet. Alternatively the battery pack can be recharged away from the pump by plugging into the battery charger as shown below.

NOTE

It is normal for the battery pack and charger to get warm during use. Avoid charging the battery near source of heat or in direct sunlight

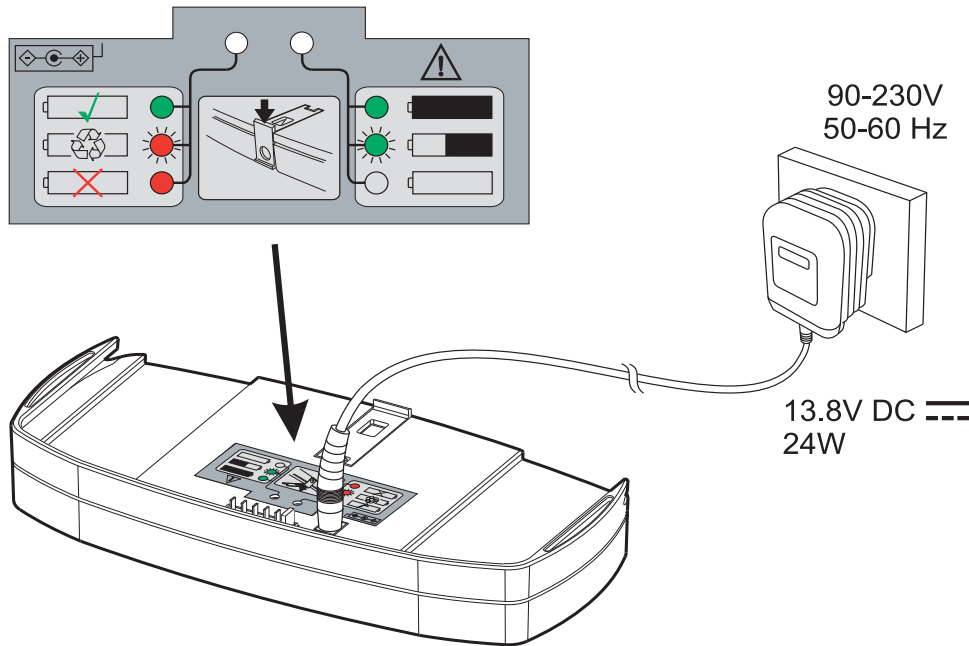

To ensure the long term performance of the battery pack, periodically run the pump using the battery pack until the pump switches off. This will fully discharge the battery pack. Fully recharge the battery pack before further use.

Typical service life of the battery is four years (500 charge/discharge cycles).

For safe handling and to extend the battery lifetime, follow and remember the instructions:

NOTE

Not following these instructions can cause short battery life and may, in extreme cases, put the user at risk.

- Only use the battery pack designed and labelled for use with the pump. When not sure, do **not** use the battery pack. Make sure the battery pack belongs to the pump by comparing the battery pack label with the “Technical Description” on page 27. If the battery pack type cannot be confirmed, contact Arjo.
- Battery pack life depends on many factors. Factors that can influence battery life are: frequency of use, frequency of charging, temperature of operation, storage and storage time.

- The expected battery pack lifetime depends on care. With correct care, frequent charging and storage at room temperature, the battery pack life can be prolonged. It is recommended that the battery pack is replaced every 2 years.

The Ni-MH battery pack should be totally discharged before being recharged in order to optimize its lifetime.

NOTE

For pump and mattress/seat cushion systems, periodically run the pump using the battery pack until the pump switches off. Fully recharge the battery pack before further use.

Make sure there is a replacement battery pack ready when needed. It is recommended that the facility department keep one in stock.

Battery Storage and Disposal

If the device is not to be used for an extended period, charge (refer to “Charging the Battery Pack” on page 22), remove and store the battery pack. If the battery packs are to be put into long term storage they should be recharged at least once every three to six months.

Faulty battery packs should be sent back to Arjo for recycling or correct disposal.

7. Decontamination

The following processes are recommended, but should be adapted to comply with the local or national guidelines (Decontamination of Medical Devices) which may apply within the Healthcare Facility or the country of use. If you are uncertain, you should seek advice from your local Infection Control Specialist.

The *Auto Logic* system should be routinely decontaminated between patients and at regular intervals while in use; as is good practice for all reusable medical devices.

WARNING

**Remove the electrical supply to the pump before cleaning by disconnecting the mains power cord from the mains power supply or removing the battery pack.
Protective clothing should always be worn when carrying out decontamination procedures.**

Caution

**Do not use Phenol-based solutions or abrasive compounds or pads during the decontamination process as these will damage the surface coating. Do not boil or autoclave the cover.
Avoid immersing electrical parts in water during the cleaning process. Do not spray cleaning solutions directly onto the pump.**

To Clean

Clean all exposed surfaces and remove any organic debris by wiping with a cloth moistened with a simple (neutral) detergent and water. Dry thoroughly.

Do not allow water or cleaning solutions to collect on the surface of the pump.

Chemical Disinfection

To protect the integrity of the cover we recommend a chlorine-releasing agent, such as sodium hypochlorite, at a strength of 1,000ppm available chlorine (this may vary from 250ppm to 10,000ppm depending on local policy and contamination status).

Wipe all cleaned surfaces with the solution, then wipe with a cloth moistened in water and dry thoroughly.

Alcohol based disinfectants (strength 70%) may be used as an alternative.

Ensure the product is dry before storage.

If an alternative disinfectant is selected from the wide variety available we recommend that suitability for use is confirmed with the chemical supplier prior to use.

Do not wring/mangle, autoclave or use phenolic based solutions.

Thermal Disinfection

For information for the mattress top cover, including laundering guidelines, refer to 'Cover Specification' table on page 30.

8. Routine Maintenance

Auto Logic and Aura Logic Systems

- Maintenance*** The equipment has been designed to be virtually maintenance-free between service periods.
- Servicing*** Arjo will make available on request service manuals, component parts lists and other information necessary for Arjo trained personnel to repair the system.
- Service Period*** Arjo recommend that the *Auto Logic* system should be serviced after 12 months continuous running time, by an Arjo authorised service agent. This is indicated by the illumination of the Service symbol.

Auto Logic and Aura Logic Pump

- General Care, Maintenance and Inspection*** Check all electrical connections and power cord for signs of excessive wear or damage.
- If the pump has been subjected to abnormal treatment, e.g. immersed in water or dropped, the unit must be returned to an authorised service centre.

Auto Logic 110, 175 & 200 Mattresses and Aura Logic Seat Cushion









- General Care*** Remove the top cover and inspect for signs of wear or any tears.
- Check all zips are secure.
- Check integrity of all connectors, including cell to manifold connections.
- Ensure all cell fasteners are correctly connected to the mattress base sheet and are not loose or damaged.

Serial Labels

- Pump*** The serial number for the pump is on the label on the back of the pump case.
- Mattress*** The mattress serial label can be found just inside the base cover above the tubeset, refer to the illustration on page 2.
- Seat Cushion*** The seat cushion serial label can be found just inside the front of the base cover, refer to the illustration on page 5.
- Quote this serial number when requesting service.

9. Troubleshooting & Alarm Condition

The following table provides a troubleshooting guide for the *Auto Logic* and *Aura Logic* systems in the event of malfunction. All the alarm conditions are low priority, compliance with 60601-1-8.









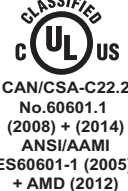

Indicator	Possible Cause	Remedy
<p>LOW PRESSURE</p>  <p>and WAIT</p> 	<ol style="list-style-type: none"> 1. The pump is inflating the mattress/seat. 2. CPR not fully closed. 	<ol style="list-style-type: none"> 1. Both indicators will extinguish when operating pressure is reached. 2. Close CPR unit.
<p>LOW PRESSURE</p> 	<ol style="list-style-type: none"> 1. The tubeset is not connected properly. 2. CPR not fully closed. 3. There is a leak in the system. 	<ol style="list-style-type: none"> 1. Check the tubeset connector and ensure it is securely fitted to the pump. 2. Close CPR unit. 3. Call service engineer.
<p>POWER FAILURE</p> 	<p>Power has been removed from the pump.</p>	<p>Re-apply power or switch the pump off.</p> <p>If the fully charged battery pack is fitted the pump will continue to operate for a minimum of 8 hours.</p>
<p>BATTERY LOW</p> 	<p>Low battery life.</p>	<p>Install a fully charged battery pack</p> <p>or</p> <p>Charge the battery by using mains power supply to run the pump.</p>
<p>SERVICE (ON)</p> 	<p>Pump needs a service.</p>	<p>Call service engineer.</p> <p>To find the serial numbers for the pump, mattress or seat refer to "Serial Labels" on page 25.</p>
<p>SERVICE (FLASHING)</p> 	<p>Pump has detected an internal fault.</p>	<p>Switch the pump off and call service engineer.</p>
<p>AUTOFIRM does not activate</p> 	<ol style="list-style-type: none"> 1. Seat pad in use. 2. Mattress in use. 	<ol style="list-style-type: none"> 1. Autofirm only available for use with mattresses. 2. Wait for 2 seconds before releasing Autofirm button.

NOTE

If the trouble shooting procedures do not return the system to normal performance, stop using the system immediately and call the service engineer.

10. Technical Description

PUMP	
Model:	<i>Auto Logic</i>
Part Numbers:	630009KSA KSA
Supply Voltage:	100-230 V 230 V
Supply Frequency:	50-60 Hz 60 Hz
Power Input:	28-68 VA
Size:	375mm x 280mm x 125mm (14.8" x 11" x 5 in.)
Weight:	3.9kg (8.6 lb) (no battery) 4.6kg (10.14 lb) (with battery)
Case Material:	ABS Plastic
Plug Fuse Rating:	5A to BS1362 (UK only)
Pump Fuse Rating:	2 x T3.15A H250V
Degree of protection against electric shock:	Mains Connected: Class II, Double Insulated without Functional Earth Type BF No Mains Connected: Internally Powered (Not Homecare)
Degree of protection against liquid ingress:	IP20 - (Non HomeCare) IP21 - (HomeCare, from serial number: 1500004716) Protection against ingress of solid objects more than 12.5mm diameter and water droplets falling vertically.
Mode of operation:	Continuous
Cycle Time:	10 Mins (Autofirm 15 mins to 30 mins)



PUMP					
	The operator must read this document (Instructions for Use) before use. Note: This symbol is blue on the product label.		Battery Low Indicator		Do not dispose of in domestic refuse
	With respect to electric shock, fire and mechanical hazards only in accordance with CAN/CSA-C22.2 No.60601.1 (2008) + (2014) and ANSI/AAMI ES60601-1 (2005)+AMD(2012). MEDICAL EQUIPMENT		Run/Standby. Note: Unit is not isolated from mains supply.		Type BF
	Refer to this document (Instructions for Use) for a description of the product classification (3rd Edition).	SN:	Serial Number	Ref:	Model number
	Refer to this document (Instructions for Use) for a description of the product classification (2nd Edition).		Manufacturer: This symbol is accompanied by the name and the address of the manufacturer.		Double Insulated
	Indicates the product is a Medical Device according to EU Medical Device Regulation 2017/745		CE marking indicating conformity with European Community harmonized legislation. Figures indicate Notified Body supervision.		

ENVIRONMENTAL INFORMATION			
Condition	Temperature Range	Relative Humidity	Atmospheric Pressure
Operating	+5°C to +40°C (+41°F to +104°F)	30% to 75% (non-condensing)	700hPa to 1060 hPa
Storage (Long Term)	+5°C to +40°C (+41°F to +104°F)	20% to 95% (non-condensing)	700 hPa to 1060 hPa
Storage (Short Term)	-20°C to +65°C (-4°F to +149°F)	20% to 95% (non-condensing)	500 hPa to 1060 hPa

NOTE

- If the pump is stored in conditions outside the “Operating” ranges, allow time for its temperature to stabilise to normal before use. Allow a minimum of 8 hours if the pump is stored at -20°C.
- One of the effects of prolonged exposure to high temperatures is to increase the self-discharge of the internal battery; this will reduce the duration of power fail alarms. The pump will fully charge the battery over a 24-hour period when the pump is connected to a mains power supply.

ACCESSORIES

Part:	Battery Pack
	NOTE: The battery pack is not suitable for use in the homecare environment.
Part Number:	BBP600
Weight:	0.8kg
Electrical Rating:	13.8V dc  4Ah (NiMH)
Symbols	
	Do not dispose of in domestic refuse
	Recycle

MATTRESS

Description	Cell Material	*Foam underlay size **Air-filled sub-mattress size	Base Pad Material
<i>Auto Logic 110</i>	Polyurethane	NA	NA
<i>Auto Logic 175</i>	Polyurethane	*2032 x 838 x 63.5mm (80" x 33" x 2 ½")	PU Laminate
<i>Auto Logic 200</i>	Polyurethane	**2030 x 860 x 90mm (80" x 34" x 3 ½")	PU Laminate









MATTRESS SIZE INFORMATION

Part No.	Description	Spare Cover	Length mm	Width mm	Weight Kg	Height mm
PXA001DAR	<i>Auto Logic 110</i> (Reliant IS ²)	PXA080	2030 (80")	860 (34")	7.5	115 (4 ½")
PXA201DAR	<i>Auto Logic 110 Narrow</i> (Reliant IS ²)	PXA280	2030 (80")	780 (30")	7.5	115 (4 ½")
PXB005DAR	<i>Auto Logic 175</i> (Reliant IS ²)	PXB180	2030 (80")	860 (34")	10.5	175 (7")
PXB001DAR	<i>Auto Logic 200</i> (Reliant IS ²)	PXB080	2030 (80")	860 (34")	10.5	205 (8")
PXB201DAR	<i>Auto Logic 200 Narrow</i> (Reliant IS ²)	PXB280	2030 (80")	780 (30")	10.5	205 (8")
PXA001DARW	<i>Auto Logic 110</i> (Reliant IS2 welded cover)	PXA080W	2030 (80")	860 (34")	7.5	115 (4 ½")
PXA201DARW	<i>Auto Logic 110 Narrow</i> (Reliant IS2 welded cover)	PXA280W	2030 (80")	780 (30")	7.5	115 (4 ½")
PXB001DARW	<i>Auto Logic 200</i> (Reliant IS2 welded cover)	PXB080W	2030 (80")	860 (34")	10.5	205 (8")
PXB201DARW	<i>Auto Logic 200 Narrow</i> (Reliant IS2 welded cover)	PXB280W	2030 (80")	780 (30")	10.5	205 (8")
PXB005DARW	<i>Auto Logic 175</i> (Reliant IS2 welded cover)	PXB180W	2030 (80")	860 (34")	10.5	175 (7")

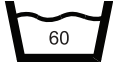
SEAT	
Aura Logic Seat Cushion	PXS001
Length:	470mm (18 ½")
Width:	455mm (17.9")
Height:	50mm (2")
Cell Material	Polyurethane
Sewn Part Number	PXS062
Welded Part Number	PXS062W

COVER SPECIFICATION		
Feature	Standard Cover (Reliant IS²)	Welded Cover (Reliant IS²)
Removable Cover	Yes	Yes
Moisture Vapour Permeable	Low	Low
Low Friction	No	No
Water Resistant / Repellent	Yes	Yes
Polyurethane coating includes an antimicrobial agent to control microbial deterioration of fabric	Yes	Yes
Fire Retardant¹	BS 7175: 0,1 & 5	BS 7175: 0,1 & 5
2-Way Stretch	Yes	Yes
Recommended Wash Temperatures	60°C (140°F) 15 min	60°C (140°F) 15 min.
Maximum Wash Temperatures	Max 95°C (203°F) 15 min.	Max 95°C (203°F) 15 min.
Recommended Drying Temperatures	60°C (140°F) or air dry	60°C (140°F) or air dry
Max Drying Temperatures	Max 80°C (176°F)	Max 80°C (176°F)
Wipedown Chemicals²	Chlorine at strength of 1000ppm or Alcohol at 70% concentration; no phenol; ensure product is dry before storage	Chlorine at strength of 1000ppm or Alcohol at 70% concentration; no phenol; ensure product is dry before storage

1. For additional flammability testing standards, refer to individual product law tags, if applicable
2. Chlorine concentrations may vary from 250ppm to 10,000ppm depending on local policy and contamination status. If an alternative disinfectant is selected from the wide variety available, Arjo recommend that suitability for use is confirmed with the chemical supplier prior to use.

MATTRESS CLEANING SYMBOLS			
	Recommended wash temperature: 15 min at 60°C (140°F) Maximum wash temperature: 15 min at 95°C (203°F)		Tumble dry at 60°C (140°F) Maximum drying temperature: 80°C (176°F)
	Recommended wash temperature: 15 min at 60°C (140°F)		Tumble dry at 60°C (140°F)
	Do not iron		Do Not Use Phenol-based cleaning Solutions
	Wipe surfaces with cleaning solution, then wipe with a cloth moistened with water and dry thoroughly		Use solution diluted to 1000 ppm of Available Chlorine

Electromagnetic Compatibility (EMC)

Product has been tested for compliance with current regulatory standards regarding its capacity to block EMI (electromagnetic interference) from external sources.

Some procedures can help reduce electromagnetic interferences:

- Use only Arjo cables and spare parts to avoid increased emissions or decreased immunity which can compromise the correct functioning of the equipment.
- Ensure that other devices in patient-monitoring and/or life-support areas comply to accepted emissions standards.

WARNING

Wireless communications equipment such as wireless computer network devices, mobile phones, cordless telephones and their base stations, walkie-talkies, etc. Can affect this equipment and should be kept at least 1.5m away from the equipment.

Intended Environment: Home Healthcare Environment and Professional Healthcare facility environment.

Exceptions: HF Surgical Equipment and the RF Shielded room of an ME SYSTEM for magnetic resonance imaging.

WARNING

Use of this equipment adjacent to or stacked with other equipment should be avoided because it could result in improper operation. If such use is necessary, this equipment and the other equipment should be observed to verify that they are operating normally.

Guidance and manufacturer's declaration - electromagnetic emissions		
Emissions Test	Compliance	Electromagnetic environment - guidance
RF emissions CISPR - 11	Group 1	<p>This equipment uses RF energy only for its internal function. Therefore, its RF emissions are very low and are not likely to cause any interference in nearby electronic equipment. This pump is suitable for use in all establishments including domestic and those directly connected to the public low voltage power supply network that supplies buildings used for domestic purposes.</p>
RF emissions CISPR - 11	Class B	
Harmonic emissions IEC 61000-3-2	Class A	
Voltage fluctuations/flicker emissions IEC 61000-3-3	Complies	

Guidance and manufacturer's declaration - electromagnetic immunity			
Immunity Test	IEC 60601-1-2 Test Level	Compliance Level	Electromagnetic environment - guidance
Electrostatic discharge (ESD) EN 61000-4-2	±2kV, ±4kV, ±8kV, ±15kV air ±8kV contact	±2kV, ±4kV, ±8kV, ±15kV air ±8kV contact	Floors should be wood, concrete or ceramic tile. If floors are covered with synthetic material the relative humidity level should be at least 30%.
Conducted disturbances induced by RF fields EN 61000-4-6	3V in 0,15 MHz to 80MHz 6V in ISM and amateur radio bands between 0,15 MHz and 80 MHz 80% AM at 1 kHz	3V in 0,15 MHz to 80MHz 6V in ISM and amateur radio bands between 0,15 MHz and 80 MHz 80% AM at 1 kHz	Portable and mobile RF communications equipment should be used no closer to any part of the product, including cables, than 1.0 m, if the transmitter's output power rating exceeds 1W (a). Field strengths from fixed RF transmitters, as determined by an electromagnetic site survey ^a , should be less than the compliance level in each frequency range. ^b
Radiated RF electromagnetic field IEC 61000-4-3	Home Healthcare environment 10 V/m 80 MHz to 2.7 GHz 80% AM at 1 kHz	Home Healthcare environment 10 V/m 80 MHz to 2.7 GHz 80% AM at 1 kHz	
Electrical transient/burst EN 61000-4-4	±1kV SIP/SOP ports ±2kV AC port 100kHz repetition frequency	±1kV SIP/SOP ports ±2kV AC port 100kHz repetition frequency	Mains power supply should be that of a typical commercial or hospital environment.
Power frequency Magnetic field EN 61000-4-8	30A/m	30A/m	Power frequency magnetic fields should be at levels characteristic of a typical location in a typical commercial or hospital environment.



Guidance and manufacturer's declaration - electromagnetic immunity			
Surge IEC 61000-4-5	±0,5kV ±1kV; ±2 kV, AC Mains, Line to Ground ±0,5kV ±1kV, AC Mains, Line to Line	±0,5kV ±1kV; ±2 kV, AC Mains, Line to Ground ±0,5kV ±1kV, AC Mains, Line to Line	Mains power quality should be that of a typical commercial or hospital environment.
Voltage dips, short interruptions and voltage variations on power supply input lines IEC 61000-4-11	0 % UT; 0,5 cycle At 0°, 45°, 90°, 135°, 180°, 225°, 270° and 315° 0 % UT; 1 cycle and 70 % UT; 25/30 cycles Single phase: at 0° 0 % UT; 250/300 cycle	0 % UT; 0,5 cycle At 0°, 45°, 90°, 135°, 180°, 225°, 270° and 315° 0 % UT; 1 cycle and 70 % UT; 25/30 cycles Single phase: at 0° 0 % UT; 250/300 cycle	Mains power quality should be that of a typical commercial or hospital environment. If the user of the product requires continued operation during power mains interruptions, it is recommended that the product be powered from an uninterrupted power supply or a battery.
NOTE: U_T is the AC mains voltage prior to application of the test level.			
<p>^a Field strengths from fixed transmitters, such as base stations for radio (cellular/cordless) telephones and land mobile radios, amateur radio, AM and FM radio broadcast and TV broadcast cannot be predicted theoretically with accuracy. To assess the electromagnetic environment due to fixed RF transmitters, an electromagnetic site survey should be considered. If the measured field strength in the location in which the product is used exceeds the applicable RF compliance level above, the product should be observed to verify normal operation. If abnormal operation is observed, additional measures may be necessary, such as reorientating or relocating the product.</p> <p>^b Over the frequency range 150 kHz to 80 MHz, field strengths should be less than 3 V/m.</p>			

AUSTRALIA

Arjo Australia Pty Ltd
78, Forsyth Street
O'Connor
AU-6163 Western Australia
Tel: +61 89337 4111
Free: +1 800 072 040
Fax: + 61 89337 9077

BELGIQUE / BELGIË

Arjo NV/SA
Evenbroekveld 16
BE-9420 ERPE-MERE
Tél/Tel: +32 (0) 53 60 73 80
Fax: +32 (0) 53 60 73 81
E-mail: info.belgium@arjo.be

BRASIL

Arjo Brasil Equipamentos Médicos Ltda
Rua Marina Ciufuli Zanfelice, 329 PB02 Galpão
- Lapa
São Paulo – SP – Brasil
CEP: 05040-000
Phone: 55-11-3588-5088
E-mail: vendas.latam@arjo.com
E-mail: servicios.latam@arjo.com

CANADA

Arjo Canada Inc.
90 Matheson Boulevard West
Suite 300
CA-MISSISSAUGA, ON, L5R 3R3
Tel/Tél: +1 905 238 7880
Free: +1 800 665 4831 Institutional
Free: +1 800 868 0441 Home Care
Fax: +1 905 238 7881
E-mail: info.canada@arjo.com

ČESKÁ REPUBLIKA

Arjo Czech Republic s.r.o.
Na Strži 1702/65
140 00 Praha
Czech Republic
Phone No: +420225092307
e-mail: info.cz@arjo.com

DANMARK

Arjo A/S
Vassingerødvej 52
DK-3540 LYNGE
Tel: +45 49 13 84 86
Fax: +45 49 13 84 87
E-mail:
dk_kundeservice@arjo.com

DEUTSCHLAND

Arjo GmbH
Peter-Sander-Strasse 10
DE-55252 MAINZ-KASTEL
Tel: +49 (0) 6134 186 0
Fax: +49 (0) 6134 186 160
E-mail: info-de@arjo.com

ESPAÑA

Arjo Ibérica S.L.
Parque Empresarial Rivas Futura, C/Marie
Curie 5
Edificio Alfa Planta 6 oficina 6.1-.62
ES-28521 Rivas Vacia, MADRID
Tel: +34 93 583 11 20
Fax: +34 93 583 11 22
E-mail: info.es@arjo.com

FRANCE

Arjo SAS
2 Avenue Alcide de Gasperi
CS 70133
FR-59436 RONCQ CEDEX
Tél: +33 (0) 3 20 28 13 13
Fax: +33 (0) 3 20 28 13 14
E-mail: info.france@arjo.com

HONG KONG

Arjo Hong Kong Limited
Room 411-414, 4/F, Manhattan Centre,
8 Kwai Cheong Road, Kwai Chung, N.T.,
HONG KONG
Tel: +852 2960 7600
Fax: +852 2960 1711

ITALIA

Arjo Italia S.p.A.
Via Giacomo Peroni 400-402
IT-00131 ROMA
Tel: +39 (0) 6 87426211
Fax: +39 (0) 6 87426222
E-mail: Italy.promo@arjo.com

MIDDLE EAST

Arjo Middle East FZ-LLC
Office 908, 9th Floor,
HQ Building, North Tower,
Dubai Science Park,
Al Barsha South
P.O Box 11488, Dubai,
United Arab Emirates
Direct +971 487 48053
Fax +971 487 48072
Email: Info.ME@arjo.com

NEDERLAND

Arjo BV
Biezenwei 21
4004 MB TIEL
Postbus 6116
4000 HC TIEL
Tel: +31 (0) 344 64 08 00
Fax: +31 (0) 344 64 08 85
E-mail: info.nl@arjo.com

NEW ZEALAND

Arjo Ltd
34 Vestey Drive
Mount Wellington
NZ-AUCKLAND 1060
Tel: +64 (0) 9 573 5344
Free Call: 0800 000 151
Fax: +64 (0) 9 573 5384
E-mail: nz.info@Arjo.com

NORGE

Arjo Norway AS
Olaf Helsets vei 5
N-0694 OSLO
Tel: +47 22 08 00 50
Faks: +47 22 08 00 51
E-mail: no.kundeservice@arjo.com

ÖSTERREICH

Arjo GmbH
Lemböckgasse 49 / Stiege A / 4.OG
A-1230 Wien
Tel: +43 1 8 66 56
Fax: +43 1 866 56 7000

POLSKA

Arjo Polska Sp. z o.o.
ul. Ks Piotra Wawrzyniaka 2
PL-62-052 KOMORNIKI (Poznań)
Tel: +48 61 662 15 50
Fax: +48 61 662 15 90
E-mail: arjo@arjo.com

PORTUGAL

Arjo em Portugal
MAQUET Portugal, Lda.
(Distributor Exclusivo)
Rua Poeta Bocage n.º 2 - 2G
PT-1600-233 Lisboa
Tel: +351 214 189 815
Fax: +351 214 177 413
E-mail: Portugal@arjo.com

SUISSE / SCHWEIZ

Arjo AG
Fabrikstrasse 8
Postfach
CH-4614 HÄGENDORF
Tél/Tel: +41 (0) 61 337 97 77
Fax: +41 (0) 61 311 97 42

SUOMI

Arjo Scandinavia AB
Riihitontuntie 7 C
02200 Espoo
Finland
Puh: +358 9 6824 1260
E-mail: Asiakaspalvelu.finland@arjo.com

SVERIGE

Arjo International HQ
Hans Michelsensgatan 10
SE-211 20 MALMÖ
Tel: +46 (0) 10 494 7760
Fax: +46 (0) 10 494 7761
E-mail: kundservice@arjo.com

UNITED KINGDOM

Arjo UK and Ireland
Houghton Hall Park
Houghton Regis
UK-DUNSTABLE LU5 5XF
Tel: +44 (0) 1582 745 700
Fax: +44 (0) 1582 745 745
E-mail: sales.admin@arjo.com

USA

Arjo Inc.
2349 W Lake Street Suite 250
US-Addison, IL 60101
Tel: +1 630 307 2756
Free: +1 800 323 1245 Institutional
Free: +1 800 868 0441 Home Care
Fax: +1 630 307 6195
E-mail: us.info@arjo.com

JAPAN

Arjo Japan K.K.
東京都港区虎ノ門三丁目7番8号 ランディック
第2虎ノ門ビル9階
電話: +81 (0)3-6435-6401

At Arjo, we are committed to improving the everyday lives of people affected by reduced mobility and age-related health challenges. With products and solutions that ensure ergonomic patient handling, personal hygiene, disinfection, diagnostics, and the effective prevention of pressure ulcers and venous thromboembolism, we help professionals across care environments to continually raise the standard of safe and dignified care. Everything we do, we do with people in mind.



ArjoHuntleigh AB
Hans Michelsensgatan 10
211 20 Malmö, Sweden
www.arjo.com

arjo



CE
2797