

INSTRUCTIONS FOR USE

Aura



WARNING

To avoid injury, always read this Instructions for Use and accompanied documents before using the product.



Mandatory to read the Instructions for Use

Design Policy and Copyright

® and ™ are trademarks belonging to the Arjo group of companies.

© Arjo 2019.

As our policy is one of continuous improvement, we reserve the right to modify designs without prior notice. The content of this publication may not be copied either whole or in part without the consent of Arjo.

Contents

General Safety	iii
Introduction	1
About this Manual	1
Intended use	1
About Aura	1
Clinical Applications	3
Indications	3
Contraindications	3
Cautions	3
Care of the patient when sitting	3
Installation	4
Preparing the Aura Cushion and Pump	4
Controls, Indicators and Alarms	6
Controls	6
Indicators	6
Alarms	6
Self Test	6
Operation	7
Installing the System	7
Inflating the Seat Cushion	7
Pressure Control	8
Stopping Operation	8
Deflating the Seat Cushion	8
Decontamination	9
Troubleshooting Guide	10
Technical Specification	11
Pump	11
Seat	12
Cover Specification	13
Electromagnetic Compatibility (EMC)	14

GENERAL SAFETY

Before you connect the system pump to a mains socket, read carefully all the installation instructions contained within this manual.

The system has been designed to comply with regulatory safety standards including:

- EN60601-1:2006/A1:2013 and IEC 60601-1:2005/A1:2012.
- EN60601-1-11:2010; IEC 60601-1-11:2010 and IEC60601-1-8:2012.
- NSI/AAMI ES 60601-1(2005)+AMD(2012)and CAN/CSA-C22.2 No.60601-1 (2008)+(2014).

Safety Warnings

- **It is the responsibility of the care giver to ensure that the user can use this product safely.**
- **Make sure that the mains power cable and tubeset or air hoses are positioned to avoid causing a trip or other hazard or other possible entrapment areas.**
- **Electrical equipment may be hazardous if misused. There are no user-serviceable parts inside the pump. The pump case must only be removed by authorised technical personnel. No modification of this equipment is allowed.**
- **The power switch must be accessible at all times. Use the power switch to disconnect the pump completely from the electricity supply.**
- **Disconnect the pump from the mains power socket before cleaning and inspecting.**
- **Keep the pump away from sources of liquids and do not immerse in water.**
- **Do not use the pump in the presence of uncontained flammable liquids or gasses.**
- **The cover of this product is vapour permeable but not air permeable and may present a suffocation risk.**
- **Bags supplied with this equipment may present a suffocation risk; to avoid the risk of suffocation keep the bags away from babies and small children.**
- **There is no transport mode on the Aura[®] seat cushion.**
- **Only the pump and seat combination as indicated by Arjo should be used. The correct function of the product cannot be guaranteed if incorrect pump and cushion combinations are used.**
- **If a serious incident occurs in relation to this medical device, affecting the user, or the patient then the user or patient should report the serious incident to the medical device manufacturer or the distributor. In the European Union, the user should also report the serious incident to the Competent Authority in the member state where they are located.**

Precautions

For your own safety and the safety of the equipment, always take the following precautions:

- Placing extra layers between the patient and the seat potentially reduces the benefits provided by the seat and should be avoided or kept to a minimum. As part of sensible pressure area care, it is advisable to avoid wearing clothing which may cause areas of localised high pressure due to creases, seams, etc. Placing objects in pockets should be avoided for the same reason.
- Do not expose the system, especially the seat, to naked flames, such as cigarettes, etc. In the event of a fire, a leak in the seat could propagate the fire.
- Do not store the system in direct sunlight.
- Do not use phenol-based solutions to clean the system.
- Make sure the system is clean and dry prior to use or storage.
- Never use sharp objects or electrically heated under blankets on or under the system.
- Store the pump and seat in the protective bags supplied.

There should always be an operator monitoring the system in case there is a system alarm.

Electromagnetic Compatibility (EMC)

This product complies with the requirements of applicable EMC Standards. Medical electrical equipment needs special precautions regarding EMC and needs to be installed in accordance with the following instructions:

- The use of accessories not specified by the manufacturer may result in increased emissions by, or decreased immunity of, the equipment, affecting its performance.
- Portable and mobile radio frequency (RF) communications equipment (e.g. mobile/cell phones) can affect medical electrical equipment.
- If this equipment needs to be used adjacent to other electrical equipment, normal operation must be checked before use.
- For detailed EMC information contact Arjo service personnel.

Environmental Protection

Incorrect disposal of this equipment and its component parts, particularly batteries or other electrical components, may produce substances that are hazardous to the environment. To minimise these hazards, contact Arjo for information on correct disposal.

Expected Service Life

The *Aura* pump has an expected service life of seven years. To maintain the condition of the pump, have the pump serviced regularly according to the schedule recommended by Arjo.

Do NOT use unapproved accessories or attempt to modify, disassemble or otherwise misuse the *Aura* system. Failure to observe this caution could result in injury, or in extreme cases, death.

End of Life Disposal

- Fabric material used on the mattresses or any other textiles, polymers or plastic materials etc. should be sorted as combustible waste.
- Mattresses at the end of life should be disposed of as waste according to the national or local requirements which may be landfill or combustion.
- Pump units have electrical and electronic components should be disassembled and recycled per Waste of Electrical and Electronic Equipment (WEEE) or in accordance with local or national regulation.

1. Introduction

About this Manual This manual is your introduction to the *Aura* system. You must read and fully understand this manual before using the system.

Use this manual to initially set up the system, and keep it as a reference for day-to-day routines and as a guide to maintenance.

If you have any difficulties in setting-up or using the *Aura* system, contact your Arjo sales office, listed at the end of this manual.

Intended use The intended use of this product is to prevent and/or manage pressure ulcers for patients up to 120 kg (264 lb).

The *Aura* system should be used as part of a prescribed plan of care (refer to “Indications” on page 3).

About *Aura* The *Aura* system consists of a pump and a seat cushion and can be used on standard hospital chairs.

The *Aura* system can be used in acute care, long-term care and home care environments, including private homes.

A full technical description of the *Aura* system can be found in the Service Manual, part numbers SER0004 (pump) and SER0005 (seat cushion), available from your Arjo sales office.

Aura Pump

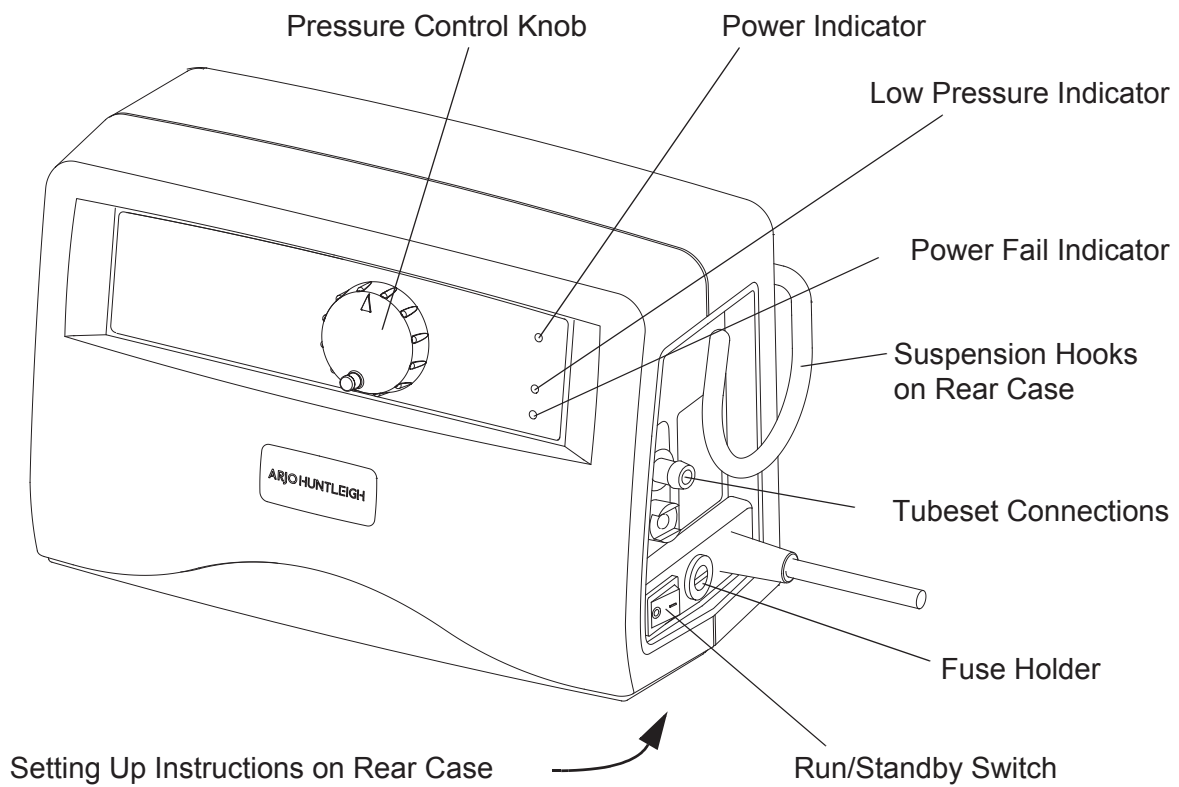

Aura Seat Cushion

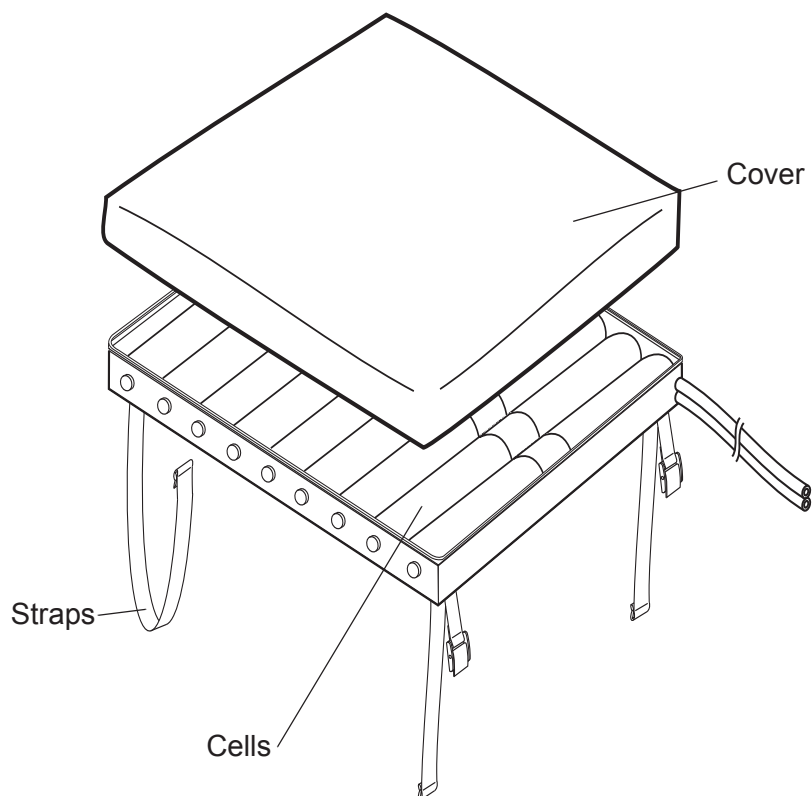

2. Clinical Applications

Indications The *Aura* systems are indicated for the prevention and/or management of all categories¹ of pressure ulcer, when combined with an individualised, comprehensive pressure ulcer protocol: for example, repositioning, nutritional support, skin care. Selection should be based upon a holistic assessment of the patient's individual care needs.

These systems represent one aspect of a pressure ulcer management protocol; all other aspects of care should be considered by the prescribing clinician.

If existing wounds do not improve or the patient's condition changes the overall therapy regimen should be reviewed by the prescribing clinician.

The above are guidelines only and should not replace clinical judgement.

The *Aura* cushion is designed for patients weighing up to 120 kg (264 lb).

Contraindications Do not use *Aura* systems for patients with unstable spinal fractures.

Cautions If patients have other unstable fractures, or conditions which may be complicated by a soft or moving surface, advice should be sought from an appropriate clinician before use.

While the *Aura* systems have been designed to manage patients up to the weight limits indicated above, those approaching this upper limit are likely to have additional care and mobility needs and may be better suited to a specialist bariatric system.

Active therapy (alternating) cushions may be unsuitable for patients with poor sitting posture or pelvic deformity; advice from a seating specialist should be sought.

Care of the patient when sitting Seated patients are at increased risk of pressure ulcers particularly if they are immobile or have wounds over the seating area. For optimal outcome, provide a pressure redistributing seat cushion in a chair which promotes a good sitting posture and has a level base seat to support the cushion, in addition to an individualised repositioning programme.

1. NPUAP/EPUAP International Pressure Ulcer Guideline, 2014.

3. Installation

WARNING

Bags supplied with this equipment may present a suffocation risk; to avoid the risk of suffocation keep the bags away from babies and small children.

The system is simple to set up and the following guidelines may assist you.

Preparing the *Aura* Cushion and Pump

1. Remove the contents of the packaging. You should have the following items:
 - *Aura* pump with integral mains power cord and hanging bracket.
 - *Aura* seat cushion, with cover
2. Plug the pump power cable into wall socket. Do NOT switch the pump on.
3. The pump should be placed feet down on any convenient horizontal surface or alternatively suspended from the chair frame by means of the spring loaded hanging hooks.
4. Check that there are no sharp objects on the chair surface which may puncture the seat cushion.
5. Place the *Aura* cushion on top of the chair surface. From a standing position in front of the chair and facing it, ensure that:
 - the air feed tubes appear from the front right corner of the cushion
 - the cells are uppermost
 - the cells are in a horizontal position across the chair, NOT from front to back.

Cautions

- **Do not use the *Aura* seat cushion without a foam cushion beneath it.**
- **Always use the *Aura* seat cushion with the protective top cover.**
- **Always use the *Aura* seat cushion in the correct orientation.**
- **Avoid trailing cables - ensure that cables and tubing are positioned beneath the chair to avoid causing a hazard.**

6. Secure the *Aura* cushion to the chair by using the fixing straps as shown in the following illustrations.
7. If the chair is of the open sided construction, then fix the cushion as shown below.

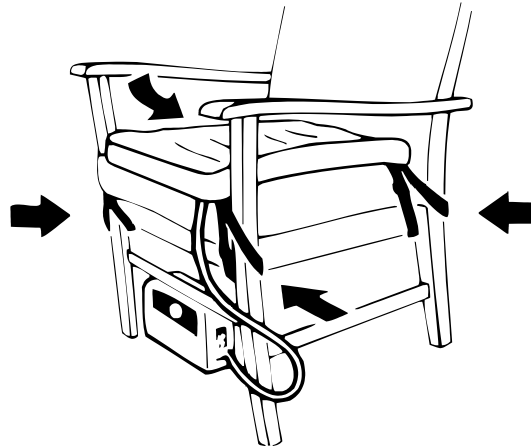

8. If the chair is of the closed side type with a removable seat cushion, fix the *Aura* cushion as shown below.

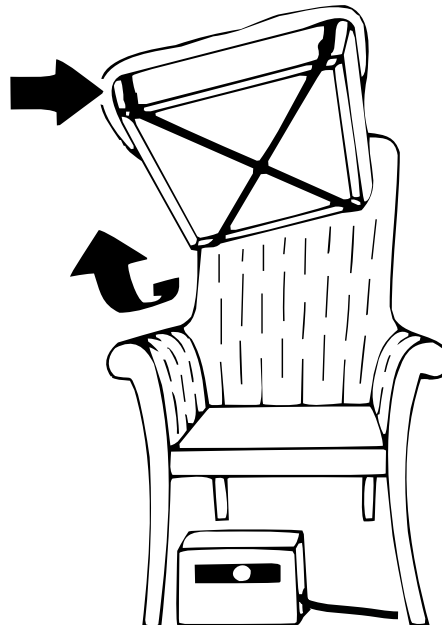

9. If the chair is of the closed side type with a non-removable seat cushion, then security will rely on the anti-slip pads on the base of the *Aura* cushion.
10. Place the protective cover over the cushion and zip up all round, taking care not to trap any material in the zip.
11. Connect the air feed tube connectors to the air outlet connectors on the pump unit, ensuring that the tubes are not “kinked” or twisted. Push the connectors in until they click.

4. Controls, Indicators and Alarms

Controls

Run/Standby Switch

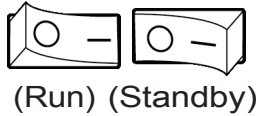

This is situated on the side panel of the pump and is used to activate the unit and reset the alarm. Mains isolation should be performed by switching the pump to standby (O) and then removing the mains plug from the socket.

Pressure Control

This is situated on the front panel and is adjusted by the user to provide extra comfort.

Indicators

Run/Standby



A green light on the front panel indicates that the pump is running.

Low Pressure



In the event of low pressure in the seat cushion, the yellow Low Pressure alarm indicator illuminates and an audible alarm sounds.

Power Fail



In the event of a mains failure, the yellow alarm indicator illuminates and an audible alarm sounds. If the power supply is returned, the audible alarm stops, but the alarm light remains illuminated until the system is reset.

Alarms

Alarm Priority

In compliance with 60601-1-8, all the alarm conditions are low priority.

Alarm Reset

When the cause of the alarm has been resolved, the pump must be reset. This can be achieved by switching the pump to Standby and back to Run using the Run/Standby switch on the side panel.

Self Test

Every time the pump is switched on, all indicator lights illuminate for approximately two seconds. During this period, the system self tests its circuits.

5. Operation

These instructions cover day-to-day operation of the system. Other operations, such as maintenance and repair, should only be carried out by suitably qualified personnel.

NOTE

Refer to Section 4, Page 6 “Controls, Indicators and Alarms” for a comprehensive description of the controls and indicators on the pump.

NOTE

If the operation of the pump changes during use, refer to Troubleshooting procedures on page 10 of this manual before calling a service engineer or contacting your local Arjo sales office.

Installing the System Before using the *Aura* system make sure that it has been installed correctly in accordance with Section 3, Page 4 “Installation”.

WARNING

Make sure that the mains power cable and seat cushion tubeset are positioned to avoid causing a trip or strangulation hazard, and are clear of any possible entrapment areas.

Do not place the patient on the seat cushion until it is fully inflated

**Inflating the
Seat Cushion**

1. Connect the pump to the mains power supply using the supplied cable and set the Run/Standby switch to Run (|).

NOTE

It may take up to two minutes to inflate the cushion.

2. When the seat cushion is inflated, the patient can sit on the seat cushion.

Pressure Control

Adjust the Pressure Control to the patient's requirements.

To Adjust the Pressure Control Knob Position

The pressure control knob (2) is locked in position to prevent accidental rotation.

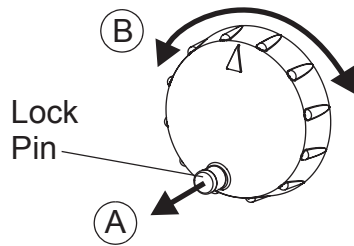

To adjust the position of the pressure control knob:

1. Lift the lock pin (A) to release the control knob.
2. Rotate the control knob (B) whilst the lock pin is raised.
3. Release the lock pin when the pressure control knob is in the desired position to lock the control knob.

NOTE

Rotate the pressure control knob clockwise to increase and counter-clockwise to decrease pressure.

NOTE

There is no transport mode on the Aura seat cushion.

Stopping Operation

To stop the pump operating, switch the pump to the Standby (O) position.

To completely isolate the pump from the mains, remove the plug from the mains power socket.

Deflating the Seat Cushion

To deflate and store the seat cushion, do the following:

1. Switch the pump to the Standby (O) position, and disconnect the pump from the mains power supply.
2. Remove the tubeset from the pump.
3. Deflate the seat cushion.

NOTE

Make sure the seat cushion is dry before rolling it up.

6. Decontamination

The following processes are recommended, but should be adapted to comply with the local or national guidelines (Decontamination of Medical Devices) which may apply within the Healthcare Facility or the country of use. If you are uncertain, you should seek advice from your local Infection Control Specialist.

The *Aura* system should be routinely decontaminated between patients and at regular intervals while in use; as is good practice for all reusable medical devices.

WARNING

Remove the electrical supply to the pump by disconnecting the mains power cord from the mains power supply before cleaning.
Protective clothing should always be worn when carrying out decontamination procedures.

Caution

Do not use Phenol-based solutions or abrasive compounds or pads during the decontamination process as these will damage the surface coating. Do not boil or autoclave the cover.
Avoid immersing electrical parts in water during the cleaning process. Do not spray cleaning solutions directly onto the pump.

To clean Clean all exposed surfaces and remove any organic debris by wiping with a cloth moistened with a simple (neutral) detergent and water. Dry thoroughly.

Do not allow water or cleaning solutions to collect on the surface of the pump.

Chemical Disinfection To protect the integrity of the cover we recommend a chlorine-releasing agent, such as sodium hypochlorite, at a strength of 1,000ppm available chlorine (this may vary from 250ppm to 10,000ppm depending on local policy and contamination status).

Wipe all cleaned surfaces with the solution, then wipe with a cloth moistened in water and dry thoroughly.

Alcohol based disinfectants (strength 70%) may be used as an alternative.

Ensure the product is dry before storage.

If an alternative disinfectant is selected from the wide variety available we recommend that suitability for use is confirmed with the chemical supplier prior to use.

DO NOT WRING/MANGLE, AUTOCLAVE OR USE PHENOLIC BASED SOLUTIONS.

Thermal Disinfection For information for the seat top cover, including laundering guidelines, refer to "CUSHION CLEANING SYMBOLS" on page 13.

Re-use with multiple patients Professional hygiene maintenance is required before re-use of the system with a different patient.

7. Troubleshooting Guide

Problem	Possible Cause	Action
Seat cushion not inflating.	<ol style="list-style-type: none"> 1. Tubes kinked. 2. Pump not switched on. 3. No pump output. 4. Punctured cell or leakage from T-connector 5. Tubes not correctly fitted. 	<p>Check</p> <p>Check</p> <p>Check</p> <p>Check. See Pump not operating below</p> <p>Check</p>
Consistent Low Pressure Alarm.	<ol style="list-style-type: none"> 1. Tubes not correctly fitted. 2. Leakage. 	<p>Check</p> <p>Check</p>
The Power Fail indicators (audible and visual) are active.	<ol style="list-style-type: none"> 1. A mains power failure has occurred. 2. The power cord has been removed from the wall socket. 	<p>Check</p> <p>Check</p>
The Power Fail indicator remains constantly illuminated but there is no audible alarm.	There has been a mains power failure but power has been restored.	Check if electrical plug is correctly fitted, and if pump is running correctly.
Pump makes a lot of noise and/or is causing a lot of vibration.	System damaged or dirty.	Call Service Engineer for maintenance.
Pump not operating.	<ol style="list-style-type: none"> 1. Pump Run switch not on. 2. Plug not inserted correctly. 3. Fuse blown. 4. Technical failure. 	<p>Switch on</p> <p>Check</p> <p>Call Service Engineer for maintenance.</p> <p>Call Service Engineer for maintenance.</p>
All indicators remain illuminated on initial switch-on.	Internal fault.	Call Service Engineer for maintenance.

NOTE

Ensure pump alarms are reset by operating the Run/Standby switch after the fault has been corrected.

NOTE













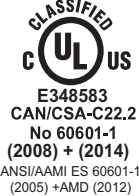

If the operation or performance of the pump is not restored by performing the troubleshooting procedures, stop using the system immediately and call the service engineer.

8. Technical Specification

PUMP			
Model:	Aura		
			KSA
Supply Voltage:	230 V	120 V	230 V
Supply Frequency:	50 Hz	60 Hz	60 Hz
Power Input:	14 VA	14 VA	14 VA
Size:	248 x 160 x 116 mm (9.8 x 6.3 x 4.6 in.)		
Weight:	2.75 kg (6 lb)		
Case Material:	ABS Plastic		
Plug Fuse Rating:	5A to BS1362 (UK ONLY)		
Pump Fuse Rating:	T1AL 250 V		
Degree of protection against electric shock:	Mains Connected - Class II, Double Insulated with Functional Earth. Type BF		
Degree of protection against liquid ingress:	IP21 - Protection against ingress of solid objects more than 12.5mm diameter and water droplets falling vertically.		
Mode of operation:	10 minute Operating Cycle		
Pressure Range:	70 - 100 mmHg \pm 5%		

ENVIRONMENTAL INFORMATION			
Condition	Temperature Range	Relative Humidity	Atmospheric Pressure
Operating	+10°C to +40°C (+50°F to +104°F)	30% to 75% (non-condensing)	700hPa to 1060 hPa
Storage (Long Term)	+10°C to +40°C (+50°F to +104°F)	20% to 95% (non-condensing)	700 hPa to 1060 hPa
Storage (Short Term)	-20°C to +65°C (-4°F to 149°F)	20% to 95% (non-condensing)	500 hPa to 1060 hPa
NOTE <i>If the pump is stored in conditions outside the "Operating" ranges, allow time for its temperature to stabilise to normal before use.</i>			
NOTE <i>One of the effects of prolonged exposure to high temperatures is to increase the self-discharge of the internal battery; this will reduce the duration of power fail alarms. The pump will fully charge the battery over a 24-hour period when the pump is connected to a mains power supply.</i>			

Pump Symbols







	The operator must read this document (Instructions for Use) before use. Note: This symbol is blue on the product label.		Refer to this document (Instructions for Use) for a description of the product classification (3rd Edition).
	With respect to electric shock, fire and mechanical hazards only in accordance with CAN/CSA-C22.2 No.60601-1 (2008)+(2014) ANSI/AAMI ES 60601-1		CE marking indicating conformity with European Community harmonised legislation Figures indicate Notified Body supervision.
	Refer to this document (Instructions for Use) for a description of the product classification (2nd Edition).		Indicates the product is a Medical Device according to EU Medical Device Regulation 2017/745.
	Manufacturer: This symbol is accompanied by the name and the address of the manufacturer.		Double Insulated
	Do not dispose of in domestic refuse		Serial Number
	Type BF		Model number
	Power: disconnect		Power: connect

SEAT

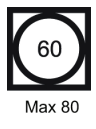
Aura Seat Cushion	403001UN
Length:	455 mm (17.9 in.)
Width:	470 mm (18.5 in.)
Height:	50 mm (2.0 in.) minimum
Cell Material:	Polyurethane
Weight:	0.7 kg (1.5 lb)
Sewn Part Number	403050
Welded Part Number	403050W

COVER SPECIFICATION	
Feature	Standard Cover (Reliant IS ²)
Removable Cover	Yes
Moisture Vapour Permeable	Low
Low Friction	No
Water Resistant / Repellent	Yes
Polyurethane coating includes an antimicrobial agent to control microbial deterioration of fabric	Yes
Fire Retardant ^a	BS 7175: 0,1 & 5
2-Way Stretch	Yes
Recommended Wash Temperatures	60°C (140°F) 15 min.
Maximum Wash Temperatures	Max 95°C (203°F) 15 min.
Recommended Drying Temperatures	60°C (140°F) or air dry
Max Drying Temperatures	Max 80°C (176°F)
Wipedown Chemicals ^b	Chlorine at strength of 1000ppm or Alcohol at 70% concentration; no phenol; ensure product is dry before storage

- a. For additional flammability testing standards, refer to individual product law tags, if applicable
- b. Chlorine concentrations may vary from 250ppm to 10,000ppm depending on local policy and contamination status. If an alternative disinfectant is selected from the wide variety available, Arjo recommend that suitability for use is confirmed with the chemical supplier prior to use.

CUSHION CLEANING SYMBOLS			
	Recommended wash temperature: 15 min at 60°C (140°F) Maximum wash temperature: 15 min at 95°C (203°F)		Tumble dry at 60°C (140°F) Maximum drying temperature: 80°C (176°F)
	Recommended wash temperature: 15 min at 60°C (140°F)		Tumble dry at 60°C (140°F)
	Do not iron		Do Not Use Phenol-based cleaning Solutions
	Wipe surfaces with cleaning solution, then wipe with a cloth moistened with water and dry thoroughly		Use solution diluted to 1000 ppm of Available Chlorine

9. Electromagnetic Compatibility (EMC)

Product has been tested for compliance with current regulatory standards regarding its capacity to block EMI (electromagnetic interference) from external sources.

Some procedures can help reduce electromagnetic interferences:

- Use only Arjo cables and spare parts to avoid increased emissions or decreased immunity which can compromise the correct functioning of the equipment.
- Ensure that other devices in patient-monitoring and/or life-support areas comply to accepted emissions standards.

WARNING

Wireless communications equipment such as wireless computer network devices, mobile phones, cordless telephones and their base stations, walkie-talkies, etc. can affect this equipment and should be kept at least 1.5m away from the equipment.

Intended Environment: Home Healthcare Environment and Professional Healthcare facility environment.

Exceptions: HF Surgical Equipment and the RF Shielded room of an ME SYSTEM for magnetic resonance imaging

WARNING

Use of this equipment adjacent to or stacked with other equipment should be avoided because it could result in improper operation. If such use is necessary, this equipment and the other equipment should be observed to verify that they are operating normally.

Guidance and manufacturer's declaration – electromagnetic emission		
Emission test	Compliance	Guidance
RF emissions CISPR 11	Group 1	This equipment uses RF energy only for its internal functions. Therefore its RF emissions are very low and are not likely to cause any interference in nearby electronic equipment. This equipment is suitable for use in all establishments, including domestic establishments and those directly connected to the public low voltage power supply network that supplies buildings used for domestic purposes.
RF emissions CISPR 11	Class B	
Harmonic emissions IEC 61000-3-2	Class A	
Voltage fluctuations/ flicker emissions IEC61000-3-3	Complies	

Guidance and manufacturer's declaration – electromagnetic immunity			
Immunity test	IEC 60601-1-2 test level	Compliance level	Electromagnetic environment – guidance
Electrostatic discharge (ESD) EN 61000-4-2	±2kV, ±4kV, ±8kV, ±15kV air ±8kV contact	±2kV, ±4kV, ±8kV, ±15kV air ±8kV contact	Floors should be wood, concrete or ceramic tile. If floors are covered with synthetic material the relative humidity level should be at least 30%
Conducted disturbances induced by RF fields EN 61000-4-6	3V in 0,15 MHz to 80 MHz 6V in ISM and amateur radio bands between 0,15 MHz and 80 MHz 80% AM at 1 kHz	3V in 0,15 MHz to 80 MHz 6V in ISM and amateur radio bands between 0,15 MHz and 80 MHz 80% AM at 1 kHz	Portable and mobile RF communications equipment should be used no closer to any part of the product, including cables, than 1.0m, if the transmitter's output power rating exceeds 1W ^a Field strengths from fixed RF transmitters, as determined by an electromagnetic site survey, should be less than the compliance level in each frequency range ^b Interference may occur in the vicinity of equipment marked with this symbol: 
Radiated RF electromagnetic field EN 61000-4-3	Home Healthcare environment 10 V/m 80 MHz to 2,7 GHz 80% AM at 1 kHz	Home Healthcare environment 10 V/m 80 MHz to 2,7 GHz 80% AM at 1 kHz	
Electrical fast transient/burst EN 61000-4-4	±1kV SIP/SOP ports ±2kV AC port 100 kHz repetition frequency	±1kV SIP/SOP ports ±2kV AC port 100kHz repetition frequency	Mains power supply should be that of a typical commercial or hospital environment.
Power frequency Magnetic field EN 61000-4-8	30 A/m	30 A/m	Power frequency magnetic fields should be at levels characteristic of a typical location in a typical commercial or hospital environment.

Guidance and manufacturer's declaration – electromagnetic immunity			
Immunity test	IEC 60601-1-2 test level	Compliance level	Electromagnetic environment – guidance
Surge IEC61000-4-5	$\pm 0.5\text{kV}, \pm 1\text{kV}, \pm 2\text{kV}$, AC Mains Line to Ground $\pm 0.5\text{kV}, \pm 1\text{kV}$, AC Mains Line to Line	$\pm 0.5\text{kV}, \pm 1\text{kV}, \pm 2\text{kV}$, AC Mains Line to Ground $\pm 0.5\text{kV}, \pm 1\text{kV}$, AC Mains Line to Line	Mains power quality should be that of a typical commercial or hospital environment.
Voltage dips, short interruptions and voltage variations on power supply input lines IEC 61000-4-11	0% U_T ; 0,5 cycle At 0°, 45°, 90°, 135°, 180°, 225°, 270° and 315° 0% U_T ; 1 cycle and 70% U_T ; 25/30 cycles Single phase: at 0° 0% U_T ; 250/300 cycle	0% U_T ; 0,5 cycle At 0°, 45°, 90°, 135°, 180°, 225°, 270° and 315° 0% U_T ; 1 cycle and 70% U_T ; 25/30 cycles Single phase: at 0° 0% U_T ; 250/300 cycle	Mains power quality should be that of a typical commercial or hospital environment. If the user of the pump requires continued operation during power mains interruption, it is recommended that the pump be powered from an uninterruptible power supply or battery.
NOTE: U_T is the AC mains voltage prior to application of the test level.			
<p>^a Field strengths from fixed transmitters, such as base stations for radio (cellular/cordless) telephones and land mobile radios, amateur radio, AM and FM radio broadcast and TV broadcast cannot be predicted theoretically with accuracy. To assess the electromagnetic environment due to fixed RF transmitters, an electromagnetic site survey should be considered. If the measured field strength in the location in which the product is used exceeds the applicable RF compliance level above, the product should be observed to verify normal operation. If abnormal performance is observed, additional measures may be necessary.</p> <p>^b Over the frequency range 150 kHz to 80 MHz, field strengths should be less than 1 V/m.</p>			

Intentionally left blank

AUSTRALIA

Arjo Australia Pty Ltd
78, Forsyth Street
O'Connor
AU-6163 Western Australia
Tel: +61 89337 4111
Free: +1 800 072 040
Fax: + 61 89337 9077

BELGIQUE / BELGIË

Arjo NV/SA
Evenbroekveld 16
BE-9420 ERPE-MERE
Tél/Tel: +32 (0) 53 60 73 80
Fax: +32 (0) 53 60 73 81
E-mail: info.belgium@arjo.com

BRASIL

Arjo Brasil Equipamentos Médicos Ltda
Rua Marina Ciufuli Zanfelice, 329 PB02 Galpão
- Lapa
São Paulo – SP – Brasil
CEP: 05040-000
Phone: 55-11-3588-5088
E-mail: vendas.latam@arjo.com
E-mail: servicios.latam@arjo.com

CANADA

Arjo Canada Inc.
90 Matheson Boulevard West
Suite 300
CA-MISSISSAUGA, ON, L5R 3R3
Tel/Tél: +1 905 238 7880
Free: +1 800 665 4831 Institutional
Free: +1 800 868 0441 Home Care
Fax: +1 905 238 7881
E-mail: info.canada@arjo.com

ČESKÁ REPUBLIKA

Arjo Czech Republic s.r.o.
Na Strži 1702/65
140 00 Praha
Czech Republic
Phone No: +420225092307
e-mail: info.cz@arjo.com

DANMARK

Arjo A/S
Vassingerødvej 52
DK-3540 LYNGE
Tel: +45 49 13 84 86
Fax: +45 49 13 84 87
E-mail:
dk_kundeservice@arjo.com

DEUTSCHLAND

Arjo GmbH
Peter-Sander-Strasse 10
DE-55252 MAINZ-KASTEL
Tel: +49 (0) 6134 186 0
Fax: +49 (0) 6134 186 160
E-mail: info-de@arjo.com

ESPAÑA

Arjo Ibérica S.L.
Parque Empresarial Rivas Futura, C/Marie
Curie 5
Edificio Alfa Planta 6 oficina 6.1-.62
ES-28521 Rivas Vacia, MADRID
Tel: +34 93 583 11 20
Fax: +34 93 583 11 22
E-mail: info.es@arjo.com

FRANCE

Arjo SAS
2 Avenue Alcide de Gasperi
CS 70133
FR-59436 RONCQ CEDEX
Tél: +33 (0) 3 20 28 13 13
Fax: +33 (0) 3 20 28 13 14
E-mail: info.france@arjo.com

HONG KONG

Arjo Hong Kong Limited
Room 411-414, 4/F, Manhattan Centre,
8 Kwai Cheong Road, Kwai Chung, N.T.,
HONG KONG
Tel: +852 2960 7600
Fax: +852 2960 1711

ITALIA

Arjo Italia S.p.A.
Via Giacomo Peroni 400-402
IT-00131 ROMA
Tel: +39 (0) 6 87426211
Fax: +39 (0) 6 87426222
E-mail: Italy.promo@arjo.com

MIDDLE EAST

Arjo Middle East FZ-LLC
Office 908, 9th Floor,
HQ Building, North Tower,
Dubai Science Park,
Al Barsha South
P.O Box 11488, Dubai,
United Arab Emirates
Direct +971 487 48053
Fax +971 487 48072
Email: Info.ME@arjo.com

NEDERLAND

Arjo BV
Biezenwei 21
4004 MB TIEL
Postbus 6116
4000 HC TIEL
Tel: +31 (0) 344 64 08 00
Fax: +31 (0) 344 64 08 85
E-mail: info.nl@arjo.com

NEW ZEALAND

Arjo Ltd
34 Vestey Drive
Mount Wellington
NZ-AUCKLAND 1060
Tel: +64 (0) 9 573 5344
Free Call: 0800 000 151
Fax: +64 (0) 9 573 5384
E-mail: nz.info@Arjo.com

NORGE

Arjo Norway AS
Olaf Helset's vei 5
N-0694 OSLO
Tel: +47 22 08 00 50
Faks: +47 22 08 00 51
E-mail: no.kundeservice@arjo.com

ÖSTERREICH

Arjo GmbH
Lemböckgasse 49 / Stiege A / 4.OG
A-1230 Wien
Tel: +43 1 8 66 56
Fax: +43 1 866 56 7000

POLSKA

Arjo Polska Sp. z o.o.
ul. Ks Piotra Wawrzyniaka 2
PL-62-052 KOMORNIKI (Poznań)
Tel: +48 61 662 15 50
Fax: +48 61 662 15 90
E-mail: arjo@arjo.com

PORTUGAL

Arjo em Portugal
MAQUET Portugal, Lda.
(Distribuidor Exclusivo)
Rua Poeta Bocage n.º 2 - 2G
PT-1600-233 Lisboa
Tel: +351 214 189 815
Fax: +351 214 177 413
E-mail: Portugal@arjo.com

SUISSE / SCHWEIZ

Arjo AG
Fabrikstrasse 8
Postfach
CH-4614 HÄGENDORF
Tél/Tel: +41 (0) 61 337 97 77
Fax: +41 (0) 61 311 97 42

SUOMI

Arjo Scandinavia AB
Riihitontuntie 7 C
02200 Espoo
Finland
Puh: +358 9 6824 1260
E-mail: Asiakaspalvelu.finland@arjo.com

SVERIGE

Arjo International HQ
Hans Michelsensgatan 10
SE-211 20 MALMÖ
Tel: +46 (0) 10 494 7760
Fax: +46 (0) 10 494 7761
E-mail: kundservice@arjo.com

UNITED KINGDOM

Arjo UK and Ireland
Houghton Hall Park
Houghton Regis
UK-DUNSTABLE LU5 5XF
Tel: +44 (0) 1582 745 700
Fax: +44 (0) 1582 745 745
E-mail: sales.admin@arjo.com

USA

Arjo Inc.
2349 W Lake Street Suite 250
US-Addison, IL 60101
Tel: +1 630 307 2756
Free: +1 800 323 1245 Institutional
Free: +1 800 868 0441 Home Care
Fax: +1 630 307 6195
E-mail: us.info@arjo.com

JAPAN

Arjo Japan K.K.
東京都港区虎ノ門三丁目7番8号 ランディッ
ク第2虎ノ門ビル9階
電話 : +81 (0)3-6435-6401

Address page - REV 24: 04/2019

At Arjo, we are committed to improving the everyday lives of people affected by reduced mobility and age-related health challenges. With products and solutions that ensure ergonomic patient handling, personal hygiene, disinfection, diagnostics, and the effective prevention of pressure ulcers and venous thromboembolism, we help professionals across care environments to continually raise the standard of safe and dignified care. Everything we do, we do with people in mind.



ArjoHuntleigh AB
Hans Michelsensgatan 10
211 20 Malmö, Sweden
www.arjo.com

arjo



500935EN

CE
2797