

Enterprise 5000X (E5X)



This Quick Reference Guide (QRG) is intended to assist the user in understanding the basic functions of this medical bed. The QRG does not replace the safety warnings, cautions and other important information provided in the Instructions for Use (IFU) supplied with the equipment; copies of the IFU are available on request from Arjo.

Some of the functions should only be used by clinically-qualified personnel. The carer should make sure they have read and understood the IFU before using this medical bed.

A clinically-qualified person should assess the age, height and medical condition of the patient to ensure they can use the product safely.

Place the mattress platform in the low height position when the patient is unattended.

Product overview



- | | | |
|---------------------------------|--------------------------------|-----------------------|
| ① Head board | ⑦ Bed extension locking handle | ⑬ Drainage bag rail |
| ② Head end split side rail | ⑧ Accessory socket | ⑭ Castor |
| ③ Foot end split side rail | ⑨ Brake pedal / bar | ⑮ Lifting pole socket |
| ④ Attendant Control Panel (ACP) | ⑩ Roller buffer | |
| ⑤ Foot board | ⑪ Mattress extension catch bar | |
| ⑥ Bed stripper (linen shelf) | ⑫ CPR release handle | |

Technical Data

Safe Working Load (SWL):	250kg (550lbs)
Maximum patient weight:	185kg (407 lbs)
Recommended patient height:	146 to 190cm (57 to 74 ins.)
Product weight (without mattress):	144kg (317 lbs)
Operating temperature:	5°C to 40°C (41°F to 104°F)
Standard mattress size:	202 x 88 x 18 cm (79.5 x 34.6 x 7 ins)
Liquid ingress protection:	IPX4

Bed controls

- ① Power on indicator
- ② Battery indicator
- ③ Raise / lower mattress platform height
- ④ Raise / lower thigh section
- ⑤ Raise / lower backrest
- ⑥ Auto-Chair (described below)
- ⑦ Head down tilt (Trendelenburg)
- ⑧ CPR - hold down the button to return the bed to a flat position.
- ⑨ Foot down tilt (Reverse Trendelenburg)
- ⑩ Function lock / unlock
- ⑪ Bio-Contour (described below)

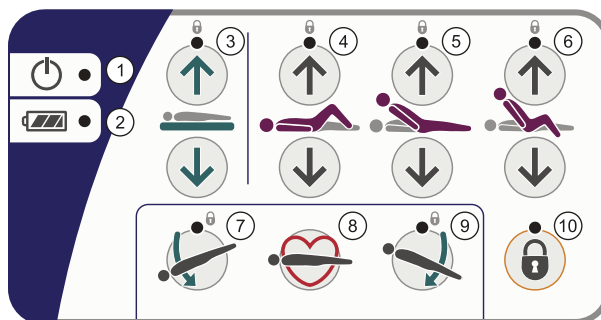



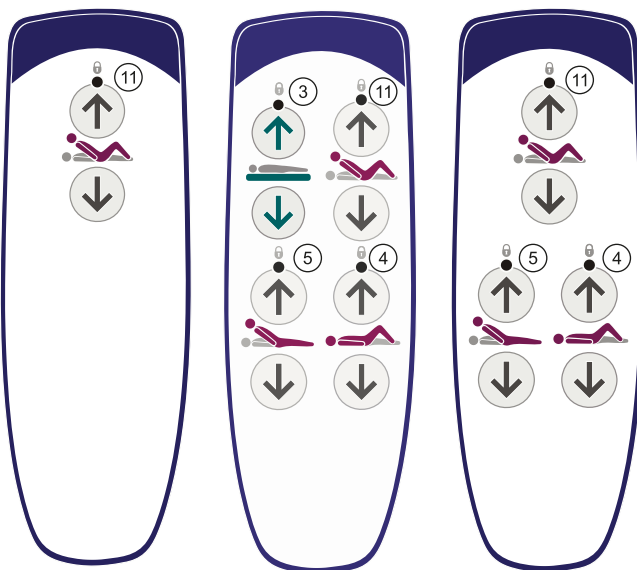

Attendant Control Panel (ACP)



Patient Handsets

Battery status indicator ②

-  ● Battery fully charged (indicator off)
-  ● Battery charging
-  ● Battery discharged



 A "beeping" sound indicates that the bed is operating on battery power. Connect the bed to the mains supply as soon as possible.

To operate controls

Select a function button for example **raise / lower mattress platform height**. The indicator light on the selected function will turn green and the bed will immediately begin to move accordingly.

- Green light indicates function selected.

Mattress platform height

-  Raise and lower the mattress platform. When lowered to 38cm (40cm on beds with 150mm castors) above the floor, it will pause then continue to lower until it reaches its minimum height.
- 

 At minimum height, clearance underneath the bed is reduced. Keep your feet away from the areas below the side rails and take extra care when using patient hoists or similar equipment.



Function lockout

-  Press the Function Lock button, then press the Attendant Control Panel button(s) corresponding to the function(s) to be locked or unlocked.



-  The "lock" indicator above the function button will light yellow when the function is locked and go out when it is unlocked.

- Yellow light indicates function is locked out.

Backrest



-  Raise and lower the backrest. The backrest will pause when it reaches an angle approximately 30° above the horizontal.
- 

Auto-Chair

-  The Auto-Chair up button simultaneously raises the backrest and thigh sections, pausing when the backrest reaches 45°. Continue to hold the button down to lower the foot end of the mattress platform into a chair position.
-  If the backrest angle is greater than 45°, it will return to 45° to prevent the patient from tipping forwards.

The Auto-Chair down button returns the mattress platform to a flat and level position.

Bio-Contour

-  The Bio-Contour up button simultaneously raises the backrest and thigh sections to provide upright patient profiling; the raised thigh section prevents the patient sliding down the bed.
-  The Bio-Contour down button returns the mattress platform to a flat position.

Brakes and steering

The brakes should be applied at all times when the bed is stationary. The pedals may be linked by a full width brake bar.

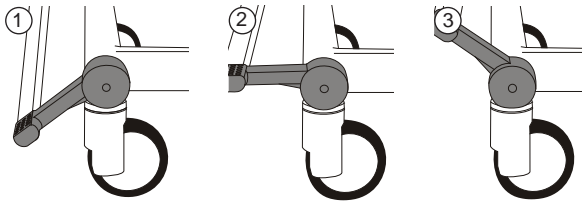

- 1 **Brake:** brakes are applied on all four castors.
- 2 **Free:** all four castors are free to rotate and swivel.
- 3 **Steer:** all four castors can rotate, but the steering castor (see below) is locked so that it cannot swivel. This helps to keep the bed on a straight line.

To use the steering castor: Position the bed so all castors line up in the direction of travel. Raise the pedals to lock the steering castor and move the bed by pushing it from the opposite end of the steering castor.

CPR backrest release

Pull the **red** manual CPR lever located on either side of the bed to quickly lower the backrest.

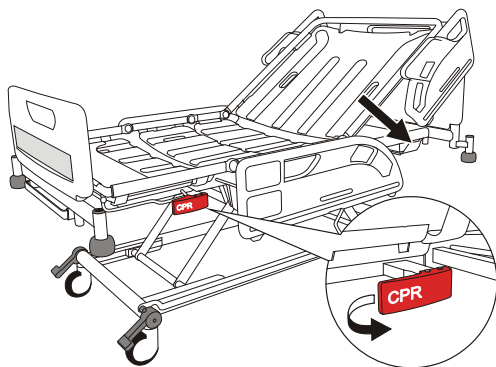

Mattress platform length adjustment

Lift the **blue** extension catch bar (1) and hold the middle of the crossbar (2), then pull the mattress platform to the required position (3).



Locking head and foot boards

The head and foot boards can each be fitted with optional locking catches (1) to prevent accidental removal. To unlock a board: pull out the **blue** catches (2) and rotate them a quarter-turn (3); the board can now be lifted off the bed.

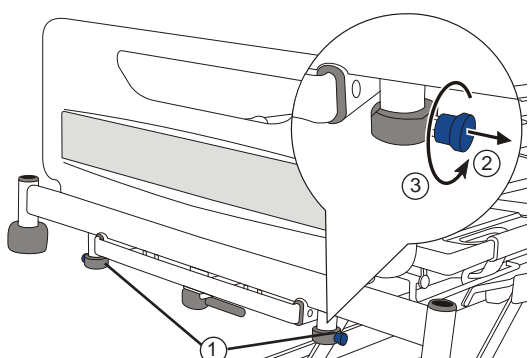

Side rails



Make sure the side rail is securely locked when in the raised position.

Pull the **blue** release lever (2) to lower the side rail. To raise the side rail, hold onto either side rail handle (1) and pull the side rail up and away from the bed until it locks in the raised position.

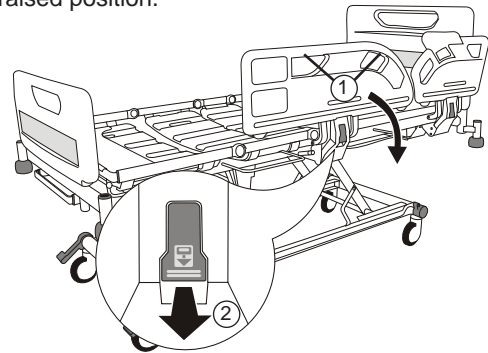

Bed length adjustment

Pull the **blue** extension locking handle locking handle (1). Pull out the bed frame (2) to the required position and release the handle. Adjust the mattress platform length to match the bed frame.

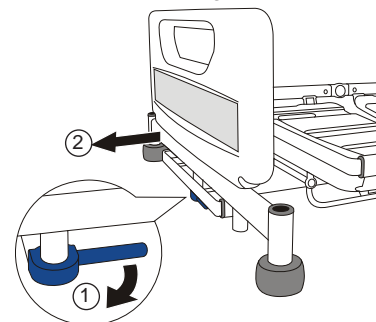

Calf section adjustment

Hold the side of the calf section frame and manually lift the calf section upwards (1) until it latches in the horizontal (vascular) position (2). Use the caregiver controls or ACP to lower the thigh section to the angled (Fowler) position.

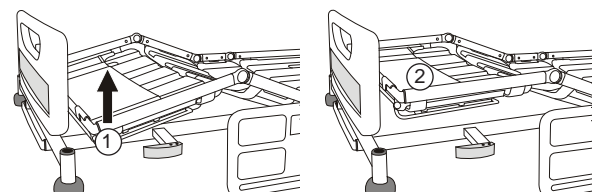

X-ray cassette tray (if fitted)

Apply the brakes. Remove the head board from the bed. Pull the knob (1) to release the catch and slide the tray out (2) as far as will go.

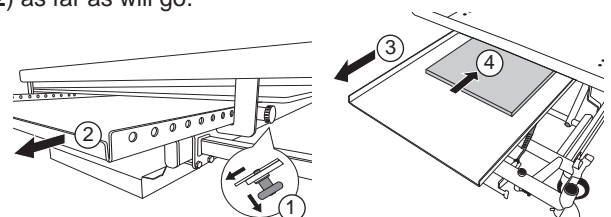

Release the knob to hold the tray in the fully open position (3). Position the X-ray cassette (4) on the tray with its bottom edge against the lip at the foot end of the tray. Pull the knob and slide the tray underneath the backrest. Release the knob to hold the tray in one of the latching positions.

Troubleshooting

If you experience any problems when using this product:

1. Refer to the Instructions for Use (part number 746-577) for further information.
2. Check the troubleshooting guide in the product service manual (part number 746-578).
3. For additional product information contact Arjo.

© and ™ are trademarks belonging to the Arjo group of companies. © Arjo 2019.

As our policy is one of continuous improvement, we reserve the right to modify designs without prior notice.
The content of this publication may not be copied either whole or in part without the consent of Arjo.

