

INSTRUCTIONS FOR USE

Sara Plus



WARNING

To avoid injury, always read this Instructions for Use and accompanied documents before using the product.



Mandatory to read the Instructions for Use

Design Policy and Copyright

® and ™ are trademarks belonging to the Arjo group of companies.

© Arjo 2019.

As our policy is one of continuous improvement, we reserve the right to modify designs without prior notice. The content of this publication may not be copied either whole or in part without the consent of Arjo.

Contents

Safety Instructions	3
Foreword	4
Consumables	4
Intended Use	5
Product Description/Function	6
Parts referred to in this manual	6
Controls and Features	7
Hand Control	7
Dual control panel	7
Emergency stop button (red)	7
Power on/Reset button (green)	8
Power off button (red)	8
Automatic cut out	8
Automatic stop function	8
OverHeat protection	8
System failure lower override	8
Battery Discharge Indicator	8
Hour/Cycle Meter	8
Chassis castor Brakes	8
Straight line steering function	8
Arc-Rest (with handgrips)	9
Foot Support	9
Proactive Pad™	9
Lower leg Straps.....	9
Adjustable width chassis legs	9
Commode Seat (Accessory)	10
Using your Sara Plus	11
Using the Sara Plus for Toileting and Transporting	11
Standing Sling	12
Transfer and Walking Sling	14
Arjo Scale (if fitted)	20
Battery Charging	21
Battery discharge indicator	21
Care and Preventive Maintenance	23
General Lift Care	23
Preventive Maintenance Schedule	24
Cleaning and Disinfecting the Toilet Commode Chair and Frame (if fitted)	26
Disassembly of the Commode Seat	26
Servicing Advice	27
Environmental Advice	27
Labels	28

Technical Specification 30
 Component Weights 30
 Electrical 30
 Maximum sound power level 31
 Environment..... 31
 End of Life Disposal..... 31
 Sara Plus Dimensions 32
Troubleshooting 33
Electromagnetic Compatibility 34

Safety Instructions

Symbols used adjacent to the text in these instructions:



Warning

This means failure to understand and obey this warning may result in injury to you or to others.



Caution

This means failure to follow these instructions may cause damage to all or parts of the system or equipment.

Note: This means this is important information for the correct use of this system or equipment.⁹



Warning: Before using the *Sara Plus*, a qualified health professional must carry out a clinical assessment of the patient to ensure that it is safe to lift them.



Warning: This equipment must only be operated by caregivers who have been trained in the correct use of this equipment and have read and understood the Instructions for Use.

This product has been designed and manufactured to provide you with trouble free use, however, this product does contain components that with regular use are subject to wear.



Warning: SOME OF THESE PARTS ARE SAFETY CRITICAL TO THE OPERATION OF THE LIFT AND WILL NEED EXAMINING AND SERVICING ON A REGULAR BASIS AND MUST BE REPLACED WHEN NECESSARY. See also “Care of your Sara Plus” section.



Warning: IMPORTANT: When using the transfer and walking sling for the transfer operation the maximum lifting capacity is 140kg (308lbs). When using the same sling for walking practice the maximum lifting capacity is 190kg (420lbs). Do not exceed these weight limits.



Warning: It is advisable to familiarise yourself and understand the operation of the various controls and features of the *Sara Plus* as described in “Product Description/Function” section in this manual and ensure that any action or check specified is carried out before commencing to lift a patient.

If you require assistance in the setting up, use or maintenance of the *Sara Plus*, or if you experience any unexpected operation while using it, please contact your local Arjo office. A list is given inside the back cover of this manual.



Warning: This equipment includes small parts that may present a choking hazard to small children if inhaled or swallowed.

Keep children and pets away from the equipment.



Warning: The hand control cable presents a possible strangulation risk. Take all necessary precautions to prevent this.



Warning: The operator/caregiver should not touch the connector of the hand control and the patient simultaneously.

Foreword

Thank you for purchasing Arjo equipment

Your *Sara Plus* is part of a series of quality products designed especially for hospitals, nursing homes and other health care uses.

We are dedicated to serving your needs and providing the best products available along with training that will bring your staff maximum benefit from every Arjo product.

Please contact us if you have any questions about the operation or maintenance of your Arjo equipment.

The touch panel label on the dual control panel displays several instruction symbols. The letter (i) shown on the open book icon indicates 'information', and is an instruction to always read the operating instructions before use. (See Fig 1).

The expected operational life of the *Sara Plus* is 10 (ten) years or 10,000 transfers, whichever is sooner. "Operational life" is defined as the period during which the product will maintain the specified performance and safety provided the following conditions are adhered to:-

- The unit is cared for and serviced in accordance with recommended, published "Operating and Product Care Instructions" and the "Preventive Maintenance Schedule".
- The unit is maintained to the minimum requirements as published in the "Preventive Maintenance Schedule".
- The servicing and product care, in accordance with Arjo requirements, must begin on first use of the unit by the customer.
- The equipment is used for its intended purpose only and is operated within the published limitations.



Warning: Unauthorized modifications or repairs to the *Sara Plus* may affect its safety and will invalidate any warranty. Arjo accepts no liability for any incident, accident or reduction in performance that may occur as a result of such repairs or modifications.

To maintain the safety of this equipment, always use only Arjo designated spare parts.

Consumables

The expected operational life for fabric slings and fabric stretchers is approximately 2 years from date of purchase. This life expectancy only applies if the slings and stretchers have been cleaned, maintained and inspected in accordance with the "Arjo Sling Information" documents, the

"Operating and Product Care Instructions" and the "Preventive Maintenance Schedule".

The expected life for other consumable products, such as batteries, fuses, lamps, gel cushions, filters, seal kits, seat inserts, mattresses, safety belts, padded covers, straps and cords is dependent upon the care and usage of the equipment concerned. Consumables must be maintained in accordance with published "Operating and Product Care Instructions" and the "Preventive Maintenance Schedule".

All references to the patient in these instructions refer to the person being lifted, and reference to the attendant refer to the person who operates the lift.

References to left and right of the lift in these instructions are as viewed from the rear of the *Sara Plus*, i.e. viewed from the dual control panel (see Fig. 1)

Lifting operations in these instructions are described as if lifting a patient from a chair, the same operations can be performed effectively when lifting a patient from a wheelchair or sitting position on a bed, although a second attendant should support the patient if the patient lacks sitting balance.

All operations in these instructions are described as if the attendant were using the hand control. Each operation described can be controlled using the hand control and/or the dual switch panel, situated at the rear of the mast.

The *Sara Plus* is manufactured to a very high standard, and primarily designed to assist patients when standing and toileting, for use as a short distance patient transfer aid, and for standing and walking practice.

When used as a standing aid the *Sara Plus* is extremely useful for quick easy transfers from one sitting position to another, and to elevate a patient for toileting, repositioning, changing of incontinence pads or wound dressings, standing practice etc. it is not intended for long periods of suspension or transportation.

Some information contained in these instructions may become outdated, due to improvements made to this product in the future. If you have any questions regarding these instructions or your lift, please contact Arjo or their approved distributor.

If a serious incident occurs in relation to this medical device, affecting the user, or the patient then the user or patient should report the serious incident to the medical device manufacturer or the distributor. In the European Union, the user should also report the serious incident to the Competent Authority in the member state where they are located.

Product Description/Function

Intended Use

Sara Plus is a standing and raising aid for short transfers e.g. raising from bed and transfer to wheelchair, or from wheelchair to toilet. *Sara Plus* is also suitable for walking training when the footboard and kneepad are removed.

Sara Plus is intended to be used in hospitals, nursing homes or other health care facilities for the different categories of residents/patients.

Category C, where the resident/patient:

- Sits in a wheelchair
- Is able to partially bear weight on at least one leg
- Has some trunk stability
- Is dependent on the caregiver in most situations
- Needs mobility-maintaining standing exercises

Category D, where the resident/patient:

- Sits in a wheelchair
- Is dependent on the caregiver in most situations

Sara Plus is the only standing and raising aid where a resident/patient such as Category D, can safely be raised and transferred. The unique support of the EPS (Extra Postural Support) /BOS sling makes it feasible.

Before attempting to use *Sara Plus*, a full clinical assessment of the patient/resident condition and suitability must be carried out according to above by caregiver.

Sara Plus shall only be used after the patient/resident has been carefully assessed by a caregiver trained in following the instructions for use or the patient/resident's clinician.

Sara Plus shall always be handled by a trained caregiver and in accordance with the instructions outlined in these Operating and Product Care Instructions.

Sara Plus is intended to be used with specifically designed Arjo slings

Lifting operations in these instructions are described as if lifting a patient from a chair, the same operations can be performed effectively when lifting a patient from a sitting position on a bed, although a second attendant should support the patient if the patient lacks sitting balance.



Caution: Although manufactured to a high standard the *Sara Plus* and its accessories should not be left for extended periods in humid or wet areas.

Do not under any circumstances spray the *Sara Plus* or accessories (excluding slings) with water e.g. under a shower.

Product Description/Function

Parts referred to in this manual

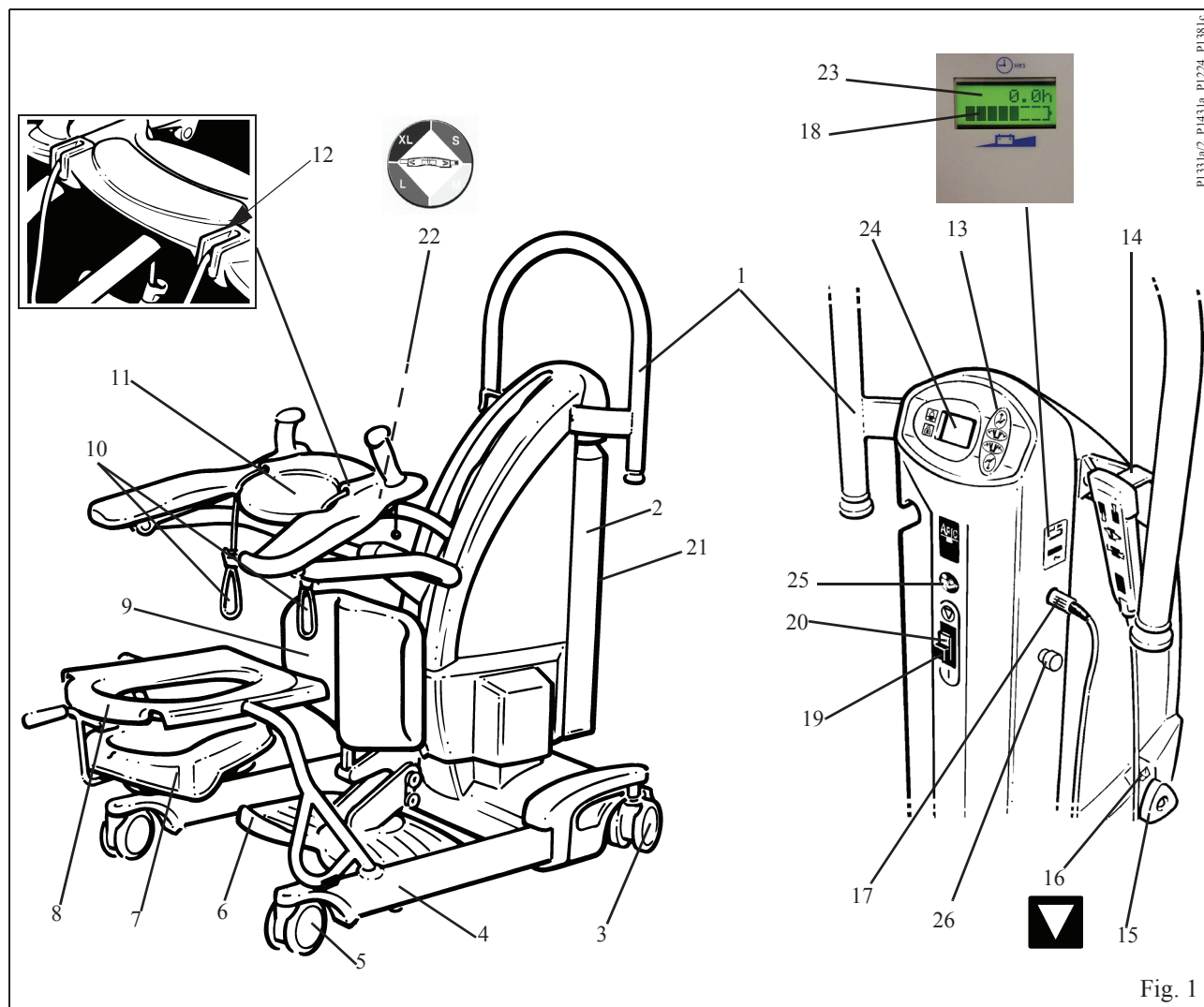

Fig. 1

PI331a/2, P1431a, P1224, P1381c

- | | |
|---|--|
| 1. Manoeuvring handle | 16. Label - System failure lower override identification |
| 2. Battery pack | 17. Handset cable connection |
| 3. Braked castors (rear) | 18. Battery discharge indicator |
| 4. Chassis legs | 19. Power on/Reset button (green) |
| 5. Front castors (unbraked) | 20. Power off button (red) |
| 6. Foot support (removable) | 21. Label - Read operating instructions before use |
| 7. Commode pan (optional) | 22. Label - Sling size guide |
| 8. Commode seat and frame (optional) | 23. Hour/Cycle meter |
| 9. Proactive Pad™ (Adjustable) | 24. Scale display panel (if fitted) |
| 10. Sling attachment cords | 25. Label - Read operating instructions before use |
| 11. Arc-Rest™ (Supportive arm rests with handgrips) | 26. Emergency stop button |
| 12. Detail view of cord locking cleats | |
| 13. Dual control panel | |
| 14. Hand control | |
| 15. System failure lower override knob | |

Product Description/Function

Unpack the battery pack supplied, and fully charge it until the charger indicates full charge, see "Battery Charging section". When the battery pack is charged, disconnect the mains power, then remove the pack from the charger and insert it fully into the *Sara Plus* battery position, located at the left hand side of the lift. Locate the recess in the bottom of the battery with the protrusion at the bottom of the battery position then pivot the battery into position until the retaining catch operates. Electrical connection is made automatically.

Ensure that the green reset button situated on the back of the lift cover is pressed in. (see inset to Fig. 1).

Check that the system failure lower override knob is turned fully clockwise and finger tight, (see Fig. 1).

Ensure that both sling types are available for the types of lift likely to be encountered when using the *Arjo Sara Plus*.

Two types of sling can be used with the *Sara Plus*.

Standing Sling – a single loop, used for supporting patients at the toilet, and to aid in the standing process. The sling has a 'fleece' cover for added comfort, which can be easily removed for cleaning.

Transfer and Walking Sling – A loop sling with back, buttock and leg support, used for easy and comfortable transporting of patients over short distances without the need for the detachable seat frame. By using different attachment straps the same sling can be used for supporting patients during the training procedure of standing, stepping and walking under the supervision of trained nursing staff. The sling has variable adjustment.

Note: The slings have colour coded connection loops for size identification, as follows:-

- Red - Small (S)
- Yellow - Medium (M)
- Green - Large (L)
- Blue - Extra Large (XL)

A circular label is fitted to the central lifting tube for quick colour to size reference. (see fig 1)

Controls and Features

Hand Control:- The hand control is attached to the lift by an extending cable. The handset controls lift and lower and chassis leg opening/closing. Direction arrows adjacent to the buttons indicate each function. (See Fig. 2). If pressure is released from any button during use, powered movement will stop immediately.

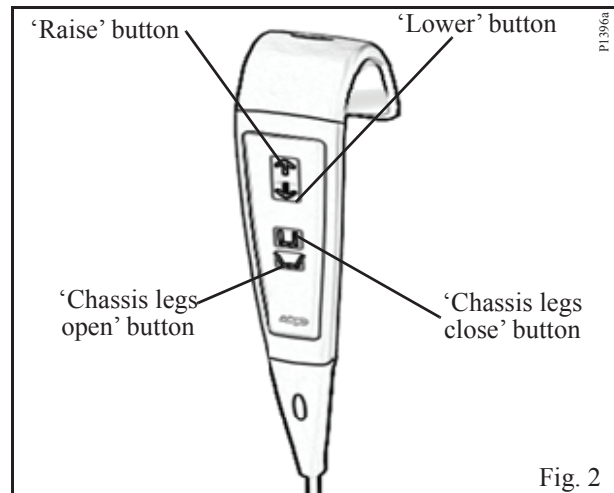
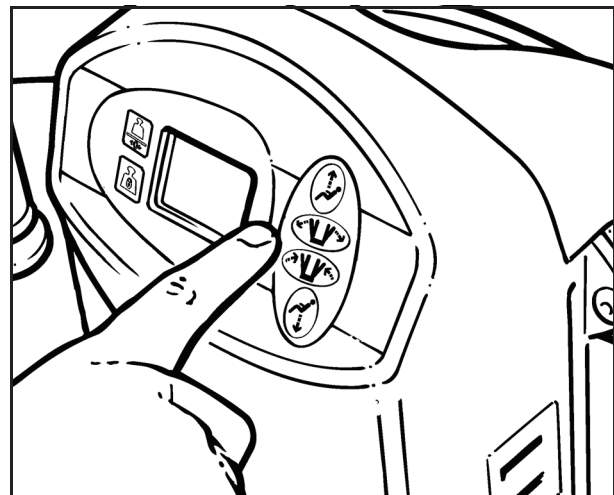

Fig. 2

Dual control panel:- offers the same controls as the handset and is conveniently positioned on the top of the main body of the lift (See Fig. 3).



Emergency stop button (red):- (see Fig. 1) If, in an emergency, you have to immediately stop any powered movement, (other than by releasing pressure on the button either on the handset or dual control panel), press the emergency stop button situated on the side of the cover. (See Fig. 1).

Once the emergency stop button has been operated, it must be reset by turning the red cap until it pops back out, before any further powered movement can be utilised.

Product Description/Function

Power on/Reset button (green):- (see Fig. 1) On the rear of the case below the dual control panel. Press this button to turn on power to the lift. Also used to reset if the automatic overload fuse has operated (indicated by the button projecting outwards slightly). If the fuse has operated and once reset, operates again, withdraw the lift from use and contact Arjo Service department or their appointed distributor.

Power off button (red):- (see Fig. 1) On the rear of the case below the dual control panel. Press this button to turn off power to the lift.

Automatic cut out:- (not an operator control but a function built into the lift electronics).

If the *Sara Plus* is inadvertently overloaded (trying to lift a patient heavier than permitted), an automatic 'cut out' operates to prevent the lift raising a load in excess of the safe working load; this will stop the lift motion automatically. 'overload' occurs on the Hour/Cycle meter and the Buzzer beeps continuously when any button is pressed.

If this occurs, when pressure is released from the lift button on the handset or dual control the electronics will reset. 'overload' disappears from the Hour/Cycle meter. The patient can now be lowered, by pressing either lower button. Remove the patient from the lift.

Automatic stop function:- Great care should be taken not to lower the patient support arms onto the patient or any other obstruction but if this should happen inadvertently the motor will continue to run but downward movement will be held by the obstruction. If this occurs release pressure from the 'lower' button immediately, operate the 'raise' button until clear, then remove the obstruction.

OverHeat protection:- Buzzer beeps twice with interval 15 seconds and 'OverHeat' is displayed on the Hour/Cycle meter when operator exceeds duty cycle for mast actuator (2min/18min), movement is still possible. The function protects the actuator from damage.

System failure lower override:- This can be used in the event of main control failure. In the unlikely event that the hand control or dual control panel fails to operate the lift, with a patient still supported by the sling, provision for lowering has been made, using the "lower override knob", situated on the right hand side of the main cover (see Fig. 4). A label situated above the switch is for quick and easy recognition (see Fig. 1) To operate the lower override, turn the knob anti clockwise half a turn, to cease lowering turn the knob clockwise until finger tight only (do not over tighten), only use this knob in the event of normal control failure do not use it for normal function lowering.



Warning: Before operating the lower override to lower a patient, always ensure that a chair or suitable support is underneath ready to accept the patient.

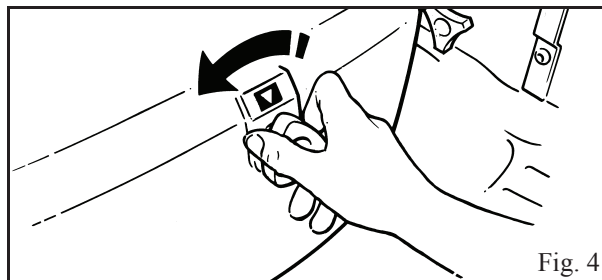

Fig. 4

The lower override will operate whether the emergency stop button has been operated or not. The "automatic stop function" of the jib will still operate when using the lower override knob.

When using the *Sara Plus* normally, always ensure the system failure lower override knob is always turned fully clockwise and finger tight.

Battery Discharge Indicator:- (see Fig. 1) There is a small battery symbol on the bottom of the LCD. The battery symbol shows the level of battery charge.

Hour/Cycle Meter:- (See Fig. 1) The upper line of the display shows the total duration of lifting and lowering operation in hours. The display can also show the number of cycles by pressing the raise and lowering buttons at the same time. This is intended as an aid to help calculating the service intervals.

Chassis castor Brakes:- The chassis rear castors have brakes which can be foot operated if required, (see Fig. 5) for example, when leaving the patient unattended, or to keep the *Sara Plus* in position.

Straight line steering function :- When using the *Sara Plus* for walking practice it may be considered useful to fix one of the castors to steer in a straight line. This has the effect of allowing the *Sara Plus*, without assistance to follow the intended straight line walked by the patient. The function is activated by flipping over the steering guide on the rear castor to hold it in position (see Fig. 5).

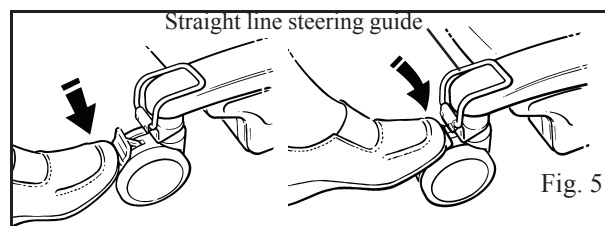

Fig. 5

Product Description/Function

Arc-Rest (with handgrips):- Integral Part of the Lifting mechanism of the lift, the intuitive and supportive armrests allow patient participation and comfort during the lifting procedure. (See Fig. 1)

Foot Support:- For positioning the patient's feet when lifting and transporting, it can be removed if using the *Sara Plus* to lift a patient to their feet prior to them using a walking aid eg. "Zimmer" etc. To remove the foot support, raise the Proactive knee support to its highest position, (note: where installed, unclip one side of the hook and loop tie strap from around the foot support cover and slide the cover up the knee support column). Position yourself between the chassis legs and grip both sides of the foot support, lift up the front half of the foot support until it just comes into contact with the foot support bracket (see fig. 6), whilst it is in this position pivot the rear of the foot support upwards until the foot support is horizontal. Pull the foot support towards yourself until it is clear of the support bracket. Store carefully for future use.

Slide the foot support cover back down into position and secure using the hook and loop strap. Re-adjust the Proactive kneepad to the position required.

Re-fitting the foot support is achieved by reversing the above procedure. Note: Ensure the two hooks on the foot support locate over the top two locating buttons.

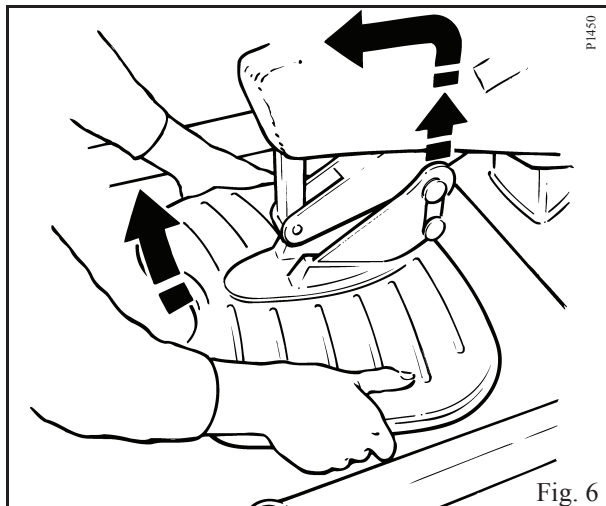

Proactive Pad™:- This is a reactive lower leg support (Fig. 1 and 7), which enables the patient to be lifted comfortably and effortlessly. It can be adjusted vertically for differing lower leg lengths and is sprung to stay in contact, when the patient's legs move radially during the lifting procedure. To adjust, hold the Proactive Pad™ with one hand (see Fig. 7) and slacken the clamping screw knob with

the other hand. When the correct height has been established re-tighten the knob.

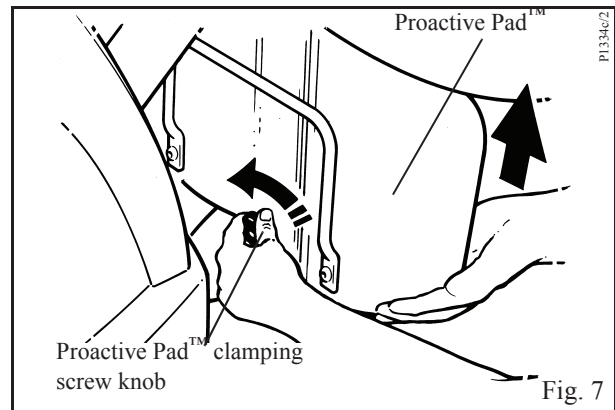

It can be removed from its mount quickly, for walking practice, simply by lifting upwards, after the foot support has been removed.

Lower leg Straps:- An optional accessory used for ensuring the lower parts of the patient's legs stay in close proximity to the Proactive Pad™ for correct lifting procedure.

The Strap ensures the lower parts of the patient's legs stay in close proximity to the Proactive Pad for correct lifting procedure. The strap is held in position in relationship to the Proactive Pad by passing through the guides on the back of the Proactive Pad then around the patients lower calves to be finally overlapped and pressed together to join the hook and loop strap fastening. (See Fig. 8). Ensure the strap is firm but comfortable for the patient

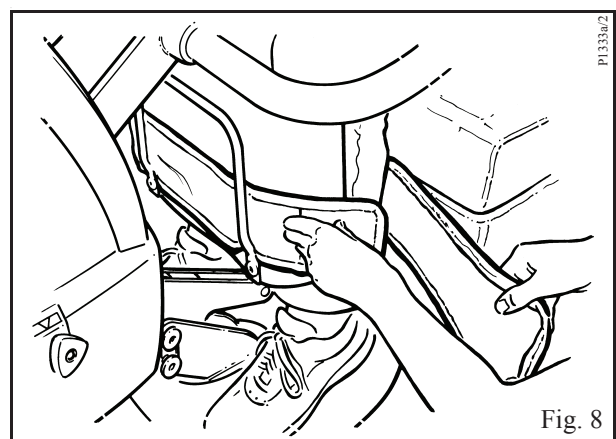

Adjustable width chassis legs:- By operating the appropriate button on either the hand control or dual control panel on the lift the chassis legs can be opened to any variable width (See Fig. 9). When pressure is released from the button, movement will stop and the chassis legs will remain securely in position.

Product Description/Function

Note: Transportation should be done with the chassis legs closed, it will be easier through doorways etc.

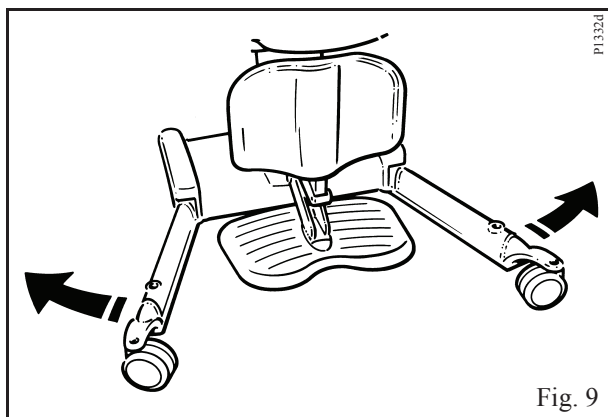

Fig. 9

rear of the seat, (see Fig. 11), may be utilised, or removed to enable the patient to be positioned over a toilet. Apply chassis brakes if leaving the patient unattended.

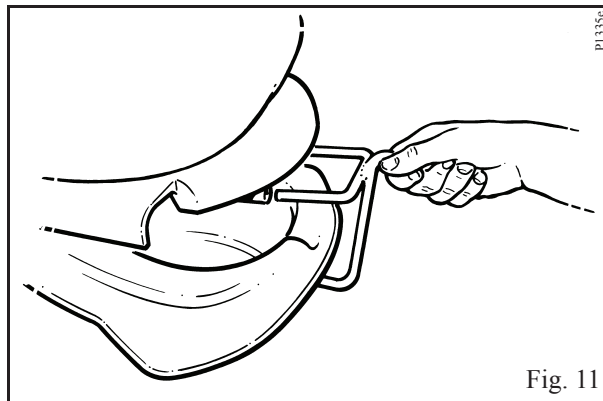

Fig. 11



Warning: At all times the patient and/or operator should not allow their feet or any other part of their body to be placed in the area between the foot support and chassis legs when the chassis legs are closing.

Commode Seat (Accessory)

For toileting patients at the chair or bedside or for patients who cannot be transported with the transfer sling, the use of the commode seat and frame is the recommended method of transporting patients over longer distances. The commode frame is inserted into the holes in the chassis legs (see Fig. 10), once the patient has been lifted to a standing or near standing position in the manner previously described.

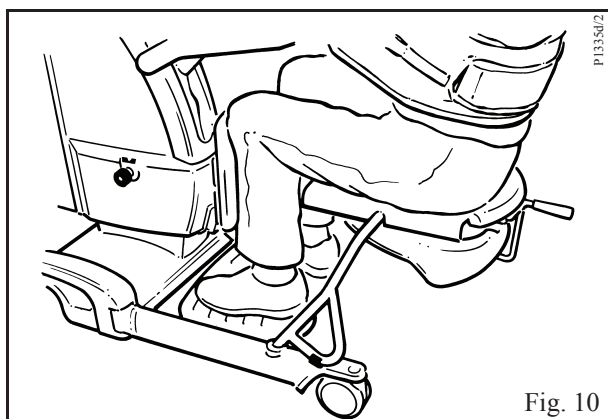

Fig. 10

Removal of any clothing can be attended to, and the patient is then lowered down onto the commode seat. It is recommended that the patient is kept supported by the sling.

The retractable commode pan, accessible from the

Using your *Sara Plus*

Using the Sara Plus for Toileting and Transporting

Before approaching the Patient the attendant should always tell the patient what they are going to do, and have the correct size and type of sling ready. (See description of sling types in the “Introduction” section.)

Although the sling can be fitted to the patient with the *Sara Plus* in close proximity it may be considered easier to fit the sling to the patient with the *Sara Plus* away.

Once the sling has been fitted (see following sections) the *Sara Plus* may be brought to the patient as follows:-

Adjust the height of the Patient Support arms to be raised or lowered sufficiently to avoid approaching the patient at eye level, making allowances for the patients arms and any obstructions, e.g. chair arms etc.

Approach the patient from the front with the lift, stop before the foot support and Proactive Pad™ are in contact with the patient. (See Fig. 12)

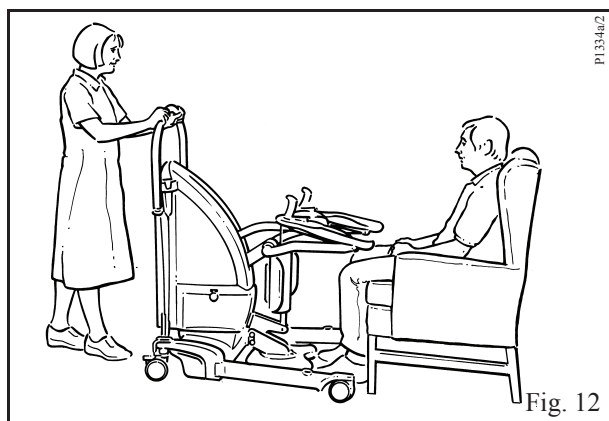

Fig. 12

Note: *If required, the chassis legs may be opened to go around the chair, by operating the appropriate button on the hand control or dual control on the lift.*

Note: *If the handset button or dual control button is released during any function, powered motion will stop immediately.*

When the patient is ready, give assistance or allow the patient to place his/her feet on the foot support, pushing the *Sara Plus* towards the patient a little to achieve this easily. (See Fig. 13).

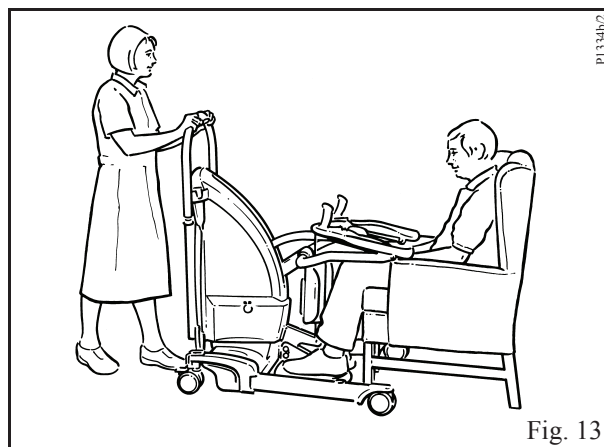

Fig. 13

Adjust the Proactive Pad™ height (if necessary) – an approximate guide is to align the top of the Proactive Pad™ just below the patient's patella. (See Fig. 14).

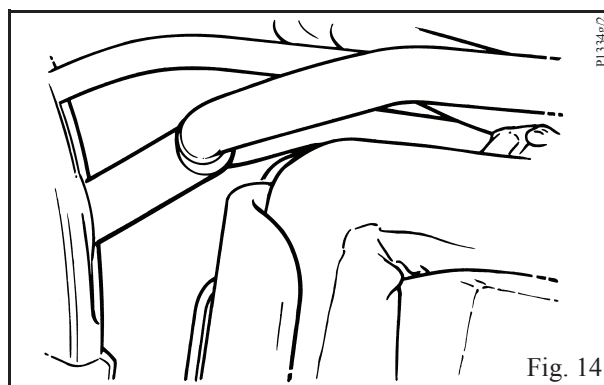

Fig. 14

Carefully push the lift in closer to make full lower leg contact with the Proactive Pad™ (see Fig. 15), then apply the chassis brakes.

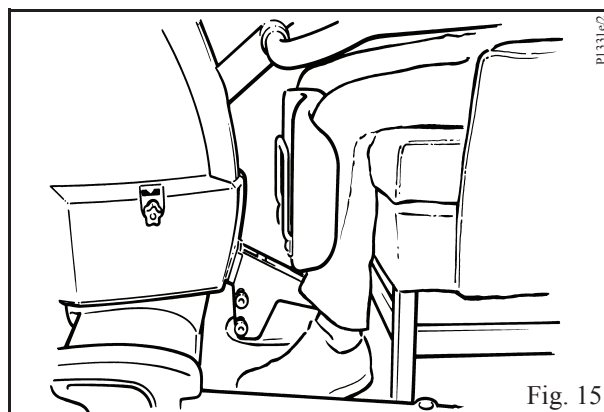

Fig. 15

For the use of each individual type of sling see following sections:

Using your Sara Plus

Standing Sling



Warning: Assessment will have to be made whether the patient requires the lower leg straps, apply if necessary.

Allow the patient to hold the handgrips, with their arms resting on the Arc-Rest. This will not apply if fitting the sling around the patient before the Sara Plus is brought into close proximity.

Encourage the patient to lean slightly forwards to enable the sling to be placed around the lower back of the patient (see Fig. 16). Position the sling around the patient's back so that the bottom of the sling lies horizontally approximately two inches above the patient's waistline, with the patient's arms outside the sling. Ensure the support strap is separated, brought loosely around the body, and is not twisted or trapped behind the patient's back.

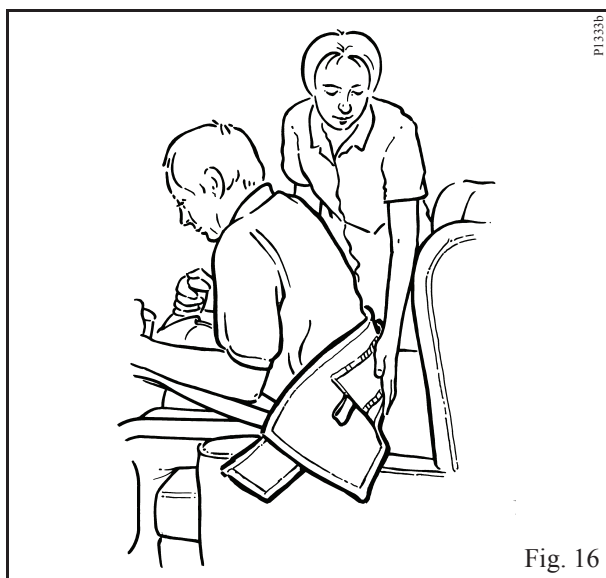

Fig. 16

Fasten the support strap securely by overlapping and pressing the hook and loop straps together. The strap should be tight, but comfortable for the patient. (See Fig. 17).

Note: As stated previously, the standing sling may be applied before the Sara Plus is brought into position as shown in figure 13.



Warning: The support strap must always be applied when using any of the slings.

Note: The support strap will assist in supporting the patient in the sling during the lifting procedure. The strap also retains the sling in the correct position around the patient.

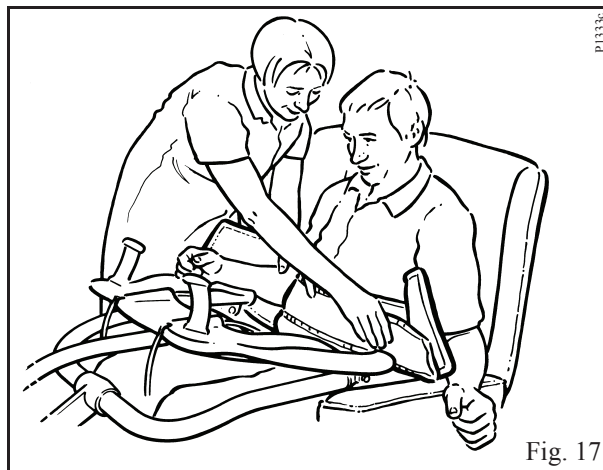

Fig. 17

If the Sara Plus is not already in close proximity to the patient bring it to the patient as described previously.

Take each adjustment cord in turn and attach to the sling. (See Fig. 18).

Fitting the Loop Lock cord attachment system

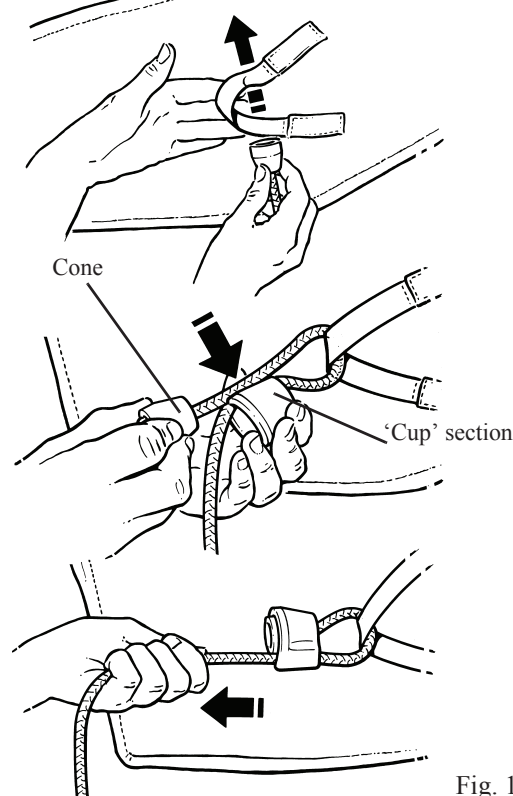

Fig. 18

Using your Sara Plus



Warning: Ensure the cone is pulled tightly into the cup section. (See Fig. 18).

When both cords are attached correctly make adjustments on both cords equally so that any slack is taken up in each cord and the back section of the sling supports the patient comfortably and securely, lock the adjustment cords down into the cord retaining cleats. (See Fig. 19).



Warning: Ensure the cord end knobs are away from the proactive pad™ when the patients legs are near or in contact with the pad.

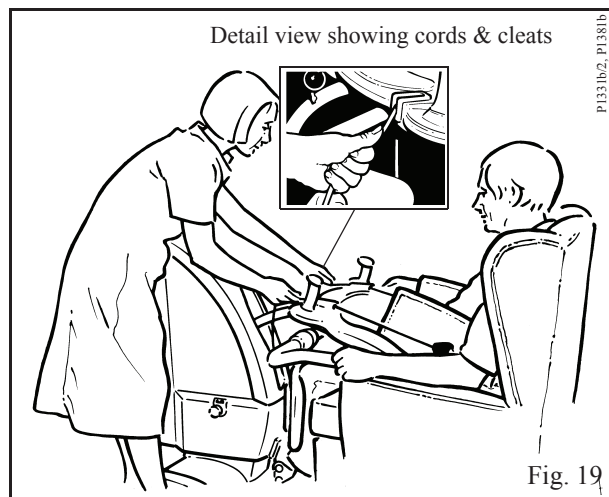

Fig. 19

Note: The patient should be supported by the sling, but not pulled forward too much. (See Fig. 20)

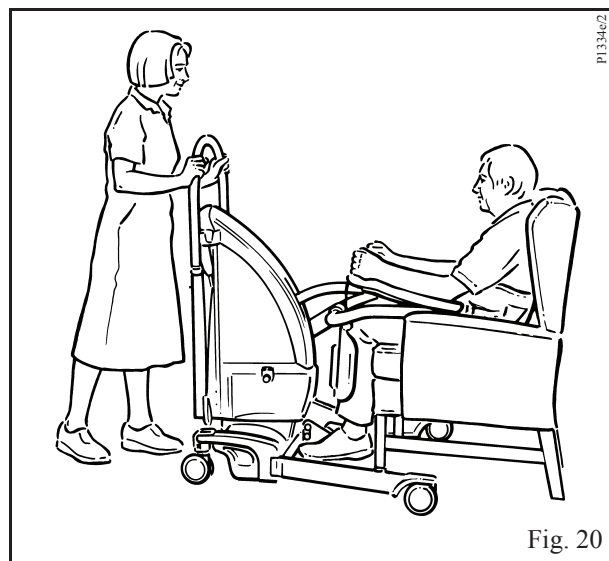

Fig. 20

If possible, the patient should then hold on to the Patient Support arms with one or both hands.

The patient is then ready to be lifted.

Note: If the handset button or dual control button is released during lifting or lowering powered motion will stop immediately.

If the patient is able to offer some assistance when standing this may be beneficial to patient confidence and muscular exercise. Encourage the patient to assist all he/she can to raise from the chair and/or steady themselves.

Operate the lift button on the handset or dual control panel to raise the patient to a suitable and comfortable height for the particular function, e.g. transportation, toileting with commode, etc. (See Fig. 21)

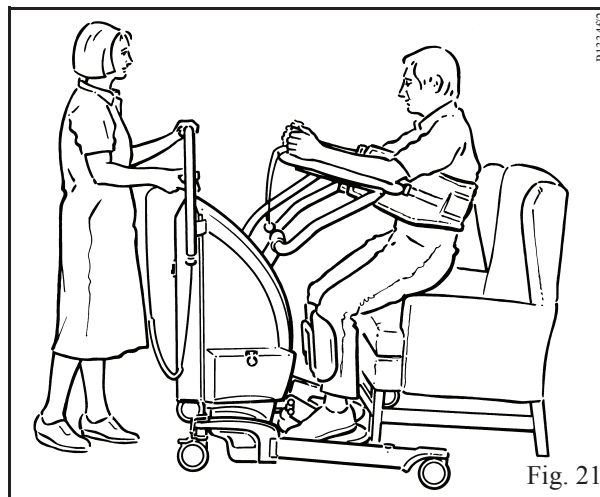

Fig. 21

IMPORTANT: Always check that the sling adjustment cords are fully in position and locked before and during the commencement of the lifting cycle, and in tension as the patient's weight is gradually taken up.

Note: If the patient can stand sufficiently well and lock his/her knees in the normal way when fully raised, their knees will come away from the Proactive Pad™ and he/she will be able to lean back into the sling.

Patients who can only hold on with one hand, (those who have suffered a "stroke", for example) may still be lifted by using the Sara Plus. The patient may just rest the unusable arm on the Arc-Rest or hold it across their chest, and rest their elbow on the end of the Arc-Rest, while their usable hand holds the handgrip in the normal way.

Using your Sara Plus



Warning: Only use this or other methods after a satisfactory professional assessment has been carried out on the individual patient.

If required insert the detachable seat frame into the receptor holes in the chassis legs, then lower the patient to a comfortable seating position for commode toileting or longer distance transportation. (See Fig. 22).

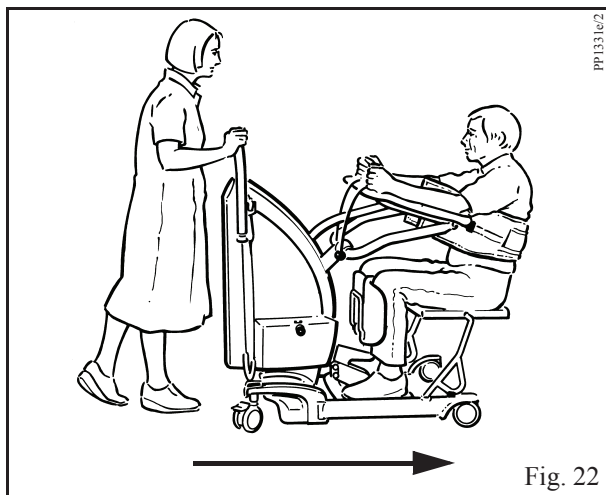

Fig. 22

Note: The chassis legs will have to be adjusted to the closed position to fit the seat frame.

Release the brakes, and transfer the patient to new position, i.e., toilet, wheelchair, chair, bed, etc.

Note: Transportation should be done with the chassis legs closed, it will be easier through doorways etc. Always move in the direction shown in Fig. 22.

While the patient is raised, make any necessary adjustments to clothing, incontinence pads etc., before lowering again. Lower the patient carefully using the hand control or dual control panel.



Warning: Apply the chassis brakes if leaving the patient at the toilet, or if leaving the patient unattended.

When the patient is seated in the new position, and you wish to remove the sling.

Pull each cord up from the locking cleats and slacken the cords sufficiently to release the Loop Lock™ fitting, then remove the cords from the sling.

Pull apart the hook and loop strap fastening to remove the support strap.



Warning: Do not attempt to release the support strap while the patient is supported by the sling.

Remove the sling from the patient.

Remove the lower leg straps if they have been applied.



Warning: If the patient lacks sitting balance and has been returned to sit on the side of the bed a second attendant may be needed to support the patient while the sling is being removed.

Transfer and Walking Sling

Using the sling for transfer (140 kg - 308 lbs maximum patient weight):- The attendant should always tell the patient what they are going to do, and have the correct size and type of sling ready. (See description of sling types in the “Introduction” section.)

Encourage the patient to lean slightly forwards to enable the selected sling to be placed around the lower back of the patient (see Fig. 23). Position the sling around the patient's back so that the bottom edge of the sling is level with the base of the spine. Ensure the patient's arms are outside the sling and that the support strap is separated.

Take each leg section of the sling in turn and slide under each leg, (see Fig. 24).

Bring the support strap around the body and fasten securely by overlapping and pressing the hook and loop straps together.

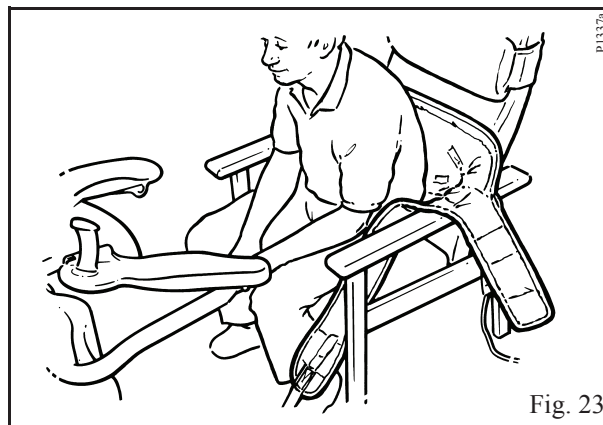

Fig. 23

Take each leg section of the sling in turn and slide under each leg, (see Fig. 25).

Using your Sara Plus

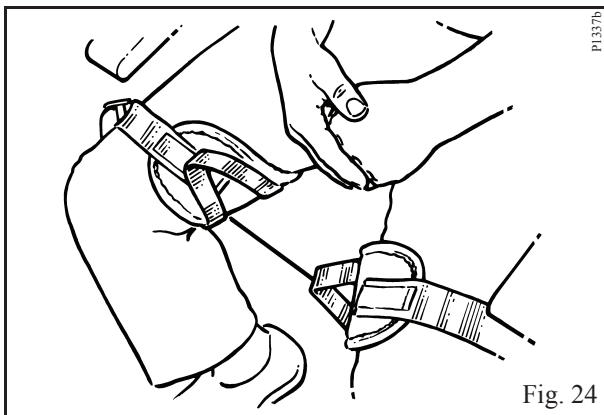

Fig. 24

Note: The support strap will assist in supporting the patient in the sling during the lifting procedure.

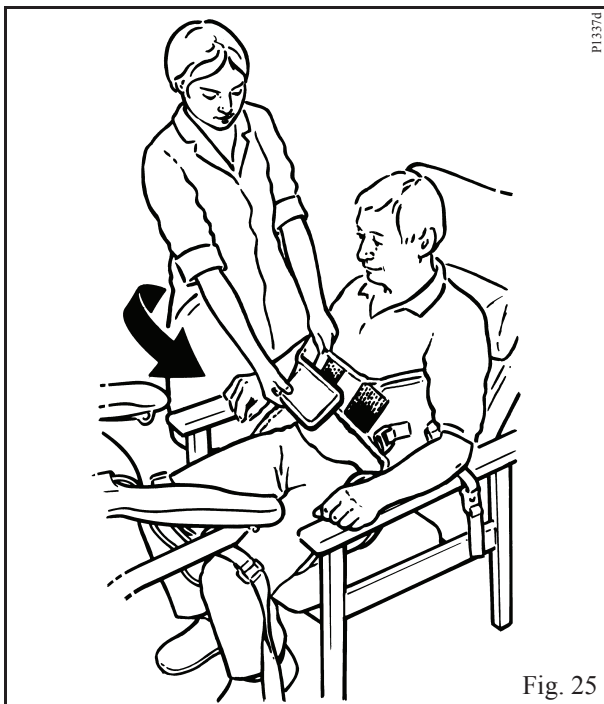

Fig. 25

The strap should be tight but comfortable for the patient. (See Fig. 26).

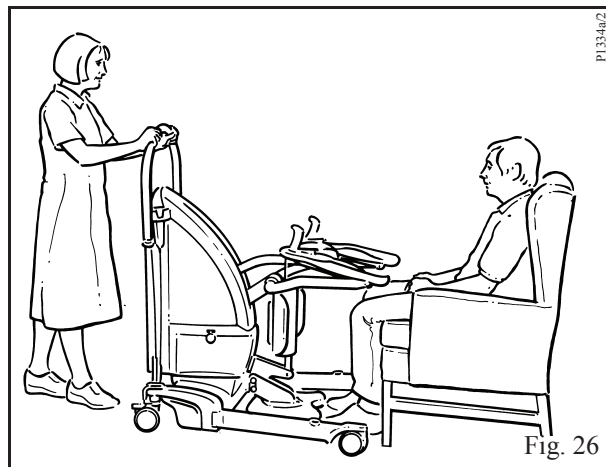

Fig. 26

Note: If required, the chassis legs may be opened to go around the chair, by operating the appropriate button on the hand control or dual control on the lift.

Note: If the handset button or dual control button is released during any function, powered motion will stop immediately.

Give assistance or allow the patient to place his/her feet on the foot support, pushing the Sara Plus towards the patient a little to achieve this easily. (See Fig. 27).

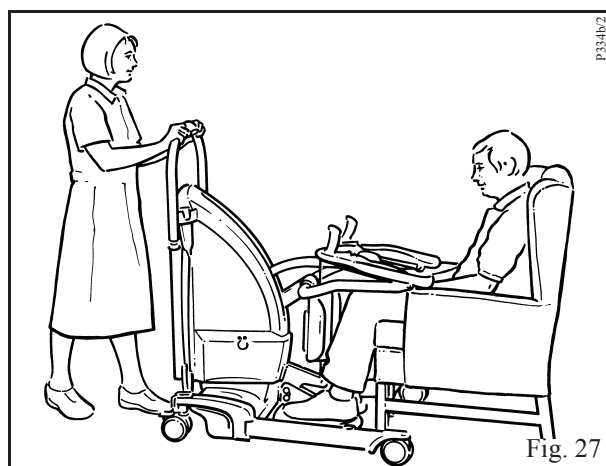
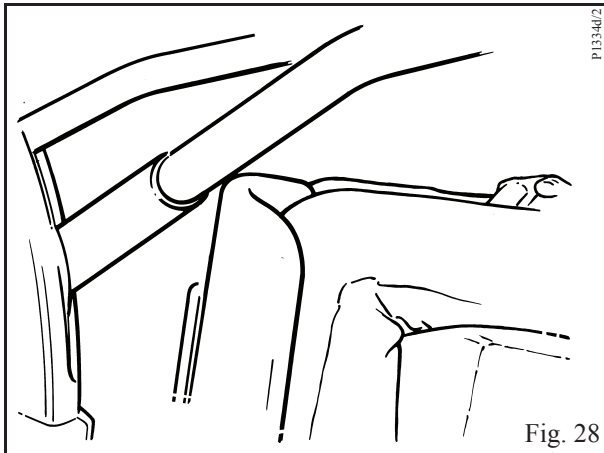

Fig. 27

Adjust the Proactive Pad™ height (if necessary) - to align the top of the Proactive Pad™ just above the patients patella, or adjust the pad to its highest position. (see Fig. 28).

Using your Sara Plus



Identify the attachment loop on each side of the sling and attach the right hand adjustment cord to the left loop, repeat for the other side (see Fig. 29). See also Fig. 18 for attachment of the cords.

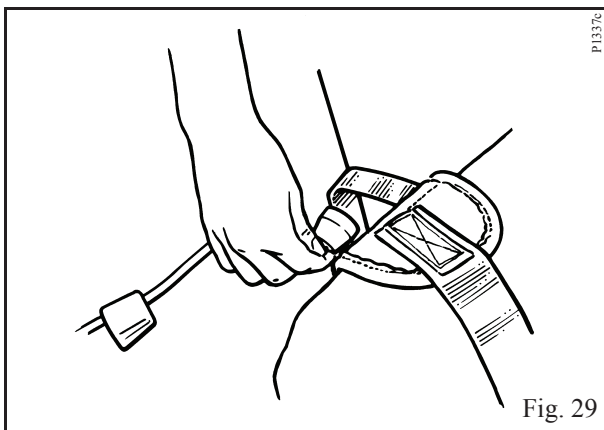

When both cords are attached correctly make adjustments on both cords equally so that any slack in the cord is taken up.



Warning: Lock the adjustment cords down into the cord retaining cleats (see also Fig. 30).



Warning: Ensure the cord end knobs are away from the proactive pad™ when the patients legs are near or in contact with the pad.

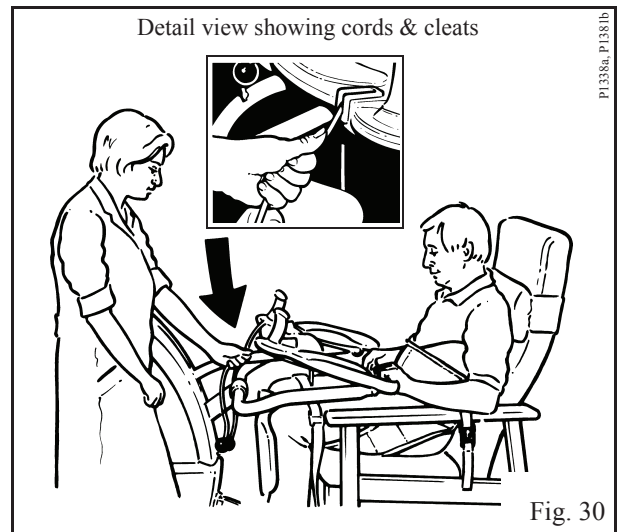

Identify the support strap on each side of the sling (fitted with a plastic attachment clip), and adjust both straps to their maximum length. Attach each clip to the lug situated on the outer sides of the Arc-Rest (see Fig. 31).

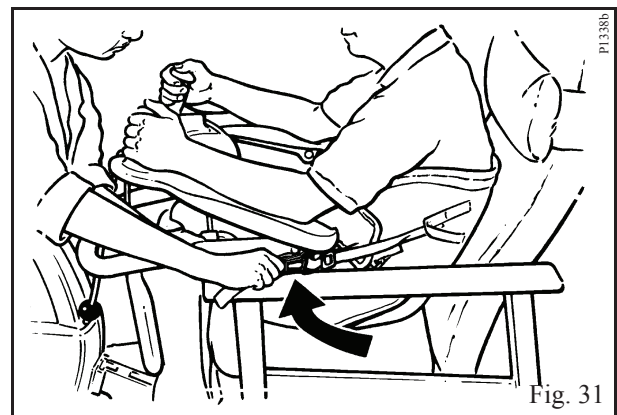

Warning: Ensure each clip is attached correctly and secure onto the lug.

Allow the patient to hold the hand grips with their arms resting on the Arc-Rest.

Operate the lift button on the handset or dual control panel, continue to raise until each support strap is in tension and the patient's back just comes away from the chair, then stop the lift. Then adjust both cords equally to take up any slack, lock both cords into the locking cleats. (See Fig. 32).

Continue raising until the patient is just clear of the seat.

Using your Sara Plus

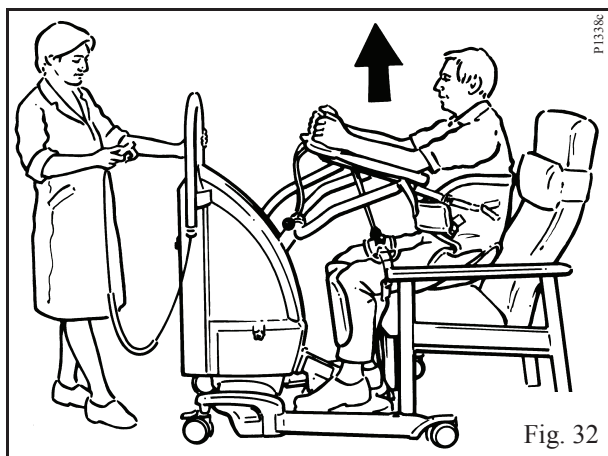

Fig. 32

If any discomfort is experienced by the patient return to the sitting position and re-adjust.



Warning: Important: Always check that the sling adjustment cords and support strap attachment clips are fully in position and locked before and during the commencement of the lifting cycle, and in tension as the patients weight is gradually taken up.

Be careful not to raise the patient too high as this will negate the comfort of the transfer sling.

Release the chassis brakes and close the chassis legs, then transport the patient to desired position. (See Fig. 33).

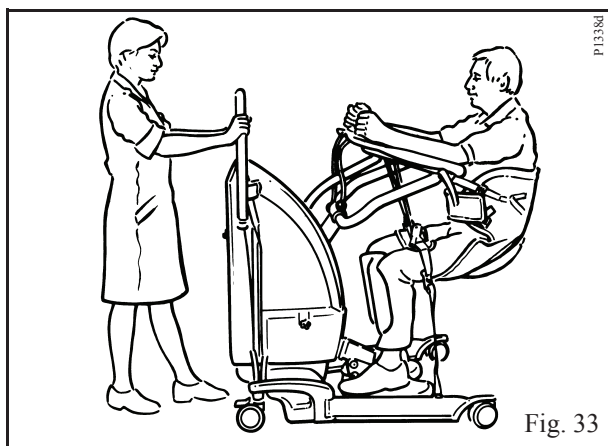

Fig. 33

Transportation should be done with the chassis legs closed, it will be easier through doorways etc.



Warning: Apply the chassis brakes if leaving the patient unattended.

Do not attempt to release the straps or cords while the patient is supported by the sling.

Using the sling for walking practice - (190 kg - 420 lbs maximum patient weight):-

Remove the foot support from the lift and store carefully for future use (see “Product Description/Function” section in this manual).

As with all types of lift, before approaching the patient the attendant should always tell the patient what they are going to do, and have the correct size and type of sling ready.

Encourage the patient to lean slightly forwards to enable the selected sling to be placed around the lower back of the patient (see Fig. 23). Position the sling around the patient’s back so that the bottom edge of the sling is level with the base of the spine. Ensure the patient’s arms are outside the sling and that the support strap is separated. Bring the support strap around the body and fasten securely by overlapping and pressing the hook and loop straps together. The strap should be tight but comfortable for the patient.

Note: *The support strap will assist in supporting the patient in the sling during the lifting procedure.*

Take each leg section of the sling in turn and slide under each leg (See Fig. 25).

Pull up each leg section strap and connect to each corresponding body strap, by connecting both halves of the buckles securely (see Fig. 34).

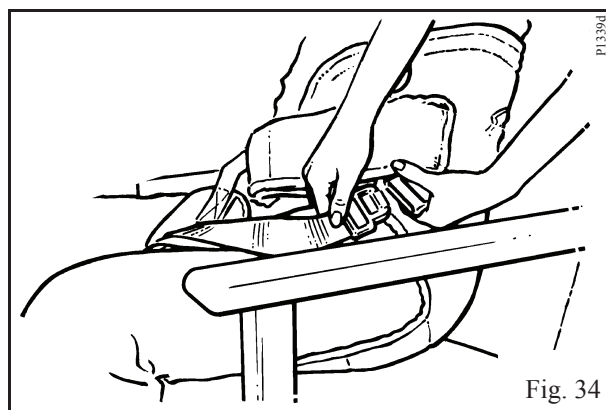

Fig. 34

Adjust the straps to be supportive but not restrictive for the patient. (See Fig. 35).

Note: *The leg section strap connection can be performed after the patient has been lifted if preferred.*

Using your Sara Plus

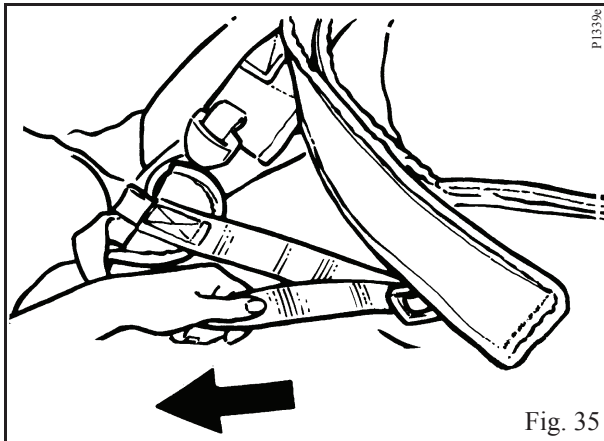

Fig. 35

Adjust the height of the Arc-Rest to be as low as possible, making allowances for obstructions, e.g. Chair arms etc.

Approach the patient from the front with the lift; stop before the Proactive Pad is in contact with the patient. (See Fig. 36).

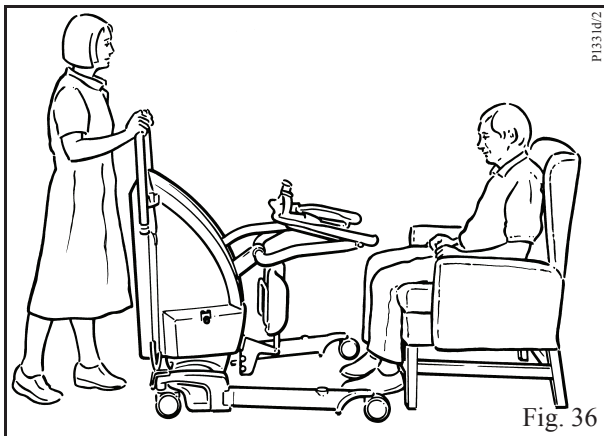

Fig. 36

Note: If required, the chassis legs may be opened to go around the chair, by operating the appropriate button on the hand control or dual control on the lift.

Note: If the handset button or dual control button is released during any function, powered motion will stop immediately.

Adjust the Proactive Pad height (if necessary) - an approximate guide is to align the top of the Proactive Pad just below the patient's patella. (See Fig. 28).

Carefully push the lift in closer to make full lower leg contact with the Proactive Pad, then apply the chassis brakes.

Identify the cord attachment loop on each side of the sling body and attach the cords (Loop Lock method as previously shown in Fig. 18). When both cords are attached correctly adjust both cords equally so that the slack is taken up, but does not pull the patient forward.



Warning: Lock the adjustment cords down into the cord retaining cleats. (See Fig. 37).

Detail view showing cords & cleats

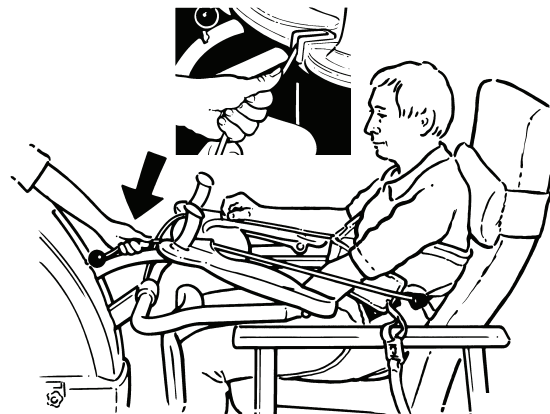

Fig. 37

Allow the patient to hold the handgrips with their arms resting on the Arc-Rest.

Slacken the adjustment on each body support strap (if required), enough to be able to connect the attachment clips to the lugs on the outer sides of the Arc-Rest (See Fig. 38).

Detail view of strap attachment

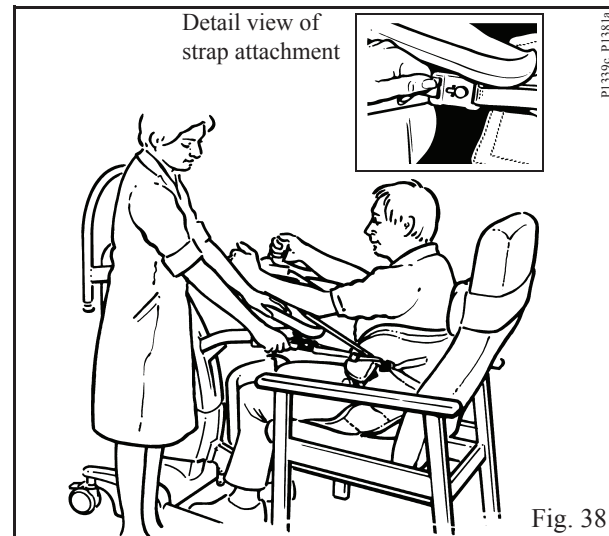

Fig. 38

When the patient is ready, operate the lift button on the handset or dual control to raise the patient, at the same time encourage him/her to actively stand (See Fig. 39).

Using your Sara Plus

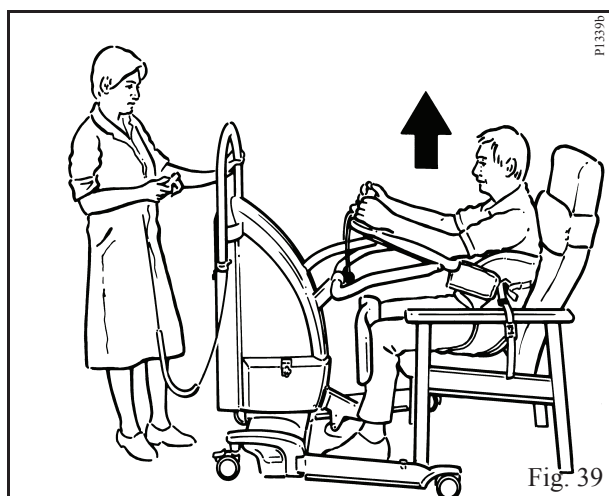

Fig. 39

Continue to raise the Arc-Rest until the patient is in a comfortably supported standing position (see Fig. 40).

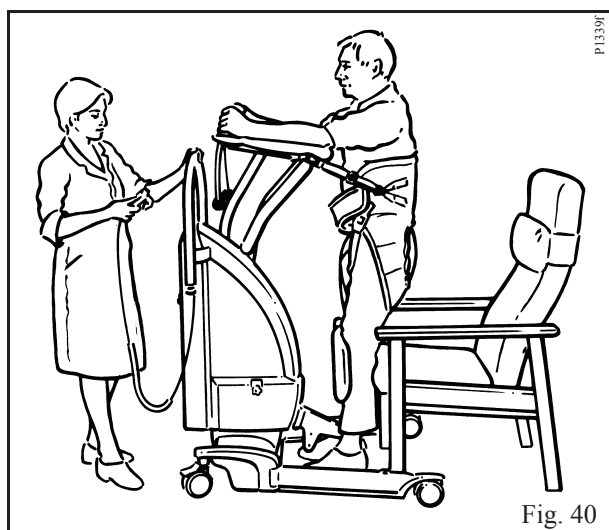

Fig. 40

If walking practice is to be carried out ensure the patient is correctly and comfortably supported, adjust the body support straps equally to take up any slack and be supportive but not too tight and make adjustment to the Arc-Rest as necessary.

When the patient is standing confidently release the brakes and pull the lift slightly away from the patient until the Proactive Pad is clear of the patients legs (see Fig. 41).

Re-apply the chassis brakes then carefully remove the Proactive Pad complete with attachment bracket by lifting upwards and store carefully for future use. (See Fig. 42).

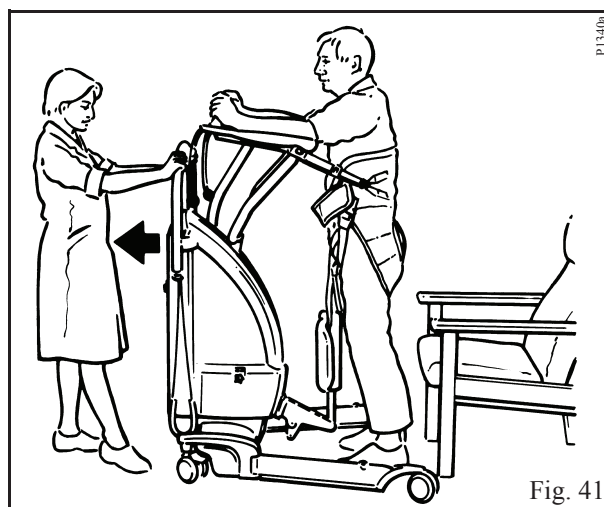

Fig. 41



Warning: When the Pro-Active pad assembly is removed, ensure that the attachment bracket is also removed before starting therapy. Failure to do so could lead to serious injury.

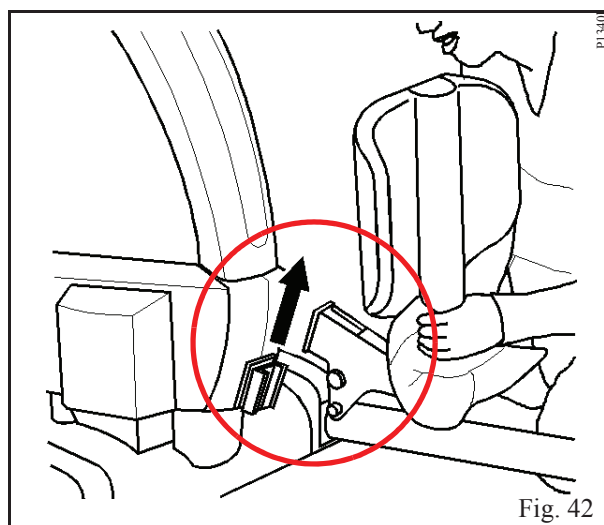

Fig. 42

Note: The chassis legs may be opened or left open to give better clearance for the patient.

Note: The 'straight line' steering lock (if fitted) can be applied over the rear castor as an additional aid if required.

With the Pro-Active pad removed and the brakes released, the patient will be able to walk at their own pace, while being supported by the Sara Plus. (See Fig. 43).

Using your *Sara Plus*

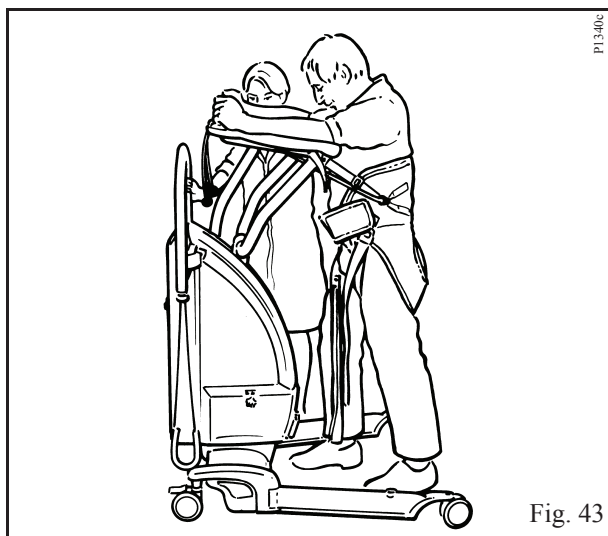

Arjo Scale (if fitted)

If your *Sara Plus* has been supplied with the integral Scale unit, it is possible to weigh a patient during the lifting procedure.

Scale (optional):- To use the scale, if available, refer to the *Scale IFU*.

Note: To have better flexion for the leg it may be necessary to slacken the leg straps slightly, this will allow better leg movement.



Warning: Do not separate the two halves of the buckles or release the adjustment cords at any stage other than when the patient is seated and fully supported.

Ensure there are no obstructions in the path before the patient is encouraged to walk.

Once walking practice has been completed, apply the chassis brakes and replace the Pro-Active pad, return the patient to a chair and when fully supported, remove the sling by reversing the fitting procedure.



Warning: When refitting the Pro-Active pad, ensure the pad is reinserted, re-tightened, and covers the support bracket. Failure to do so could lead to serious injury.

Battery Charging



Warning: The charging of the battery must only be performed away from the patient environment.

The charger is for indoor use only.

Only use the charger unit in a dry environment, do not use it in the bathroom.

Do not expose the charger unit or battery pack to rain or spray and do not immerse in water.

Do not expose the charger unit to dust.

To avoid overheating, the charger must not be covered whilst in use.

No smoking or naked flames in battery vicinity.

The battery charger is for use only with Arjo supplied batteries that are to be used with the *Sara Plus*.

The battery charger is for use with sealed lead acid batteries only.

Under no circumstances should the charger be used to attempt to charge non-rechargeable batteries.

Do not attempt to open or tamper with the charger unit in any way, for any repair the charger must be sent to the manufacturer.

The mains electricity socket must be easily accessible. Should a faulty condition occur switch off and remove the connection plug from the socket.

Only use Arjo components that have been specifically designed for the purpose when charging batteries

Only use the Arjo battery that is supplied to be used with the *Sara Plus*.

Only use the Arjo charger unit supplied with the *Sara Plus*.

Do **NOT** place batteries near, or dispose of, in a fire.

Do **NOT** short circuit a battery.

Do **NOT** store batteries at temperatures in excess of 60°C (140°F).

A battery that is charged for the first time, or after a long storage period, must be charged until the charger indicates full charge.



Warning: Do **NOT** crush, puncture, open, dismantle or otherwise mechanically interfere with batteries.

Should the battery casing become cracked, and electrolyte come into contact with skin or clothing, wash immediately with water.

Should the battery casing become cracked, and electrolyte come into contact with skin or clothing, wash immediately with water.

If the electrolyte contacts the eyes, wash immediately with copious amounts of water, and seek medical attention.

When disposing of batteries, contact the appropriate local authority for advice.

The abbreviation “Pb” shown adjacent to the recycling and trash bin symbols on the battery back label is the element symbol for lead, and indicates that the battery contains lead and therefore should not be disposed of in the normal manner but must be recycled.

Note: *Ensure the battery is removed from the lift if it is anticipated it will not be used for a prolonged period of time.*

Battery discharge indicator

The *Sara Plus* incorporates a Battery Discharge Indicator, situated on the right hand side of the cover (see Fig. 1). The display shows eight levels of battery state ranging from fully charged on the right to very low on the left (filled segment to empty segment).

Note: *The battery discharge indicator has an energy saving function, automatically switching off the display if a function button has not been operated for at least 60 seconds. The moment a button is pressed to operate any function, the display will re-start.*

It is recommended that the battery is removed from the lift and charged when the display reaches the 3 filled segments and the buzzer beeps once every 10 seconds. Lifting is possible until the display shows one filled segment and the buzzer beeps continuously. At this point, the battery must be charged as soon as possible.

Battery Charging

Recharging the battery pack before it reaches a low state of battery charge or certainly totally discharged will prolong its life. Battery Charging

To ensure the *Sara Plus* is always ready for use, it is recommended that a freshly charged battery pack is always available. This is achieved by having additional battery packs available and keeping one on charge while the other is in use.

It may be considered good protocol to have a freshly charged battery ready for the start of every work shift.

The battery life is variable (2-5 years) and mainly depends on proper charging practices. To extend the battery life, the battery must be charged at regular intervals until the charger indicates full charge. This can be done overnight.

When the battery discharge indicator displays 3 filled segments complete your lift cycle and remove the battery pack. Hold the grip of the battery and press the release catch above. Pivot the battery away and lift clear.



Warning: Hold the pack firmly to ensure it does not drop and become damaged, or cause personal injury.

Place the battery pack on charge as follows:

Note: *The cable that connects the main electricity supply to the charger is supplied as a detachable item. If using the battery charger for the first time or if the cable has been unplugged from the charger, connect the cable fully into the charger before connecting to the mains electrical socket.*



Warning: Always ensure the cable connection plugs that fit into the charger and into the battery are fully inserted before switching on mains electricity.

Take the battery to the battery charger unit and ensure the battery is positioned securely then insert the battery connector from the charger into the corresponding connector in the back of the battery, switch on mains power. An orange light will be displayed on the charger unit when the battery is totally discharged. This will change to a yellow light as the battery approaches full charge capacity, finally changing to a green light when the battery is fully charged.

Note: *The battery pack may be left connected to the charger unit when it is fully charged without being damaged by overcharging, this will also ensure the battery is kept fully charged.*

A discharged battery should be charged until the charger indicates full charge.

When the battery pack is fully charged, remove the battery pack from the charger and insert it back into the *Sara Plus*.

Ensure the green reset button (situated on the rear of the mast) is pressed in (see Fig. 1).

The *Sara Plus* is now ready for use.



Caution: Turn off the hoist after use by pressing the red Power off button (see Fig. 1). This will reduce power consumption.

Care and Preventive Maintenance

General Lift Care

How often the following actions are taken depends on how often the equipment is used.

Unless otherwise stated, it is a good idea to begin once a week and then rely on experience to decide how often it is necessary in the future.



Warning: The slings should be checked, and if necessary washed according to instructions on the sling, also refer to sling instruction sheet MAX.01520.INT.

The Polyester fleece sling cover may be removed from the sling cushion assembly for laundering. To remove the cover, undo the tie cords at each end of the sling, open up the hook and loop strap seam and remove. Secure the tie cords with a knot before laundering.



Warning: With regard to laundering, slings should not be classified as linen, but as an accessory to a patient transfer lift and therefore classified as a medical device. Slings should be cleaned and disinfected only in strict accordance with the manufacturers instructions.

Arjo strongly recommends that the support strap is removed from the sling prior to washing, this is to prevent hook and loop strap, hook damage to the fabric of the sling. The support strap should be washed separately with the hook and loop strap patches in the 'closed' position i.e.: fold the strap, over on itself and press hook and loop strap mating halves together. Always ensure the support strap is reconnected to the sling before use.

Mechanical pressure should be avoided during the washing and drying procedure e.g. rolling or pressing, as these can damage parts vital to the safe and comfortable operation of the sling.

It is recommended that Arjo Patient lifts, equipment, accessories and slings are regularly cleaned. If the slings, lifts and equipment needs cleaning, or are suspected of being contaminated, follow the cleaning and/or disinfection procedures recommended below, before re-using the equipment. This is especially important when using the same equipment for another patient, to minimise the risk of cross infection.

For cleaning your lift, equipment and accessories

wipe down with a damp cloth using warm water to which a disinfectant/cleaner has been added e.g. "ARJO CLEAN" - disinfectant/cleaner or equivalent. Take extra care with areas that may trap dust or dirt.



Warning: The lift should be cleaned before it is used by another patient.

Note: ARJO CLEAN - disinfectant cleaner is available from Arjo or their approved distributors.



Caution: Do not over wet areas of the product which could cause problems with electrical components or internal corrosion.

If a hot air dryer is used to dry the lift, the temperature must not exceed 80°C (176°F).

Do not use petroleum based solvents or similar, since this may damage plastic parts.



Warning: For disinfection of contaminated lifts, equipment and accessories, use the preferred method of wiping the product completely with "hard surface disinfectant wipes" that are supplied impregnated with a 70% v/v solution of Isopropyl Alcohol.

Note: A rubbing action will be necessary when using the wipes to promote effective disinfection of the surfaces.



Warning: IMPORTANT: Cleaning and disinfection products must be used in accordance with the manufacturers instructions and suitable eye, hand and clothing protection must be worn at all times when handling disinfectants.

Note: 70% v/v Isopropyl Alcohol wipes have been proved to be effective against MRSA and several other micro-organisms under light soiling conditions.

Note: Check that the lift can be propelled in a normal manner, making sure that the castors roll and swivel freely. Clean with water. (the function can be affected by soap, hair, dust and chemicals from floor cleaning).

Ensure that the battery pack is always in a good state of charge.

Care and Preventive Maintenance

The *Sara Plus* is subject to wear and tear, and the following actions must be performed when specified to ensure that the product remains within its original manufacturing specification.

Warning

The points on this checklist are the minimum the manufacturer recommends. In some cases due to heavy use of the product and exposure to aggressive environment, more frequent inspections shall be carried out. Continuing to use this product without conducting regular inspections or when a fault is found will seriously compromise the user and residents' safety. Local regulations and standards may be higher than the manufacturers. Preventive maintenance specified in this manual can prevent accidents.

Note:

Product cannot be maintained and serviced while in use with the patient.

Preventive Maintenance Schedule

Action/Check	Before each use	Every week	Every 12 months
CAREGIVER OBLIGATIONS			
Examine the sling, straps and clips for damage or fraying as required. Refer to sling documentation.	X		S
Visually check exposed surfaces for damage, sharp edges, etc.		X	
Visually check sling attachment points. Do not use if damaged.		X	
Make sure all labels are attached.		X	
Check to make sure the hand grips are secure. Re-bond if required.	X		S
Examine the charger and wires for integrity and connections.			S
Operate the <i>Sara Plus</i> through its full range.		X	
Visually check the handset and cable for damage.		X	
Perform a full function test on the <i>Sara Plus</i> .		X	S
Check operation of the Stop/Reset and System Lower Override Device.		X	S
Check batteries for leakage and/or deterioration. Replace if required.		X	S
Make sure all fixings, screws, nuts are secure and tight.		X	S
Check and clean all castors. Replace as required.		X	S
Check that the covers fit correctly and are not damaged. Replace as required.		X	S
Check for evidence of corrosion. Replace as necessary.		X	S

Warning

The actions marked with 'S' must be carried out by qualified personnel, using correct tools and knowledge of procedures referring to the *Service Manual*. Failure to meet these requirements could result in personal injuries and/or unsafe product.

Care and Preventive Maintenance

Before each and every use

Make sure the battery is charged before use. If not adequately charged, replace with a fully charged battery.

Where necessary, after each patient use, carry out decontamination of the *Sara Plus* in accordance with this IFU, and local regulations.

Daily

Make sure the battery pack is in a good state of charge. Charge the battery at the end of each working shift, or as soon as possible if the Battery Discharge Indicator displays this and gives a audible warning. See *Battery charging* in this IFU.

Make sure the Lower Override knob is turned fully clockwise and is finger tight (do not over tighten).

Make sure that the sling attachment cords and the loop lock assembly are visually inspected. Any component found frayed or damaged must be replaced with a new loop lock assembly.

Weekly

For longevity regularly charge battery/s until the charger indicates full charge. See *Battery charging* in this IFU.

General Lift Condition

A general visual inspection of all external parts should be carried out, and all functions should be tested for correct operation, to ensure that no adverse damage has occurred during use.

- Make sure all castors rotate freely and the two rear brakes lock. Where installed, make sure the Straight Line Steering Guide locks the rear castor in line.
- Make sure the castor-mounting pin is tight on the chassis and chassis legs and the castor tread is not damaged
- Open and close the chassis legs and check for full travel and smooth movement.
- Examine the condition of the handset and its cable. Replace if damaged.
- Make sure all external fittings are secure, and all screws and nuts are tight.
- Make sure the handgrips are secure, tighten if required.
- Examine the integrity of the loop lock assemblies and the knot within the cone knob.
- Make sure the screw retaining the front clevis pin in the upper lift arm is tightened.
- Make sure the screws retaining the cord cleats in

the Arc-Rest are tight.

- Make sure all instruction labels are firmly attached and are readable.
- Examine all exposed parts, especially where there is personal contact with the patient's body. Make sure no cracks or sharp edges have developed that could cause patient or caregiver injury or have become unhygienic. Replace where necessary
- Make sure the foot support can be removed and replaced and there is no damage to the hook and location pins on the Foot Bracket assembly.

Automatic Stop Function

With the Patient Support arms raised well above its lowest position, lower it, and at the same time hold the Patient Support arms up briefly. The motor will continue to run while the Patient Support arms weight is held. This check is for the correct function of the automatic stop.

Emergency Stop

Test the emergency stop by operating the patient support arms. Press in the emergency stop button. (See Fig. 1). The movement should stop immediately.



Warning: If in any doubt about the correct functioning of the *Sara Plus*, withdraw it from use and contact Arjo Service Department.

Care and Preventive Maintenance

Cleaning and Disinfecting the Toilet Commode Chair and Frame (if fitted)

For exterior areas of the seat and frame the “hard surface disinfectant wipes” mentioned above will be very effective, but for internal and crevice areas of the equipment Arjo recommend that the seat and frame is cleaned in accordance with your normal cleaning and disinfecting protocol.

Disassembly of the Commode Seat

Remove the plastic commode seat from the seat frame by pulling the rear edge up sharply to disengage the locating lugs (see Fig. 47). Slide the seat forwards a short distance until clear of the frame tubes and lift away

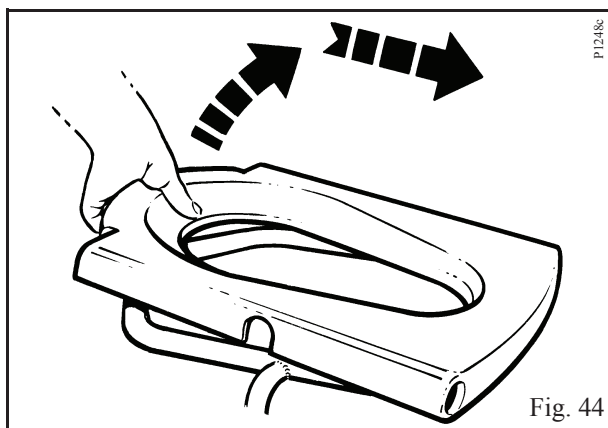

To refit the commode seat, locate the seat holes over the seat frame tubes, and align the location lugs over the rear cross bar of the seat frame as shown in Fig. 48. Apply sharp downward blows onto the rear of the seat, (as shown in Fig. 49), in two places directly above the location lugs, until the seat ‘snaps’ back into place.

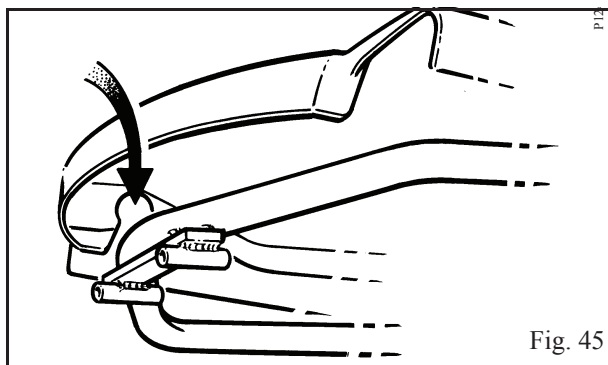

Warning: Always ensure the seat is secure before allowing a patient to use it.

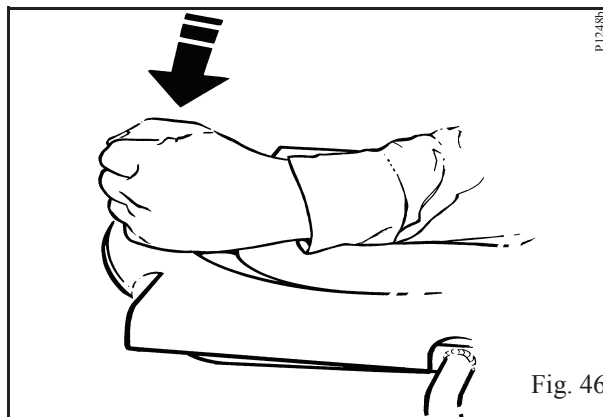

Care and Preventive Maintenance

Servicing Advice



Warning: Arjo recommend that the *Sara Plus* is maintained at regular intervals, see Preventative maintenance schedule in this document



Warning: UK LIFTS ONLY: Important legislation came into force on 5th December 1998, which has an impact on the schedule of service for your patient lift(s), variable height baths and other raising and lowering equipment. The Lifting Operations and Lifting Equipment Regulations (LOLER) 1998 and The Provision and Use of Work Equipment Regulations (PUWER 98) must be satisfied by the duty holder. A scheme of six monthly thorough examinations has been devised to comply with the law and details can be obtained from Arjo Service UK

Parts lists and circuit diagrams are available from Arjo or their approved distributors.

Spare parts, if required are available from Arjo or their approved distributors.

Special tools are required for certain component replacement.

Environmental Advice

This device is marked with the WEEE symbol (crossed-out wheeled bin) to indicate that it is electronic equipment covered by the Directive 2002/96/EC on waste electrical and electronic equipment. This is a European directive but applies worldwide. In European countries the WEEE symbol reminds you that all electrical and electronic products must be taken to a separate collection at the end of their working life. Do not dispose of this product in normal domestic or commercial waste - contact your local authority for advice on disposal.





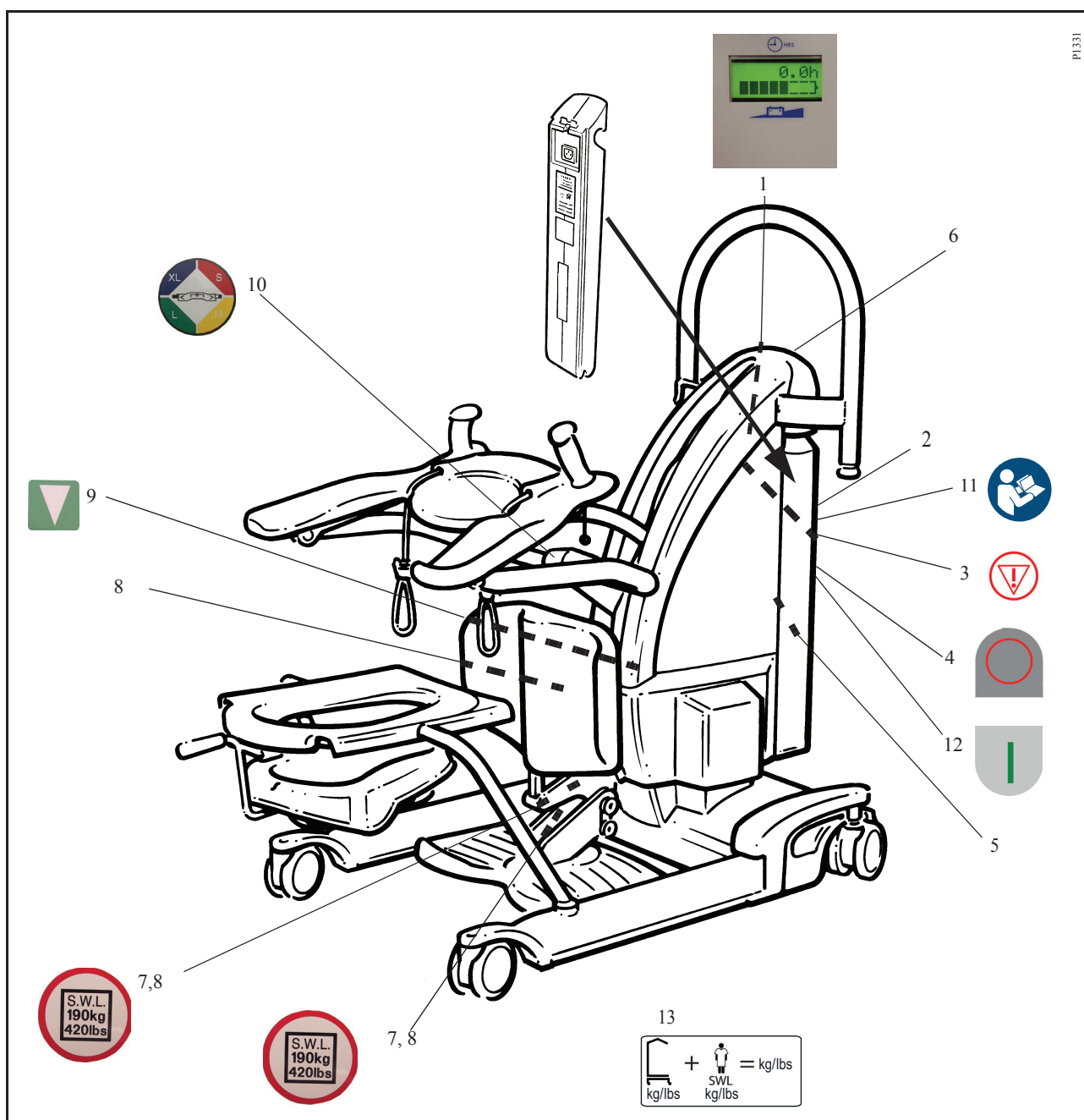





Labels



P1331

- | | |
|---|---|
| <ol style="list-style-type: none"> 1. Label - Battery discharge indicator and Cycle/ Hour meter 2. Label - Arjo logo 3. Label - Emergency stop button identification 4. Label - Power Off Button identification 5. Label - Address and SWL 190 kg (420 lbs) 6. Label - “Sara Plus” 7. Label - Safe working load 190 kg (420 lbs) 8. Label - CE mark | <ol style="list-style-type: none"> 9. Label - System failure lower override identification 10. Label - Sling size guide 11. Label - Read operating instructions before use 12. Label - Power On/Reset button identification 13. Label - Maximum total weight of lift |
|---|---|

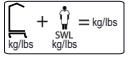
Labels

Symbol Explanation	
	Mandatory to read the Instructions for Use
	A battery is the power source of this equipment.
	Separate electrical and electronic components for recycling in accordance with the European Directive 2012/19/EU (WEEE)
	Recyclable
IP 24	Degree of protection (i.e. the product is protected against insertion of fingers and splashing water
	Type BF Applied part: protection against electrical shock in accordance with EN/IEC 60601-1.
	CE marking indicating conformity with European Community harmonised legislation Figures indicate Notified Body supervision.
	Indicates the product is a Medical Device according to EU Medical Device Regulation 2017/745
	Total mass of equipment including its safe working load.
	Name and address of the manufacturer
	Manufacturing date

Technical Specification

	kg	lbs
Safe Working Load	190	(420)
Maximum weight limit to be lifted or carried (when using 'standing sling')	190	(420)
Maximum weight limit to be lifted or carried (when using 'transfer and walking sling' for walking practice only)	190	(420)
Maximum weight limit to be lifted or carried (when using the 'transfer and walking sling' for transfer operation only)	140	(308)
Maximum weight limit to be carried (when using 'toilet commode seat and frame')	190	(420)

Component Weights

	kg	(lbs)
<i>Sara Plus</i> - non-scale version (complete - without battery)	73.8	(162.7)
<i>Sara Plus</i> - scale version (complete - without battery).....	82.9	(182.8)
<i>Sara Plus</i> - scale version (complete - with scale and battery)	88	(194)
Maximum total weight of lift (lift + patient)	278	(614)
Battery pack	4.9	(10.8)
Commode seat and frame (option).....	4	(8.8)
Commode pan and holder (option)	1.2	(2.6)
Foot support	5	(11)

All slings - check the safe working load on the sling label

Electrical

Battery type and part number	(Rechargeable - lead acid): SPL3021
Battery capacity:	6 Ah
Battery charger part number:	SPL3024**
(Note:** indicates relevant country code)	
Fuse	15 A (Thermal overcurrent circuit breaker)
Fuse – PCBA	20 A
Fuse – battery	30 A
Protection class lift.	IP 24
Protection class hand control	IP X7
Lift nominal voltage:	24 V DC
Operating force of controls	< 5 N

Medical Equipment:- type BF  protection against electrical shock in accordance with IEC 60601-1
 Arjo patient handling products meet the requirements of Electromagnetic Compatibility (EMC) as stated in clause 12.5 of the Medical Devices Directive 93/42/EEC



Although compliant with EMC requirements there is a remote chance that close proximity usage may affect over-sensitive electrical equipment

The symbol IP n₁n₂ indicates the degree of ingress protection against solid particles (n₁) and liquids (n₂).
 2: Protection against solid particle ingress larger than 12.5 mm - fingers or similar objects.
 4: Protection against liquid ingress - water splashing against the enclosure from any direction shall have no harmful effect.

Conforms to IEC 60601-1:2012(ed.3.1), ANSI/AAMI ES60601-1:2005 / A2:2010, CAN/CSA-C22.2 No. 60601-1:08 and ISO 10535:2006.

	Duty cycle	Max volts	Max amps
Mast Lift Actuator (sealed electro-hydraulic unit)	10% (2 min/18 min)	24 V	20 A
'V' Chassis Actuator (electro-mechanical unit)	10% (2 min/18 min)	24 V	8 A

Technical Specification

Maximum sound power level

In accordance with ISO 3746 74 dB
(dB re 1pW ± 3dB)

Environment

Operating, transport and storage

Temperature	+10 °C to + 40 °C (+50 °F to +104 °F) Operation -20 °C to +70 °C (-4 °F to +158 °F) Transport -20 °C to +70 °C (-4 °F to 158 °F) Storage
Relative humidity range	30% to 75% Operation 10% to 80% including condensation Transport and Storage
Atmospheric pressure	800 hPa to 1060 hPa Operating 500 hPa to 1100 hPa Transport 500 hPa to 1100 hPa Storage

End of Life Disposal

- All batteries in the product must be recycled separately. Batteries are to be disposed in accordance with national or local regulations.
- Slings including stiffeners/stabilizers, padding material, any other textiles or polymers or plastic materials etc. should be sorted as combustible waste.
- Lift systems having electrical and electronic components or an electrical cord should be disassembled and recycled per Waste of Electrical and Electronic Equipment (WEEE) or in accordance with local or national regulation.
- Components that are primarily be made up of different kinds of metal (containing more than 90% metal by weight) for example sling bars, rails, upright supports, etc., should be recycled as metals.

Technical Specification

Sara Plus Dimensions

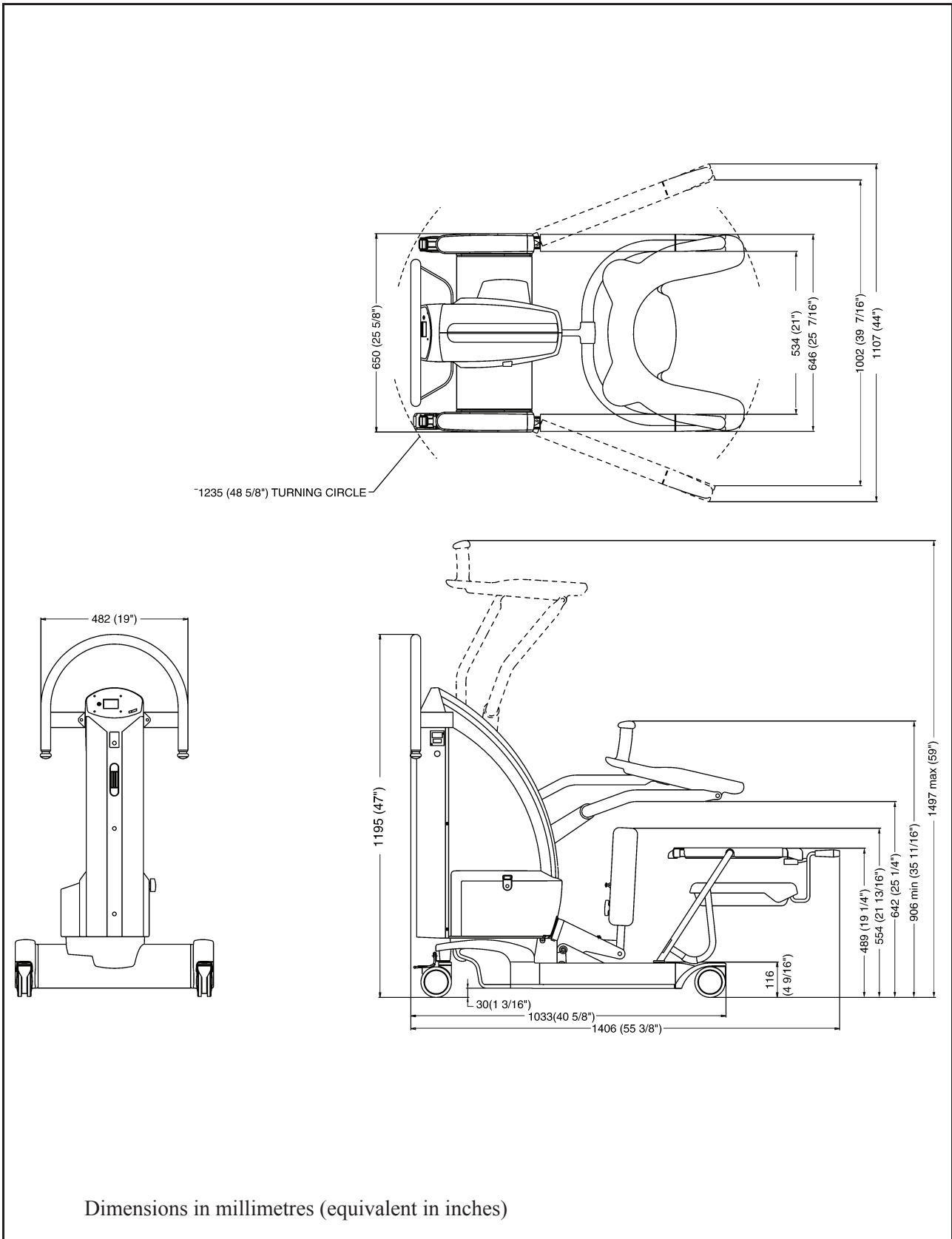

Troubleshooting

Problem description	Probable cause	Solution
The <i>Sara Plus</i> is brand new and not functioning at all.	Power Off button (red) is still engaged.	Press the green Reset/Power On button to disengage the Power Off button.
The <i>Sara Plus</i> is raising and lowering more slowly than usual.	Low battery power level.	Check the Battery Discharge Indicator (on the mast of the <i>Sara Plus</i> , just above the battery). This indicates the power level of the battery. If in doubt, replace the battery with a fully charged one and compare the performance. In case of low battery power level, replace the battery on the <i>Sara Plus</i> with a fully charged one.
The <i>Sara Plus</i> does not raise or lower and the chassis legs cannot be opened or closed when using the hand control.	Hand control is damaged	Try operating the <i>Sara Plus</i> with the Dual Up/Down control located on the mast. If the equipment functions correctly when using these controls, the hand control should be replaced.
The <i>Sara Plus</i> does not raise or lower and the chassis legs cannot be opened or closed when using either the hand control or the Dual Up/Down controls.	Control electronics or actuator malfunction	Contact your Arjo dealer or an Arjo approved service engineer.
When the “Raise” button is pressed, the <i>Sara Plus</i> makes a noise, “overload” is displayed on the Hour/Cycle Meter and buzzer beeps continuously but the resident support arms do not move upwards.	The resident support arms are blocked by an obstruction	Remove the obstruction and check the <i>Sara Plus</i> thoroughly for damage before continuing the lifting cycle. If in doubt, use the System Failure Lower Override to return the resident to a safe seated position, then remove the <i>Sara Plus</i> from use. Do not use the equipment again until it has been inspected and passed for safe working by an Arjo approved service engineer.
When the “Chassis Legs Open” button is pressed, the <i>Sara Plus</i> makes a noise, “overload” is displayed on the Hour/Cycle Meter and the buzzer beeps continuously but the chassis legs do not open.	The chassis legs are blocked by an obstruction.	Remove the obstruction and check the <i>Sara Plus</i> thoroughly for damage before continuing the lifting cycle. If in doubt, use the System Failure Lower Override to return the resident to a safe seated position, then remove the <i>Sara Plus</i> from use. Do not use the equipment again until it has been inspected and passed for safe working by an Arjo approved service engineer.
Unexpected movement of hoist	Faulty hand control, push buttons or electronics.	If releasing the buttons does not work: Push the red Emergency Stop button and remove the battery from the hoist. Use the System Failure Lowering Override to put the patient back into a safe seated position, then remove the <i>Sara Plus</i> from use. Do not use the equipment again until it has been inspected and passed for safe working by an Arjo approved service engineer.
“OverHeat” is displayed and the buzzer beeps twice every 15 seconds.	The actuator duty cycle is exceeded (2 minutes ON/ 18 minutes OFF).	Finish the operation and wait 18 minutes. This prevents the actuator from damage.

Electromagnetic Compatibility

Product has been tested for compliance with current regulatory standards regarding its capacity to block EMI (electromagnetic interference) from external sources.

Some procedures can help reduce electromagnetic interferences:

- Use only Arjo cables and spare parts to avoid increased emissions or decreased immunity which can compromise the correct functioning of the equipment.
- Ensure that other devices in patient-monitoring and/or life-support areas comply to accepted emissions standards.

Warning: Wireless communications equipment such as wireless computer network devices, mobile phones, cordless telephones and their base stations, walkie-talkies, etc. can affect this equipment and should be kept at least 1.5 m away from the equipment.

Intended Environment: Home Healthcare Environment and Professional Healthcare facility environment.

Exceptions: HF Surgical Equipment and the RF Shielded room of an ME SYSTEM for magnetic resonance imaging.

Warning: Use of this equipment adjacent to or stacked with other equipment should be avoided because it could result in improper operation. If such use is necessary, this equipment and the other equipment should be observed to verify that they are operating normally.

Guidance and manufacturer's declaration – electromagnetic emission		
Emission test	Compliance	Guidance
RF emissions CISPR 11	Group 1	This equipment uses RF energy only for its internal functions. Therefore its RF emissions are very low and are not likely to cause any interference in nearby electronic equipment.
RF emissions CISPR 11	Class B	This equipment is suitable for use in all establishments, including domestic establishments and those directly connected to the public low voltage power supply network that supplies buildings used for domestic purposes.

Guidance and manufacturer's declaration – electromagnetic immunity			
Immunity test	IEC 60601-1-2 test level	Compliance level	Electromagnetic environment – guidance
Electrostatic discharge (ESD)	±2kV, ±4kV, ±8kV, ±15kV air	±2kV, ±4kV, ±8kV, ±15kV air	Floors should be wood, concrete or ceramic tile. If floors are covered with synthetic material, the relative humidity should be at least 30%.
EN 61000-4-2	±8kV contact	±8kV contact	

Electromagnetic Compatibility

Conducted disturbances induced by RF fields EN 61000-4-6	3V in 0,15 MHz to 80 MHz 6V in ISM and amateur radio bands between 0,15 MHz and 80 MHz 80% AM at 1 kHz	3V in 0,15 MHz to 80 MHz 6V in ISM and amateur radio bands between 0,15 MHz and 80 MHz 80% AM at 1 kHz	Portable and mobile RF communications equipment should be used no closer to any part of the product, including cables, than 1.0m, if the transmitter's output power rating exceeds 1W ^a . Field strengths from fixed RF transmitters, as determined by an electromagnetic site survey, should be less than the compliance level in each frequency range ^b . Interference may occur in the vicinity of equipment marked with this symbol: 
Radiated RF electromagnetic field EN 61000-4-3	Home Healthcare environment 10 V/m 80 MHz to 2,7 GHz 80% AM at 1 kHz	Home Healthcare environment 10 V/m 80 MHz to 2,7 GHz 80% AM at 1 kHz	
Proximity fields from RF wireless communications equipment EN 61000-4-3	385 MHz - 27 V/m 450 MHz - 28 V/m 710, 745, 780 MHz - 9V/m 810, 870, 930 MHz - 28 V/m 1720, 1845, 1970, 2450 MHz – 28 V/m 5240,5500, 5785 MHz - 9V/m	385 MHz - 27 V/m 450 MHz - 28 V/m 710, 745, 780 MHz - 9V/m 810, 870, 930 MHz - 28 V/m 1720, 1845, 1970, 2450 MHz – 28 V/m 5240,5500, 5785 MHz - 9V/m	
Electrical fast transient/burst EN 61000-4-4	±1kV SIP/SOP ports 100 kHz repetition frequency	±1kV SIP/SOP ports 100 kHz repetition frequency	
Power frequency Magnetic field EN 61000-4-8	30 A/m 50 Hz or 60 Hz	30 A/m 50 Hz	Power frequency magnetic fields should be at levels characteristic of a typical location in a typical commercial or hospital environment.

^a Field strengths from fixed transmitters, such as base stations for radio (cellular/cordless) telephones and land mobile radios, amateur radio, AM and FM radio broadcast and TV broadcast cannot be predicted theoretically with accuracy. To assess the electromagnetic environment due to fixed RF transmitters, an electromagnetic site survey should be considered. If the measured field strength in the location in which the product is used exceeds the applicable RF compliance level above, the product should be observed to verify normal operation. If abnormal performance is observed, additional measures may be necessary.

^b Over the frequency range 150 kHz to 80 MHz, field strengths should be less than 1 V/m.

! **Caution:** Operating the product near a strong electro-magnetic field may affect the displayed weight measurement.
These changes does not affect user safety.

Intentionally left blank

AUSTRALIA

Arjo Australia Pty Ltd
78, Forsyth Street
O'Connor
AU-6163 Western Australia
Tel: +61 89337 4111
Free: +1 800 072 040
Fax: + 61 89337 9077

BELGIQUE / BELGIË

Arjo NV/SA
Evenbroekveld 16
BE-9420 ERPE-MERE
Tél/Tel: +32 (0) 53 60 73 80
Fax: +32 (0) 53 60 73 81
E-mail: info.belgium@arjo.com

BRASIL

Arjo Brasil Equipamentos Médicos Ltda
Rua Marina Ciufuli Zanfelice, 329 PB02 Galpão
- Lapa
São Paulo – SP – Brasil
CEP: 05040-000
Phone: 55-11-3588-5088
E-mail: vendas.latam@arjo.com
E-mail: servicios.latam@arjo.com

CANADA

Arjo Canada Inc.
90 Matheson Boulevard West
Suite 300
CA-MISSISSAUGA, ON, L5R 3R3
Tel/Tél: +1 905 238 7880
Free: +1 800 665 4831 Institutional
Free: +1 800 868 0441 Home Care
Fax: +1 905 238 7881
E-mail: info.canada@arjo.com

ČESKÁ REPUBLIKA

Arjo Czech Republic s.r.o.
Na Strži 1702/65
140 00 Praha
Czech Republic
Phone No: +420225092307
e-mail: info.cz@arjo.com

DANMARK

Arjo A/S
Vassingerødvej 52
DK-3540 LYNGE
Tel: +45 49 13 84 86
Fax: +45 49 13 84 87
E-mail:
dk_kundeservice@arjo.com

DEUTSCHLAND

Arjo GmbH
Peter-Sander-Strasse 10
DE-55252 MAINZ-KASTEL
Tel: +49 (0) 6134 186 0
Fax: +49 (0) 6134 186 160
E-mail: info-de@arjo.com

ESPAÑA

Arjo Ibérica S.L.
Parque Empresarial Rivas Futura, C/Marie
Curie 5
Edificio Alfa Planta 6 oficina 6.1-.62
ES-28521 Rivas Vacia, MADRID
Tel: +34 93 583 11 20
Fax: +34 93 583 11 22
E-mail: info.es@arjo.com

FRANCE

Arjo SAS
2 Avenue Alcide de Gasperi
CS 70133
FR-59436 RONCQ CEDEX
Tél: +33 (0) 3 20 28 13 13
Fax: +33 (0) 3 20 28 13 14
E-mail: info.france@arjo.com

HONG KONG

Arjo Hong Kong Limited
Room 411-414, 4/F, Manhattan Centre,
8 Kwai Cheong Road, Kwai Chung, N.T.,
HONG KONG
Tel: +852 2960 7600
Fax: +852 2960 1711

ITALIA

Arjo Italia S.p.A.
Via Giacomo Peroni 400-402
IT-00131 ROMA
Tel: +39 (0) 6 87426211
Fax: +39 (0) 6 87426222
E-mail: Italy.promo@arjo.com

MIDDLE EAST

Arjo Middle East FZ-LLC
Office 908, 9th Floor,
HQ Building, North Tower,
Dubai Science Park,
Al Barsha South
P.O Box 11488, Dubai,
United Arab Emirates
Direct +971 487 48053
Fax +971 487 48072
Email: Info.ME@arjo.com

NEDERLAND

Arjo BV
Biezenwei 21
4004 MB TIEL
Postbus 6116
4000 HC TIEL
Tel: +31 (0) 344 64 08 00
Fax: +31 (0) 344 64 08 85
E-mail: info.nl@arjo.com

NEW ZEALAND

Arjo Ltd
34 Vestey Drive
Mount Wellington
NZ-AUCKLAND 1060
Tel: +64 (0) 9 573 5344
Free Call: 0800 000 151
Fax: +64 (0) 9 573 5384
E-mail: nz.info@Arjo.com

NORGE

Arjo Norway AS
Olaf Helset's vei 5
N-0694 OSLO
Tel: +47 22 08 00 50
Faks: +47 22 08 00 51
E-mail: no.kundeservice@arjo.com

ÖSTERREICH

Arjo GmbH
Lemböckgasse 49 / Stiege A / 4.OG
A-1230 Wien
Tel: +43 1 8 66 56
Fax: +43 1 866 56 7000

POLSKA

Arjo Polska Sp. z o.o.
ul. Ks Piotra Wawrzyniaka 2
PL-62-052 KOMORNIKI (Poznań)
Tel: +48 61 662 15 50
Fax: +48 61 662 15 90
E-mail: arjo@arjo.com

PORTUGAL

Arjo em Portugal
MAQUET Portugal, Lda.
(Distribuidor Exclusivo)
Rua Poeta Bocage n.º 2 - 2G
PT-1600-233 Lisboa
Tel: +351 214 189 815
Fax: +351 214 177 413
E-mail: Portugal@arjo.com

SUISSE / SCHWEIZ

Arjo AG
Fabrikstrasse 8
Postfach
CH-4614 HÄGENDORF
Tél/Tel: +41 (0) 61 337 97 77
Fax: +41 (0) 61 311 97 42

SUOMI

Arjo Scandinavia AB
Riihitontuntie 7 C
02200 Espoo
Finland
Puh: +358 9 6824 1260
E-mail: Asiakaspalvelu.finland@arjo.com

SVERIGE

Arjo International HQ
Hans Michelsensgatan 10
SE-211 20 MALMÖ
Tel: +46 (0) 10 494 7760
Fax: +46 (0) 10 494 7761
E-mail: kundservice@arjo.com

UNITED KINGDOM

Arjo UK and Ireland
Houghton Hall Park
Houghton Regis
UK-DUNSTABLE LU5 5XF
Tel: +44 (0) 1582 745 700
Fax: +44 (0) 1582 745 745
E-mail: sales.admin@arjo.com

USA

Arjo Inc.
2349 W Lake Street Suite 250
US-Addison, IL 60101
Tel: +1 630 307 2756
Free: +1 800 323 1245 Institutional
Free: +1 800 868 0441 Home Care
Fax: +1 630 307 6195
E-mail: us.info@arjo.com

JAPAN

Arjo Japan K.K.
東京都港区虎ノ門三丁目7番8号 ランディッ
ク第2虎ノ門ビル9階
電話 : +81 (0)3-6435-6401

Address page - REV 24: 04/2019

At Arjo, we are committed to improving the everyday lives of people affected by reduced mobility and age-related health challenges. With products and solutions that ensure ergonomic patient handling, personal hygiene, disinfection, diagnostics, and the effective prevention of pressure ulcers and venous thromboembolism, we help professionals across care environments to continually raise the standard of safe and dignified care. Everything we do, we do with people in mind.



ArjoHuntleigh AB
Hans Michelsensgatan 10
211 20 Malmö, Sweden
www.arjo.com

arjo

CE
2797