

INSTRUCTIONS FOR USE

Sara Combilizer



WARNING

To avoid injury, always read this Instructions for Use and accompanied documents before using the product.



Mandatory to read the Instructions for Use

Design Policy and Copyright

® and ™ are trademarks belonging to the Arjo group of companies.

© Arjo 2019.

As our policy is one of continuous improvement, we reserve the right to modify designs without prior notice. The content of this publication may not be copied either whole or in part without the consent of Arjo.

Content

Foreword	4
Intended Use	5
Safety Instructions	6
Preparations	7
Parts Designation	8
Product Description/Functions	10
Sara Combilizer Directions	10
Sara Combilizer Positions	11
Castor Brakes	12
Armrest	12
Foot Support	14
Shoulder Support	16
Mattresses	17
Covers for Mattresses and Pillow	20
Cover and Foam for Armrest Cushions	20
Tilt Angle Indicator	21
Fluid Bag Attachment Loops	21
Side Transport Handles	21
Battery	21
Control Functions	22
Controls	22
Modes	22
Mode Colour	23
Change of Mode	23
Mode Indication on Control Panel	23
Button Functions	24
Safety Belts	25
Emergency and Safety Functions	29
Pinch Protection Bar	29
Emergency Stop	29
Emergency Function Box	29
Operation	32
Transfer of Patient from Bed to Sara Combilizer	32
Transfer of Patient from Sara Combilizer to Bed	36
Transfer of Patient from Sitting to Standing Position	39
Transfer of Patient from Standing to Sitting Position	41
Change Position	43
Transport	46
Cleaning and Disinfection Instructions	47
Battery Instructions	54
Care and Preventive Maintenance	55
Caregiver Obligations	56
Yearly Checks by Qualified Personnel only	59
Troubleshooting and Alarms	60
Technical Specifications	62
Dimensions	66
Labels	68
List of Standards and Certificates	71
Electromagnetic Compatibility	72
Parts and Accessories	74

Foreword

Thank you for purchasing Arjo equipment.

Please contact us if you have any questions about the operation or maintenance of your Arjo equipment.

Please read and fully understand this *Instructions for Use (IFU)* before using the Sara Combilizer®.

Information in this *IFU* is necessary to perform the operation and maintenance of the equipment. It will help to protect your product and make sure that the equipment performs to your satisfaction. The information in this *IFU* is important for the safety of both the patient and caregiver and must be read and understood to help prevent possible injury.

Unauthorized modifications on any Arjo equipment can affect safety. Arjo will not be held responsible for any accidents, incidents or lack of performance that occur as a result of any unauthorized modification to its products.

Service and Support

A routine service must be performed on the *Sara Combilizer* every year by qualified personnel to maintain safety and reliability of the equipment. See section *Care and Preventive Maintenance* on page 55.

If you require further information, please contact Arjo for comprehensive support and service maintenance to maximize the long-term safety, reliability and value of the product.

Contact your local Arjo representative for replacement parts. The telephone numbers appear on the last page of this *IFU*.

If a serious incident occurs in relation to this medical device, affecting the user, or the patient then the user or patient should report the serious incident to the medical device manufacturer or the distributor. In the European Union, the user should also report the serious incident to the Competent Authority in the member state where they are located.

Definitions in this *IFU*

WARNING

Means:

Safety warning. Failure to understand and obey this warning may result in injury to you or to others.

CAUTION

Means:

Failure to follow these instructions may cause damage to all or parts of the system or equipment.

NOTE

Means:

This is important information for the correct use of this system or equipment.



Means:

The name and address of the manufacturer.

Intended Use

This equipment must be used in line with its intended use and in accordance with the safety instructions in this *Instructions for Use (IFU)*. Anyone using this equipment must also have read and understood the instructions in this *IFU*.

If there is anything that remains unclear, contact your Arjo representative.

Intended Use for *Sara Combilizer*

The *Sara Combilizer* is intended to facilitate early mobilization, rehabilitation and care of patients. It may be used for people with all levels of immobility that pass a relevant clinical assessment with regards to planned activities. This may include weak, passive and non-ambulatory patients.

The intended environments for usage are: hospitals including critical care units and long term acute care facilities and rehabilitation wards.

Sara Combilizer is intended to be used to move the patient from a supine to a standing position and move from a supine to a sitting position. In standing, sitting and lying positions, *Sara Combilizer* may be used for various rehabilitation exercises and to mobilize the patient by tilting *Sara Combilizer* sideways at regular intervals.

Sara Combilizer can be used for short distance transportation in connection with therapeutic use.

Sara Combilizer is not intended for long distance transportation from one unit to another while the patient is laying on it.

Sara Combilizer is only to be used together with belts, slide sheets and lifts as specified and in accordance with the *Instructions for Use (IFU)*.

Sara Combilizer must be used by appropriately trained caregivers with adequate medical knowledge.

Caregiver must have knowledge about common medical practices and procedures and must use *Sara Combilizer* in accordance with the guidelines specified in the *Instructions for Use*. Any other use is prohibited.

Patient Assessment

It is recommended that facilities establish regular assessment routines. Caregivers should assess each patient according to the following criteria prior to use:

- *Sara Combilizer* may only be used with patients that have passed a clinical assessment performed by a professional with relevant medical competence.
- *Sara Combilizer* is intended to facilitate patients' rehabilitation activities, for patients tolerating an upright and/or sitting position, including weak, passive and non-ambulatory patients.
- The patient's weight must not exceed 200 kg (440 lbs).
- The patient's height must be in the range of 140 cm (4'7") and 196 cm (6'5").

If the patient does not meet the above criteria an alternative piece of equipment or system should be utilized.

Contraindications

The *Sara Combilizer* may not be used if the patient does not pass a clinical assessment, performed by a professional with relevant medical competence.

Service Requirements & Expected Lifetime

The expected lifetime of this equipment, unless otherwise stated, is ten (10) years if preventive maintenance is being carried out in accordance with the instruction for *Care and Preventive Maintenance* found in this *IFU*.

Safety Instructions

WARNING

To avoid injury, make sure that the patient is not left unattended at any time.

WARNING

To avoid falling during transfer, always make sure that the brakes are applied on all equipment being used.

WARNING

To avoid falling, make sure that the patient is positioned correctly and that the safety belts are being used, properly fastened and tightened.

WARNING

To avoid falling, make sure that the user weight is lower than the safe working load for all products or accessories being used.

WARNING

To avoid the device in use from tipping, do not raise or lower other equipment close to it and be aware of stationary object when lowering.

WARNING

To avoid entrapment of the patients or caregivers legs or feet, make sure that they are kept clear of all obstacles.

WARNING

To avoid entrapment, make sure to keep the patients hair, arms and feet close to the body and use designated grab supports during any movement.

WARNING

To avoid the device from tipping and the patient from falling, do NOT use the equipment on floors with recessed drains, holes or slopes exceeding a ratio of 1:50 (1.15°).

WARNING

To avoid explosion or fire, never use the equipment in oxygen rich environment, in presence of heat source or flammable anesthetic gases.

WARNING

To avoid device from tipping and patient from falling, do NOT sit on the head or foot end of the device.

WARNING

To prevent shortage of external air and drip solution to patient, make sure tubes are clear from obstacles and constantly supervised.

WARNING

To avoid risk of injury do not place Sara Combilizer with patient in head down tilt greater than -15° .

Degree of tilt can be assessed on the tilt angle indicator located under the head section of the Sara Combilizer.

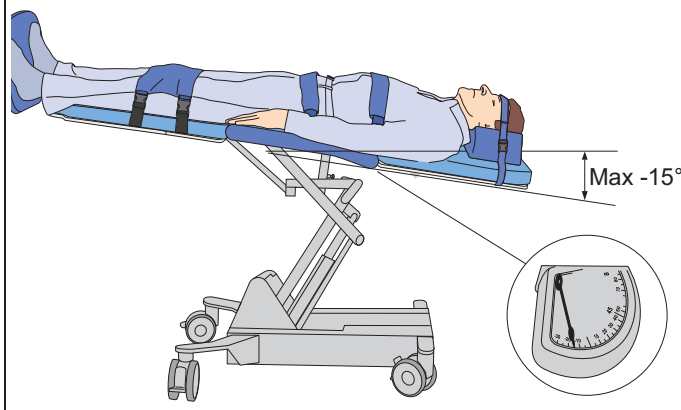

Preparations

Actions Before the First Use (16 steps)

1. Remove packaging and straps around chassis and foot support.
2. The packaging should be recycled according to local regulations. See section *Technical Specifications on page 62*.
3. Unpack all cardboard boxes.
4. Retrieve *IFU* from smaller box and read it.
5. Visually inspect the *Sara Combilizer* for transport damage.
6. Check that all parts of the product are supplied. See section *Parts Designation on page 8*. If any part is missing or damaged - Do not use the product.
7. Attach pillow, see section *Pillow on page 19*.
8. Remove the protection plug inserted into the hand control cable connection point on the transport handle and put it in a safe place. The protection plug will be needed during cleaning and disinfection.
9. Connect the hand control to the hand control cable connection point on the transport handle. See section *Control Functions on page 22*.
10. Unpack the battery charger. For charging and charger installation instructions see the *NEA 8000 Battery Charger IFU*.
11. Charge the battery for 24 hours.
12. Insert the charged battery in the chassis and perform a functionality test, see section *Perform functionality test on page 58*.
13. Store extra textile covers, safety belts, attachment straps, battery and the protection plug in a dry and safe place.
14. Clean and disinfect the product according to *Cleaning/Disinfection Regular on page 51*.
15. Keep the *IFU* safe and accessible at all times.
16. Make sure to have a rescue plan ready in case of a patient emergency.

Actions Before each Use (5 steps)

1. Check that all parts of the *Sara Combilizer* are in place. Compare with the *Parts Designation* section in this *IFU*.

2. **WARNING**

To prevent patient from falling, make sure that the safety belts are undamaged. If damaged, do NOT use the safety belts, replace with new ones before use.

Check the safety belts. See section *Care and Preventive Maintenance on page 55*.

3. If any part is missing or damaged - do NOT use the product!
4. Make sure that the battery is fully charged. See the *NEA 8000 Battery Charger IFU*.

5. **WARNING**

To prevent cross-contamination, always follow the disinfection instructions in this *Instructions for Use*.

Clean and disinfect the product between each patient. See section *Cleaning and Disinfection Instructions on page 47*.

NOTE

If you have any questions, please contact your local Arjo representative for support and service.

CAUTION

Do not use *Sara Combilizer* immediately after storage at below 0°C (32°F) because it can become damaged if used while still cold. Let *Sara Combilizer* stand in room temperature until warmed up before using the equipment.

Parts Designation

Front view

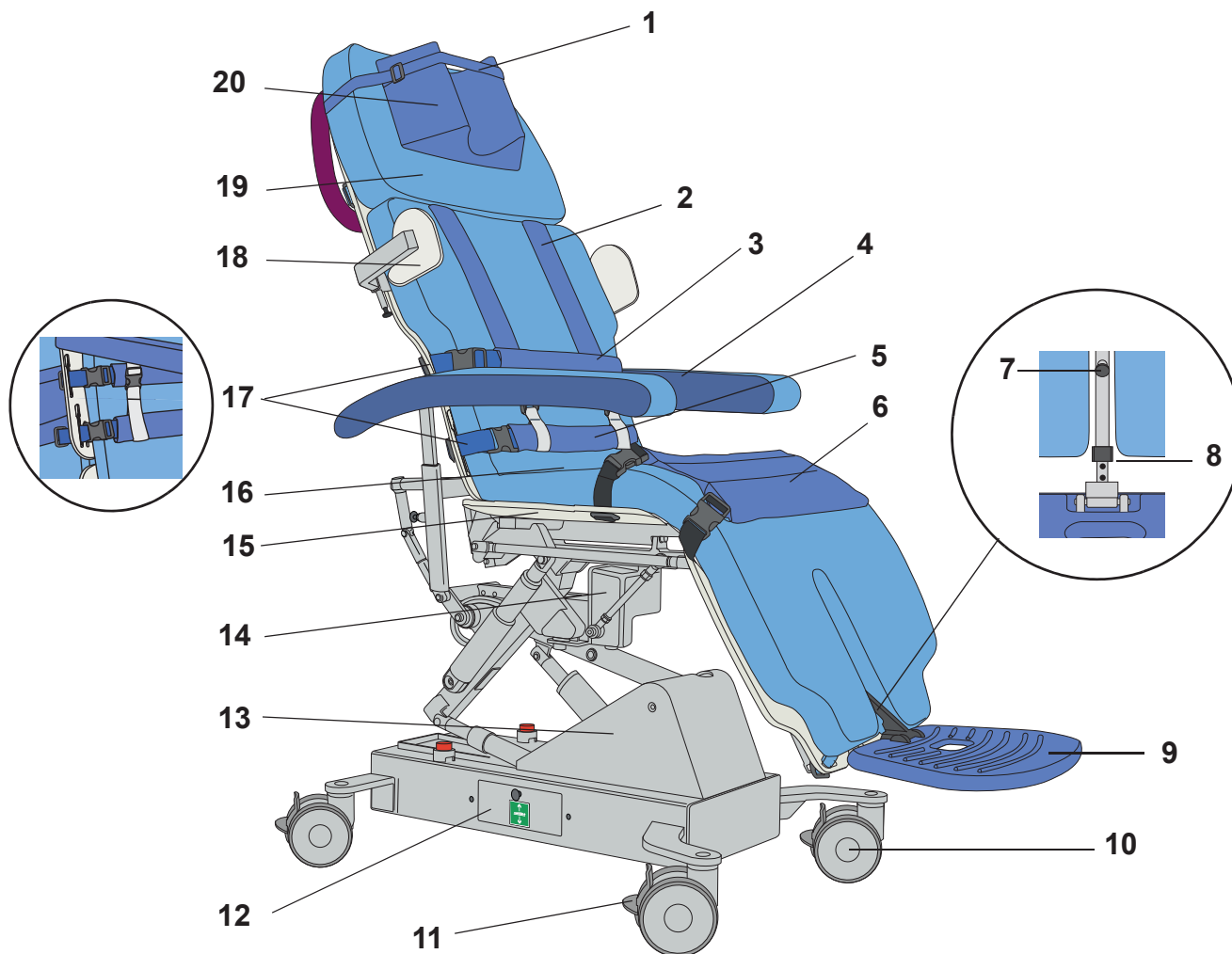

- | | |
|---|----------------------------------|
| 1. Head safety belt * | 14. Change mode mechanism |
| 2. Shoulder safety belts * | 15. Seat plate |
| 3. Chest safety belt * | 16. Body mattress * |
| 4. Armrest * (x2) | 17. Belt attachment strap * (x8) |
| 5. Hip safety belt * | 18. Shoulder support * (x2) |
| 6. Knee safety belt * | 19. Head mattress * |
| 7. Spring lock (for foot support length adjustment) | 20. Pillow * |
| 8. Catch (for foot support length adjustment) | * = detachable part |
| 9. Foot support * | |
| 10. Castor (x4) | |
| 11. Castor brake (one on each castor) | |
| 12. Emergency function box | |
| 13. Chassis and lifting mechanism | |

Extra items delivered:

- one head pillow cover
- one head mattress cover
- one body mattress cover
- two armrest covers
- one chest, one hip and one knee safety belt (including cover, padding, belt attachment straps)

Rear view

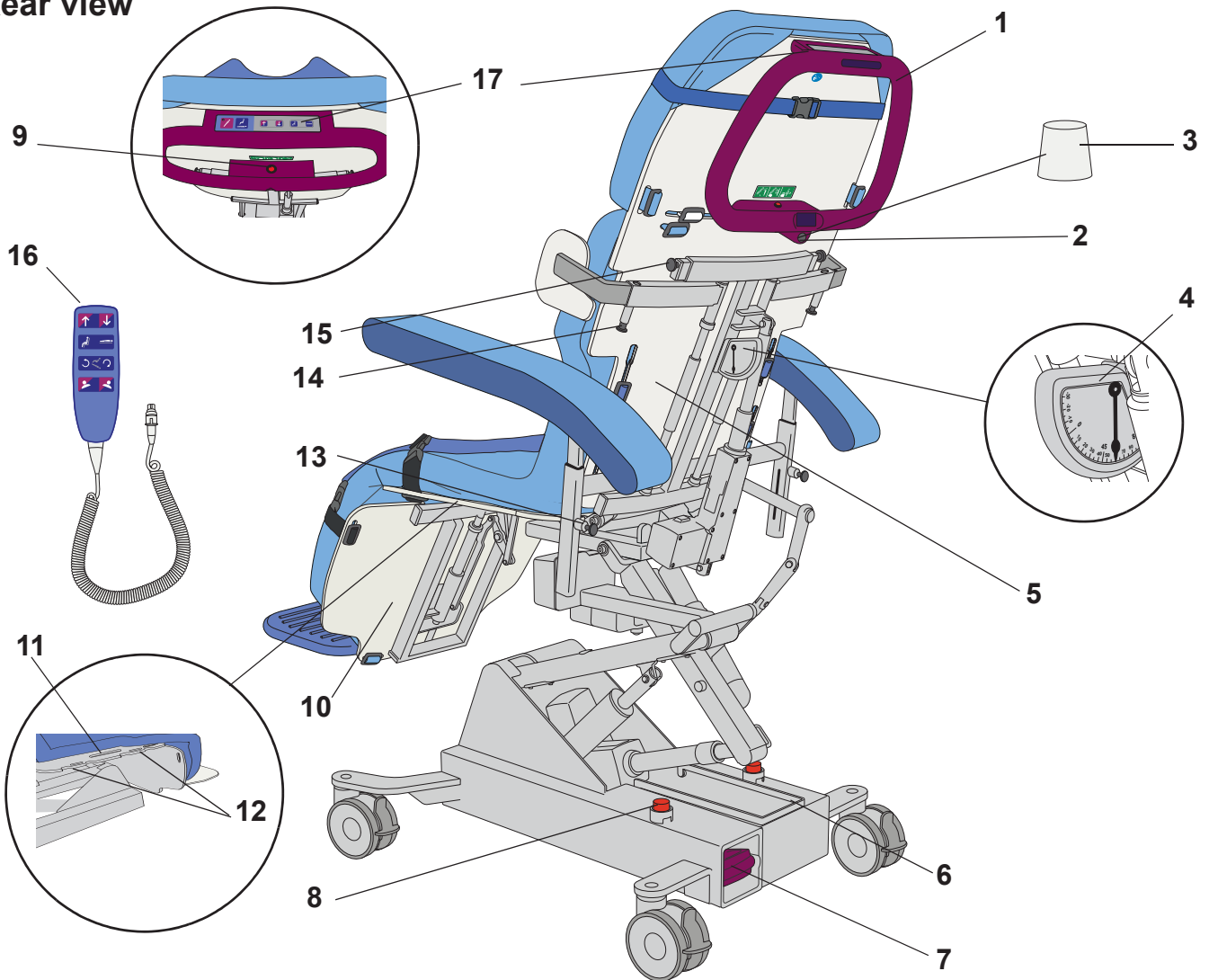

- | | |
|--|---|
| 1. Transport handle | 13. Spring lock (x2) (for armrest height) |
| 2. Hand control cable connection point | 14. Spring lock (x2) (for shoulder support width) |
| 3. Protection plug * (for hand control connection point) | 15. Spring lock (x2) (for shoulder support release) |
| 4. Tilt angle indicator | 16. Hand control with cable * |
| 5. Back support plate | 17. Control panel |
| 6. Pinch protection bar | * = detachable part |
| 7. Battery * | |
| 8. Emergency stop button (x2) | |
| 9. Tilt Table Release button | |
| 10. Leg support plate | |
| 11. Side transport handle (x2) | |
| 12. Attachment slot (x4) (for fluid bags) | |



Entire Product
Applied part: Type B
Protection against
electric shock in
accordance with IEC
60601-1.

Extra items delivered:

- one extra battery with battery charger

Product Description/Functions

This section describes the parts of the *Sara Combilizer*; their function and gives information relevant for using the equipment safely. The parts are indicated in the *Parts Designation* on page 8 and 9.

For information about Control Functions see section *Control Functions* on page 22.

For information about Safety Belts see section *Safety Belts* on page 25.

Sara Combilizer Directions

Left and right

The *Sara Combilizer* has a left and right side. (See Fig. 1)

Fig. 1

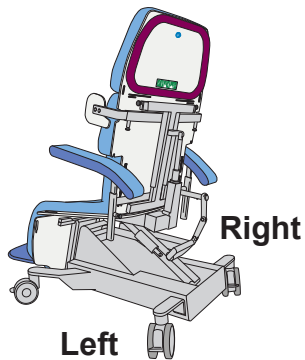
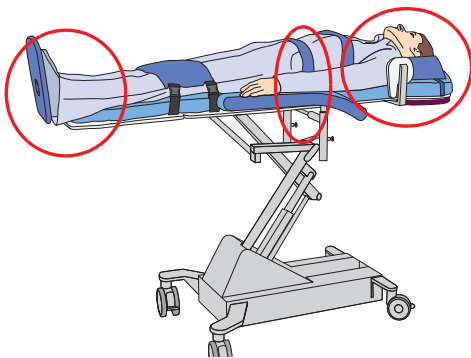

Fig. 2

Foot end Hip Head end



Patient position

When using the *Sara Combilizer* always position the patient with the patient's head towards the head end and the feet towards the foot end. Make sure the patient's hips are centrally positioned over the gap between the back support plate and the seat plate. (See Fig. 2)

Fig. 3

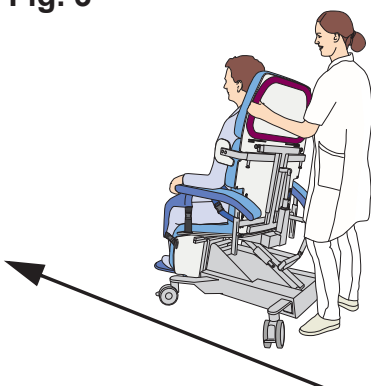

Transport direction

The caregiver must be positioned behind the *Sara Combilizer* during transport. (See Fig. 3)

Sara Combilizer Positions

The *Sara Combilizer* can be set to various positions during use as follows:

Fig. 4

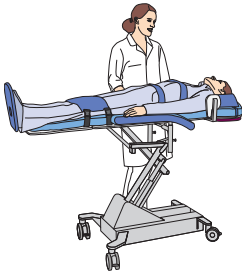

Stretcher position

This position is used during transfer of patient to and from a bed. (See Fig. 4)

The *Sara Combilizer* must be in its horizontal and lowest position, before change to tilt table position is possible.

Fig. 5

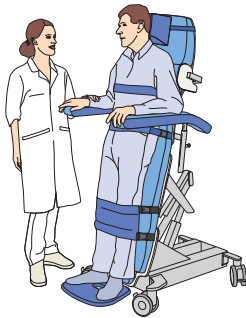

Tilt table position

This position is used to place the patient into the standing position. The angle can be adjusted between 0° and 75° . When the tilt table is at 0° it is in a horizontal position. (See Fig. 5)

The *Sara Combilizer* must be in the horizontal and lowest position, before change to stretcher position is possible.

Fig. 6



Chair position

This position is used to place the patient into a sitting position. The chair can be tilted backwards and forwards to a horizontal chair position. (See Fig. 6)

To save space, store the *Sara Combilizer* in chair position.

Fig. 7

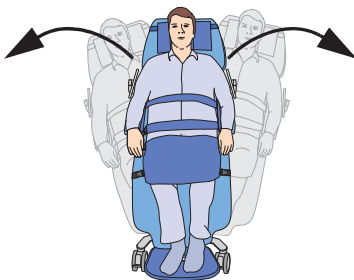

Tilted position (left/right)

A sideways tilt of the *Sara Combilizer* can be performed in the following positions: stretcher, chair and tilt table. (See Fig. 7)

Fig. 8

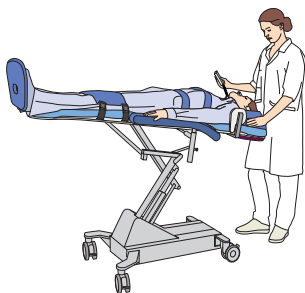

Trendelenburg position

When in horizontal stretcher position the product can be tilted to a Trendelenburg position (more than -12°). It is possible to adjust the angle from 0° to -25° . To avoid risk of injury do not place *Sara Combilizer* with patient in head down tilt greater than -15° . (See Fig. 8)

Fig. 1

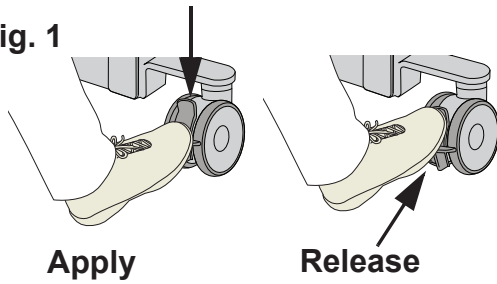

Castor Brakes

Each of the four castors has a brake lever. The castor brakes should be locked on at least two castors. It is recommended to apply all four castors when it is possible. (See Fig. 1)

Apply the brake:

Press down on the grey castor brake lever.

Release the brake:

Slightly kick up the grey castor brake lever.

Fig. 2

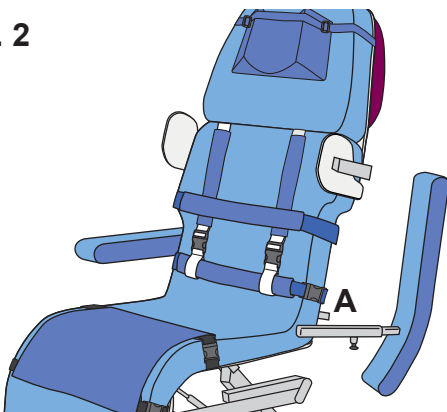

Armrest

The *Sara Combilizer* has two armrests. The armrests are adjustable for width and height and can also be removed.

When changing the *Sara Combilizer* position, the armrests will remain in horizontal position. It is also possible to manually adjust height and width.

Attach armrest (3 steps)

1. Rotate the armrest 90 degrees up/back until it is in a vertical position. (See Fig. 2)
2. Slide the armrest onto the connection rod (A). (See Fig. 2)
3. Fold down the armrest to a horizontal position. (See Fig. 3)

Fig. 3

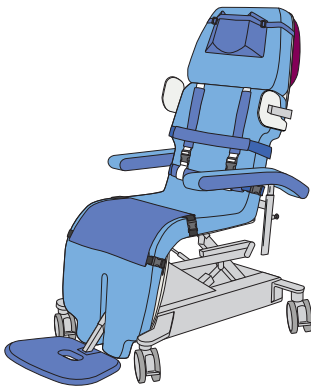
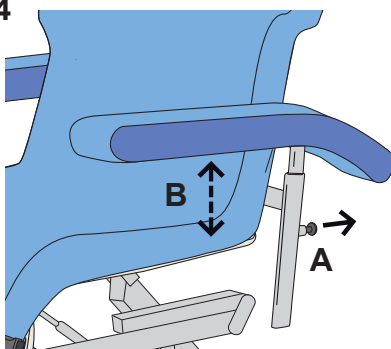

Fig. 4



Adjust armrest height (2 steps)

There are multiple height positions to choose from.

1. Hold onto the armrest with one hand, with the other pull and hold the spring lock knob (A). (See Fig. 4)
2. Raise or lower (B) the armrest and release the spring lock knob. (See Fig. 4)

Fig. 5

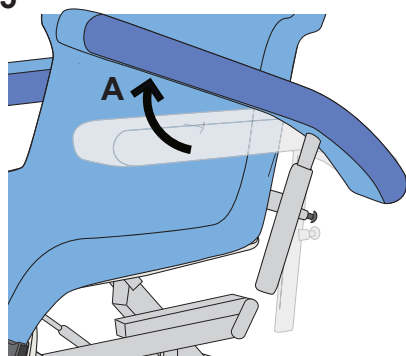

Adjust armrest width (3 steps)

There are multiple width positions to choose from.

1. Tilt the armrest up/back slightly (approx. 20 degrees) (A). (See Fig. 5)
2. Grab the bar (B) and pull or push the armrest to adjust the width. (See Fig. 6)
3. Fold down the armrest to a horizontal position. (See Fig. 7)

Fig. 6

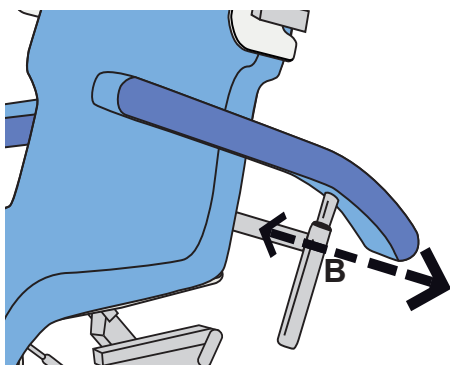

Fig. 7

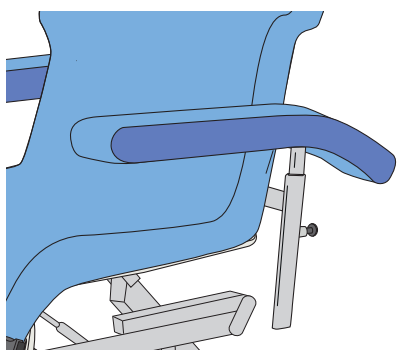
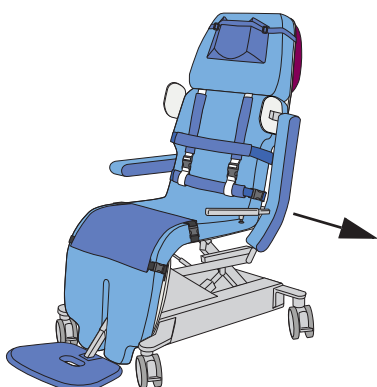

Fig. 8



Remove armrest (3 steps)

1. Make sure that the armrest is in its outermost position. See *Adjust armrest width (3 steps)* on page 13.
2. Grab the armrest and rotate it 90 degrees up/back until it is in a vertical position. (See Fig. 8)
3. Pull out and remove the armrest.

Fig. 1



Foot Support

The *Sara Combilizer* has a foot support. The foot support is adjustable for length. It can also be removed.

The *Sara Combilizer* will automatically adjust the distance between the seat and foot support during a position change. There is also a possibility to adjust the foot support manually. Manual adjustments are always recommended after each position change.

To adjust the foot support in chair position, raise *Sara Combilizer* to an ergonomic height. Adjustment can be facilitated by using the thigh to support the weight. (See Fig. 1)

Fig. 2

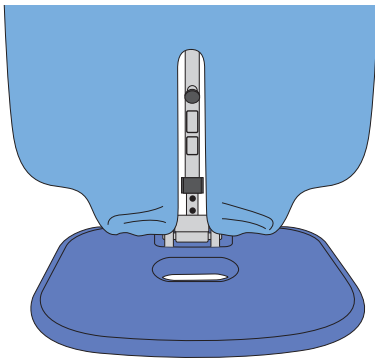

When *Sara Combilizer* is in tilt table position the foot support should be in its highest uppermost position. (See Fig. 2)

Fig. 3

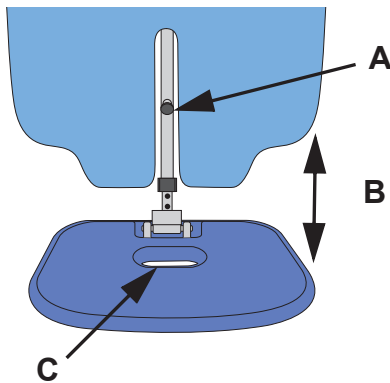

Adjust length of foot support (4 steps)

1. Pull out the upper spring lock (A). (See Fig. 3)
2. Adjust the foot support by raising or lowering the foot support plate (B), by using the foot support handle (C). (See Fig. 3)
3. Release the spring lock.
4. Make sure that the foot support is secured by pushing and pulling it up and down.

Fig. 4

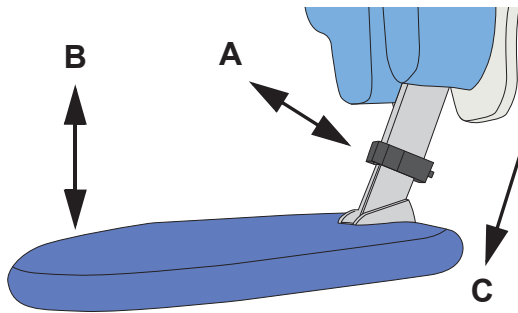

Adjust additional length of foot support (4 steps)

1. Pull the lower catch forward (A). Do not release the catch. (See Fig. 4)
2. Adjust the length of the foot support arm by raising or lowering the foot plate (B). (See Fig. 4)
3. Release the catch (A). (See Fig. 4)
4. Make sure that the foot support is secured by pushing and pulling it up and down.

Remove the foot support (3 steps)

1. Pull the catch forward (A). Do not release the catch. (See Fig. 4)
2. Remove the foot support (C). (See Fig. 4)

WARNING

To avoid injury during handling be aware that the foot support plate is heavy.

3. Release the catch.

Fig. 5

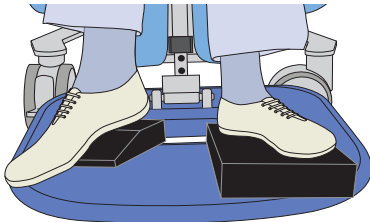

Foot Support Blocks for height adjustment (Accessories)

For a more comfortable position, place blocks under the patient's feet to adjust the height. (See Fig. 5) See section *Parts and Accessories* on page 74.

Shoulder Support

The *Sara Combilizer* has two shoulder supports. The shoulder supports are adjustable for width and can also be folded or removed during transfer.

Fig. 1

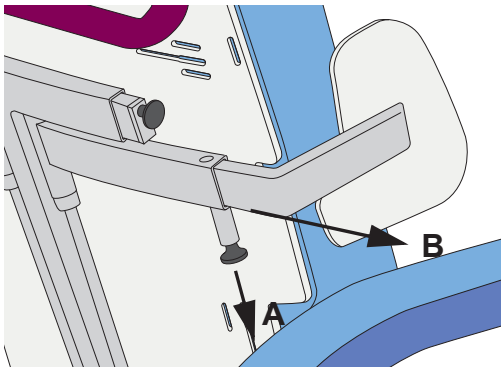

Adjust shoulder support width (4 steps)

1. Pull out the spring lock behind the back support (A). (See Fig. 1)
2. Position the shoulder support at a desired width (B). (See Fig. 1)
3. Release the spring lock.
4. Make sure that the shoulder support is secured by pushing and pulling it in and out.

Fold down shoulder support

NOTE

Be aware that the shoulder support will fold down quickly.

Fig. 2

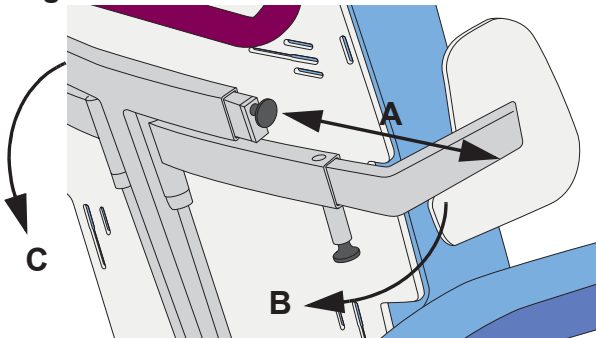

Caregiver side (2 steps)

1. Push in the spring lock (A). (See Fig. 2)
2. The shoulder support (B) will fold down. (See Fig. 2)

Opposite side from caregiver (2 steps)

1. Pull out the spring lock (A). (See Fig. 2)
2. The shoulder support (C) will fold down. (See Fig. 2)

Fig. 3

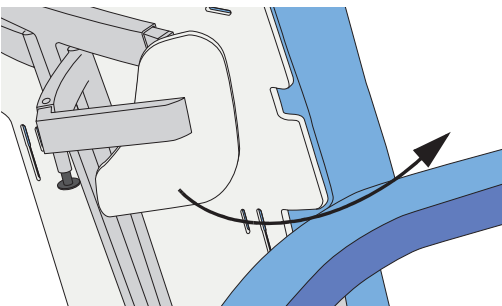

Fold up shoulder support (2 steps)

1. Lift up the shoulder support until it locks into place. (See Fig. 3)
2. Make sure that the shoulder support is secured by pushing and pulling it.

Fig. 1

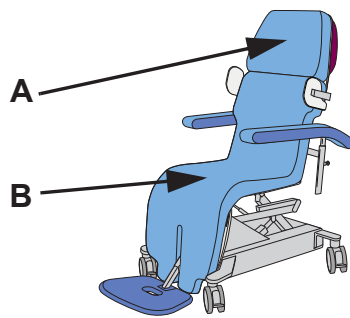

Mattresses

There are two mattresses, one head mattress (A) and one body mattress (B). (See Fig. 1)

It is recommended to have the *Sara Combilizer* in the chair position when attaching or removing the mattresses.

Fig. 2

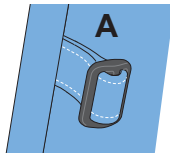

Mattress attachment straps

The head mattress has two (2) and the body mattress has eight (8) attachment straps (A) with a slip lock at the end. (See Fig. 2)

Fig. 3

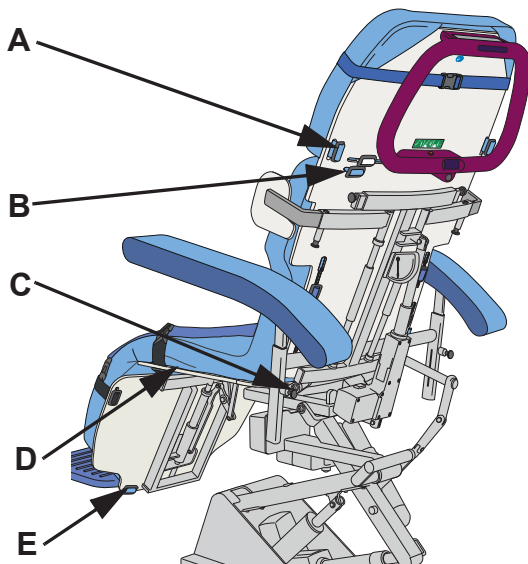

Attachment points

A: Back support plate, head part (x2)

B: Back support plate, shoulder part (x2)

C: Back support plate, lower body part (x2)

D: Seat plate (x2)

E: Leg support plate (x2)

(See Fig. 3)

Fig. 4

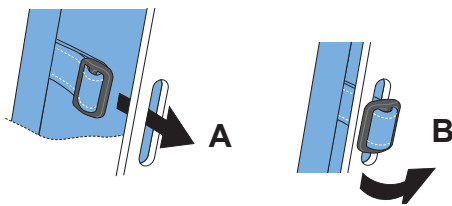

Attach the mattress attachment strap (3 steps)

1. Insert the mattress attachment strap through the slot (A). (See Fig. 4)
2. Always use the inner shorter slot for attachment straps, when applicable.
3. Turn the attachment strap and pull it to secure its attachment (B). (See Fig. 4)

Fig. 5

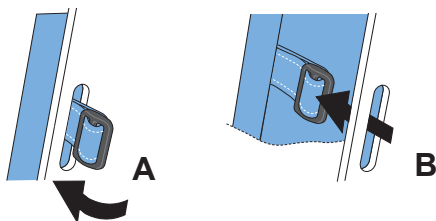

Remove the mattress attachment strap (2 steps)

1. Loosen the attachment strap by pushing it further into the slot (A). (See Fig. 5)
2. Turn the attachment strap and pull it out through the slot (B). (See Fig. 5)

Fig.6

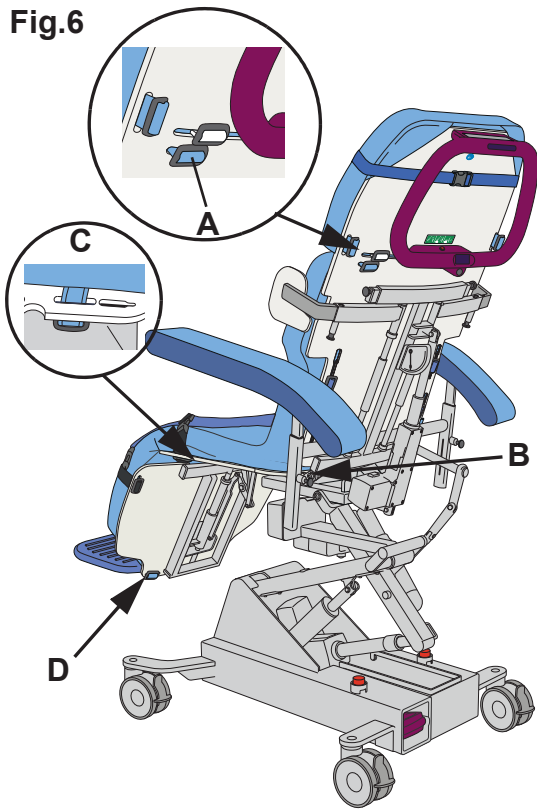

Attach the body mattress (5 steps)

1. Place the body mattress on top of the support surface.
2. Insert the attachment straps with slip locks through the lower slot (A), located on the back support plate. (See Fig. 6)
3. Turn the slip lock and secure it against the back support plate.
4. Repeat the same as above with the remaining attachment straps (B, C, D). (See Fig. 6)
5. Always use the inner slot for attaching mattress, when applicable.

Remove body mattress (2 steps)

1. Remove the body mattress attachment straps from the support plates. (See Fig. 6A-D)
2. Remove the mattress.

Attach head mattress (3 steps)

1. Place the head mattress cover pockets (See Fig. 7A) over the top corners of the back support plate.
2. Insert the head mattress attachment straps through the slots (See Fig. 7B) in the back support plate.
3. Turn the slip lock buckles and secure them against the back support plate.

Remove head mattress (2 steps)

1. Remove the head mattress attachment straps from the support plate. (See Fig. 7B)
2. Lift up the head mattress and remove it from the back support plate.

Fig. 7

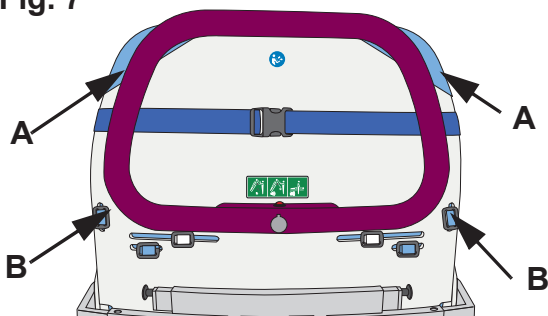
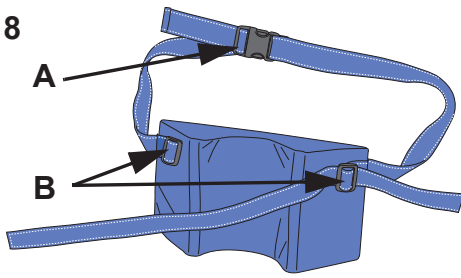

Fig. 8



Pillow

The *Sara Combilizer* head pillow supports the patients head. (See Fig. 8)

The head pillow has two straps with buckles at the end (A). The pillow also has two slip locks for attachment of head belt (B).

Attach pillow (4 steps)

1. Place the pillow on the head mattress. (See Fig. 9)
2. Place the straps around the back support plate and underneath the transport handle. (See Fig. 10)
3. Buckle the straps together to secure the pillow.
4. To tighten, adjust the straps.

Remove pillow (2 steps)

1. Unbuckle the pillow straps (See Fig. 10)
2. Remove the pillow.

Fig. 9

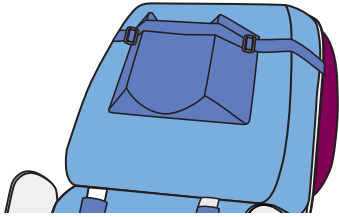

Fig. 10

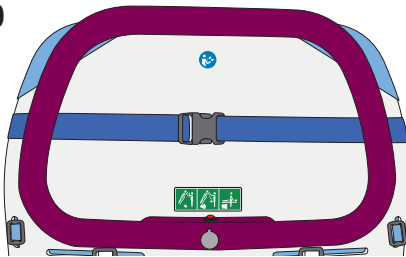

Fig. 1

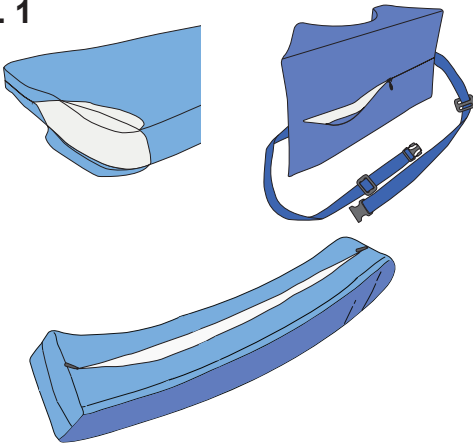
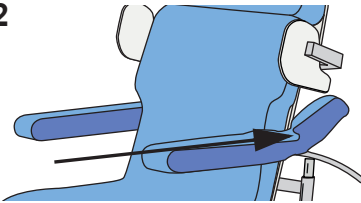

Fig. 2



Covers for Mattresses and Pillow

The covers for the head mattress, body mattress, pillow, armrest cushion and the safety belt covers are all removable for cleaning and disinfection.

Remove the covers (2 steps)

1. Unzip the cover. (See Fig. 1)
 - Body mattress: on the top.
 - Head mattress: on the bottom.
 - Pillow: on the back.
2. Compress the foam and remove the cover.

Insert the foam into the covers (3 steps)

1. Roll the cover down or turn it inside out.
2. Compress the foam and insert it into the cover.
3. Close with the zipper.

Cover and Foam for Armrest Cushions

Remove cover from armrest (3 steps)

1. Unzip the zippers on the bottom of the armrest. (See Fig. 1)
2. Remove the armrest (cover and foam) from the armrest frame.
3. Remove cover by compressing the foam and rolling the cover off.

Attach cover on armrest (4 steps)

1. Unzip the zippers on the armrest cover.
2. Place the armrest foam in the armrest cover.
3. Place the armrest (foam and cover) on the armrest frame. (See Fig. 2)
4. Close the zippers.

Fig. 1

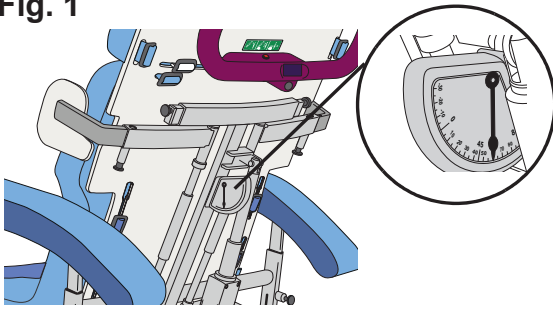

Tilt Angle Indicator

The tilt angle indicator displays the degree of the angle when raising and lowering the tilt table. (See Fig. 1)

The tilt angle indicator is not intended to be used to make clinical decisions. The caregiver must use clinical judgement when using the tilt function.

The working ranges are from -25° to 75° . Accuracy and working precision of the gauge is $\pm 5^{\circ}$.

NOTE

Tilt Angle Indicator does not work when Sara Combilizer is side tilted.

Fig. 2

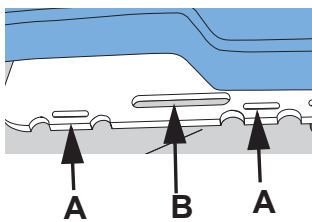

Fluid Bag Attachment Loops

On each side of the seat plate there are slots to attach fluid bags (e.g. catheter bags). (See Fig. 2A)

Side Transport Handles

On each side of the seat plate, there are handles to be used when moving the *Sara Combilizer* sideways. (See Fig. 2B)

Fig. 3

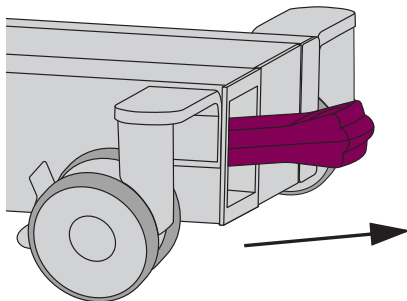

Battery

The *Sara Combilizer* is delivered with two batteries. Always make sure to have the spare battery charged.

Remove the battery: pull it straight out. (See Fig. 3)

Low charge/empty battery: indicated by a pulsating buzzer sound when pressing any button on the hand control/control panel. The sound remains for 10 seconds after the button is released. Replace the battery immediately.

When the battery is indicating empty it is still possible to:

- lower the chair/stretcher/tilt table
- change from chair to stretcher position
- tilt left/right
- tilt upright/tilt back, chair or stretcher

No other movements are possible.

See section *Battery Instructions* on page 54 for more information on the battery.

Control Functions

Fig. 1

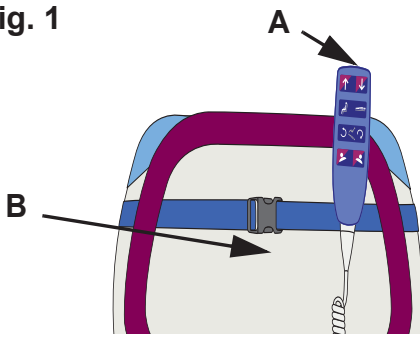

Controls

The *Sara Combilizer* has two control units: Hand control and Control panel

- **Hand Control**

The hand control can be used to change the *Sara Combilizer* into all positions. It cannot be used to change modes.

When not in use, place the hand control on the transport handle (A). The hand control cable is attached to the transport handle (B). (See Fig. 1)

Fig. 2

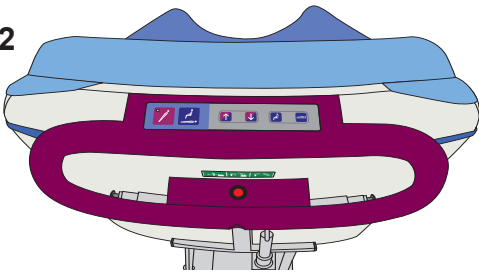

- **Control Panel**

The control panel can be used to change between modes. It also has back-up functions for the basic movements.

(See Fig. 2)

Fig. 3 LED light

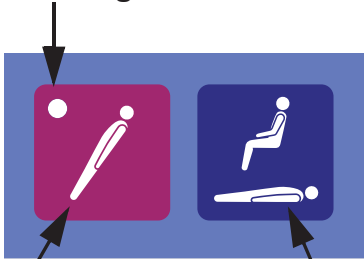

Standing mode

Normal mode

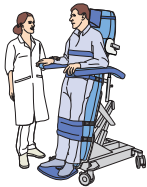

Modes

There are two modes. (See Fig. 3)

The following movements are possible in the different modes:

Standing mode (red)

- up/down
- tilt left/right tilt table

Normal mode (blue)

- up/down
- transform to chair/stretcher
- tilt back/upright as stretcher (Trendelenburg position)
- tilt back/upright as chair
- tilt left/right as chair/stretcher

Fig. 4

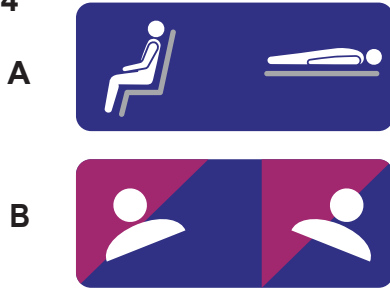

Mode Colour

The function of the button depends on the selected mode. The background colour on the button indicates which mode the buttons can be used in. (See Fig. 4)

- **Blue colour (A)** = normal mode
- **Red and blue colour (B)** = both standing and normal mode

Change of Mode

Only the control panel can be used to change between the modes.

Changing between modes can be done in two ways:

- Use “change of mode” button on control panel
 1. Press the selected change of mode button (the LED light will start to blink to show that *Sara Combilizer* is moving to correct position).
 2. Keep the button pressed until the LED light has changed to constant light (Standing mode) or turned off (Normal mode).
 3. Change of mode will only occur when *Sara Combilizer* is in horizontal stretcher position and at its lowest height.
- Use buttons on hand control followed by selected change of mode button on control panel
 1. Press the selected buttons on the hand control to get *Sara Combilizer* in horizontal stretcher position and at its lowest height.
 2. Press the selected change of mode button (the LED light will start to blink to show that *Sara Combilizer* is preparing for change of mode).
 3. Keep the button pressed until LED light has changed to constant light (Standing mode) or turned off (Normal mode).

Mode Indication on Control Panel

The standing mode button on the control panel has a green LED light.

When pressing the Standing mode button, the LED will start to blink and when the mode change is completed a constant light is shown.

If no button is pressed within 30 minutes the LED light will turn itself off (sleep mode). Pressing any button when in standing mode will activate the light again.

Normal mode has no LED light. When selecting normal mode the LED will start to blink and when the mode change is completed the light will shut off.

Fig. 5 Control Panel

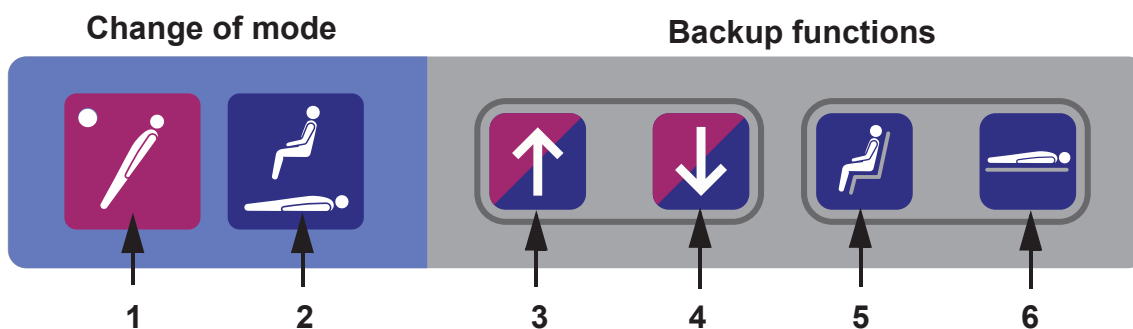
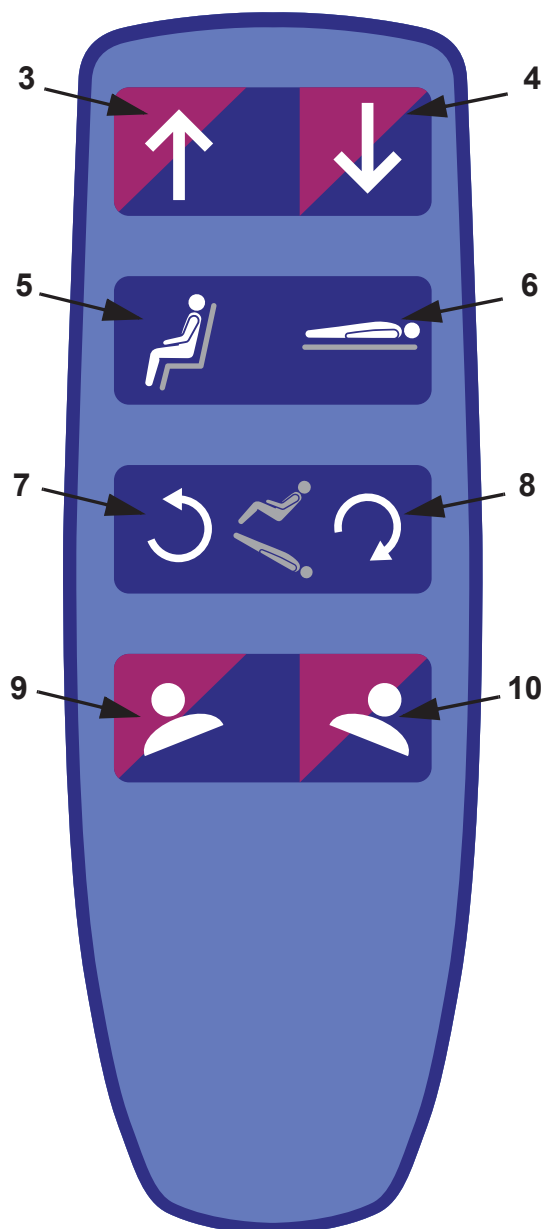

Fig. 6 Hand control



Button Functions

(See Fig. 5 and 6)

1. **Standing mode**
Activates Standing mode.
2. **Normal mode**
Activates Normal mode.
3. **Up**
Normal mode: moves the stretcher or chair upwards.
Standing mode: raises the stretcher into tilt table position.
4. **Down**
Normal mode: moves the stretcher or chair downwards.
Standing mode: lowers the tilt table into stretcher position.
5. **Chair**
Normal mode: changes from stretcher into chair position.
Standing mode: not available.
6. **Stretcher**
Normal mode: changes from chair to stretcher position.
Standing mode: not available.
7. **Tilt upright**
Normal mode: tilts chair or stretcher upwards into horizontal position.
Standing mode: not available.
8. **Tilt back**
Normal mode: tilts the chair backwards or tilts the stretcher back to Trendelenburg position.
Standing mode: not available.
9. **Tilt left**
Normal mode: tilts the stretcher or chair left.
Standing mode: tilts the tilt table left.
10. **Tilt right**
Normal mode: tilts the stretcher or chair right.
Standing mode: tilts the tilt table right.

NOTE

During a tilt left or right, the stretcher or chair will stop for 3 seconds when a horizontal position is reached. If the button is continuously pressed down, the *Sara Combilizer* will stop and then continue to tilt to the other side.

Safety Belts

Fig. 1

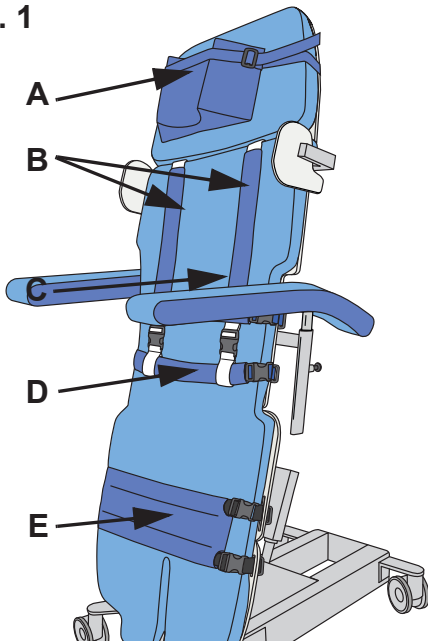

The *Sara Combilizer* has the following safety belts: (See Fig. 1)

- A:** Head safety belt
- B:** Shoulder safety belts
- C:** Chest safety belt
- D:** Hip safety belt
- E:** Knee safety belt

Also delivered with the product is one extra chest safety belt, one extra hip safety belt and one extra knee safety belt.

Always use the chest, hip and knee safety belts in standing position. If needed, use the shoulder and head safety belts as well.

It is recommended to use belts in all positions.

Attachment Straps

All safety belts are colour coded: white, black and blue.

Colour coding for safety belts/attachment straps:

- **Blue:** Hip/chest (A)
- **White:** Shoulder (B)
- **Black:** Knee (C)

(See Fig 2)

All safety belts (except the head safety belt) have slip locks that are used to attach the safety belts to the support plates.

Chest, hip and knee safety belts consist of two belt attachment straps (D) and a belt with padding and cover (E). (See Fig. 2)

The shoulder safety belts consist of one belt with padding and covers (E) and one belt with an attachment strap (D). (See Fig. 2)

The shoulder safety belt attachment straps (D) have loops that are used to attach the shoulder safety belts to the hip safety belt.

(See Fig. 2)

To attach Safety Belts to Support Plates (2 Steps)

1. Insert the slip lock through the upper end of the outer slot (A).
2. Turn the slip lock and pull the attachment strap towards the support surface to secure it (B). (See Fig. 3)

Fig. 2

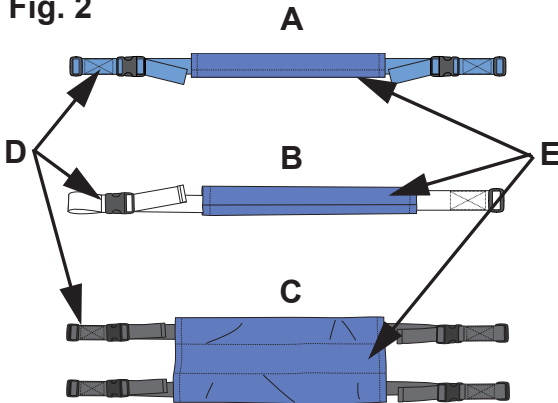
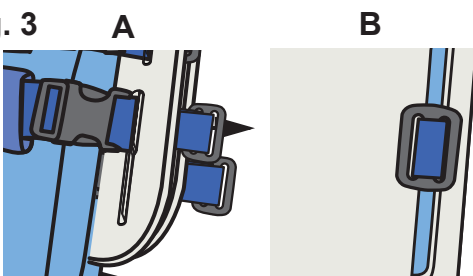

Fig. 3



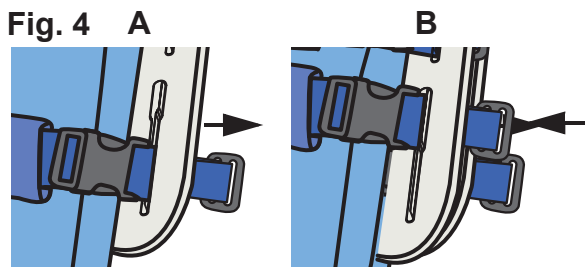

Fig. 5

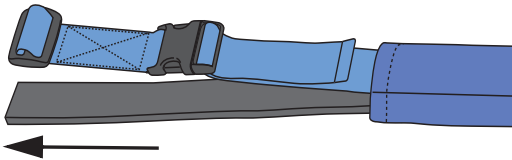

Fig. 6

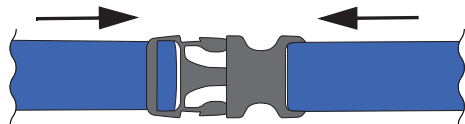

Fig. 7

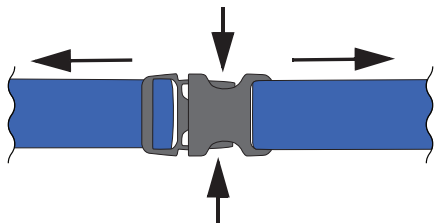

Fig. 8

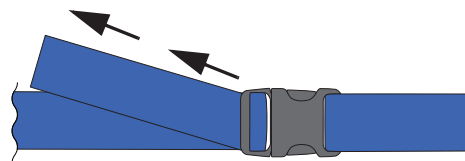
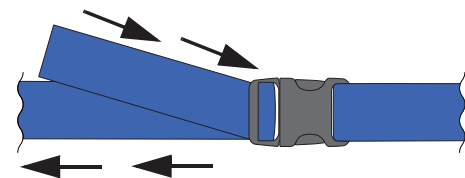

Fig. 9



To remove the Safety Belts (2 steps)

1. Loosen the slip lock by pushing it further into the slot **(A)**. **(See Fig. 4)**
2. Turn the slip lock and pull it out through the upper end of the slot **(B)**. **(See Fig. 4)**

To remove Cover and Padding from Safety Belts (1 Step)

1. Extract padding and belt from cover. **(See Fig.5)**

To add Cover and Padding to Safety Belts (3 Steps)

1. Insert belt webbing into cover.
2. Insert padding under the belt webbing (padding closest to the patient's body).
3. Attach safety belt attachment straps to belt.

Buckle Safety Belt (2 steps)

1. Connect the two buckles together. **(See Fig. 6)**
2. Make sure that the buckle is locked into position.

Unbuckle Safety Belt (1 step)

1. Press the sides of the buckle and pull the straps apart. **(See Fig. 7)**

Tighten Safety Belt (2 steps)

1. Pull the end strap away from the buckle. **(See Fig. 8)**
2. Insert the remaining end strap inside the belt cover.

Loosen Safety Belt (1 step)

1. Lift up the buckle and feed the remaining end strap back through the buckle. **(See Fig. 9)**

Fig. 10



Use of Safety Belts

Always use the chest, hip and knee safety belts when the *Sara Combilizer* is in the tilt table position. If needed, use the shoulder and head safety belt as well. It is recommended to use safety belts in all positions. (See Fig. 10)

NOTE

Always check the safety belts after a position change and make sure that the patient is comfortable and safety belts are properly attached.

Chest safety belt (4 steps)

1. Make sure the chest safety belt is buckled into one of the upper belt attachment straps. (See Fig. 11A)

2. **WARNING**

To avoid risk of strangulation, place the chest safety belt under the arms.

Always position the chest safety belt under the patient's arms to prevent it from sliding up over the throat.

On female patients: position the chest safety belt above or under the female's bust.

3. Buckle the chest safety belt into the other upper attachment strap. (See Fig. 11A)
4. Adjust the chest safety belt to fit the patient. To avoid pressure on the chest, do not tighten the safety belt too much.

Fig. 11

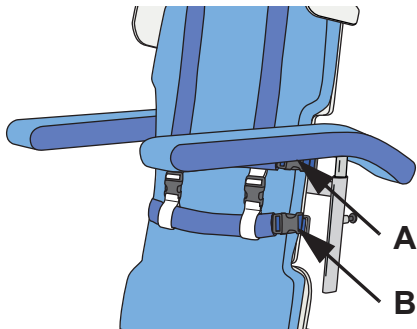

Hip safety belt (4 steps)

1. Make sure the safety belt is buckled into one of the middle belt attachment straps. (See Fig. 11B)
2. Position the hip safety belt on the patient's hip area over the pelvic bone.
3. Buckle the hip safety belt into the other middle attachment strap. (See Fig. 11B)
4. Adjust the hip safety belt to fit the patient. To avoid pressure on the stomach or genitals, do not tighten the safety belt too much.

Fig. 12

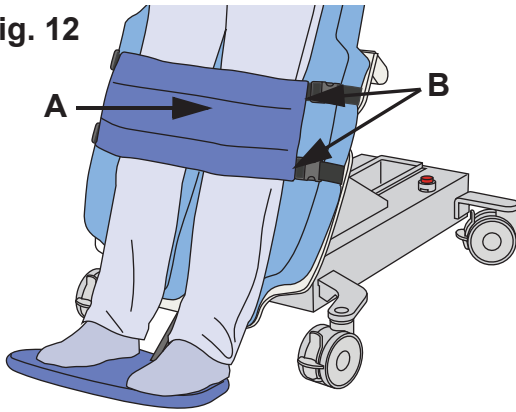

Knee safety belts (4 steps)

1. Make sure the knee safety belts (A) are buckled into two of the lower belt attachment straps (B). (See Fig. 12)
2. Position the knee safety belts over the patient's knee caps.
3. Buckle the knee safety belts into the other two lower belt attachment straps. (See Fig. 12)
4. Adjust the knee safety belts to fit the patient.

NOTE

Pay special attention to the knee safety belts when changing from stretcher to chair position since the strap may be pulled to tight when changing the position.

Shoulder safety belts (5 steps)

1. Attach the two slip locks for shoulder safety belts (A) through the upper slots in the back support plate (B), between the head and body mattresses. Make sure they are secured against the back support plate. (See Fig. 13)
2. Position the shoulder safety belts over the patient's shoulders and below the chest belt (A). (See Fig. 14)
3. Unbuckle the hip safety belt (B) (See Fig. 14) and insert it through the end loops (C) of the shoulder safety belts. (See Fig. 13 and Fig. 14)
4. Buckle the hip safety belt again.
5. Adjust the hip and shoulder safety belts to fit the patient.

Fig. 13

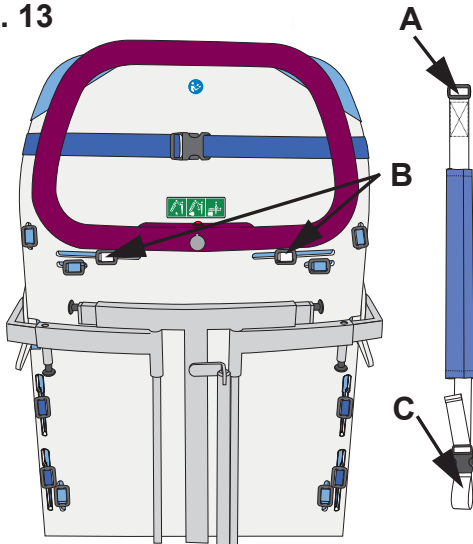

Fig. 14



Head safety belt (2 steps)

1. Pull the head safety belt through the slip lock (A) on both sides of the pillow. (See Fig. 15)

2. **WARNING**

To avoid strangulation due to patient's movement, always supervise the patient when using the head safety belt.

Fig. 15

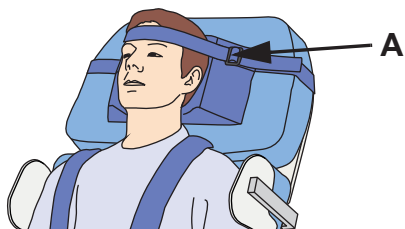

Adjust the head safety belt so that the patient's head is secured.

Emergency and Safety Functions

Fig. 1

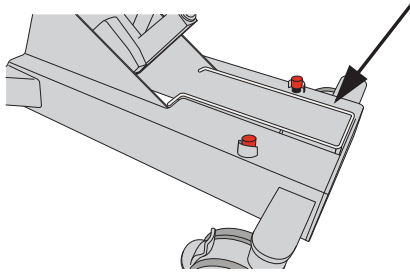

Pinch Protection Bar

The *Sara Combilizer* is equipped with a pinch protection bar. (See Fig. 1) When the pinch protection bar is pressed down, it automatically stops any downward movement.

Emergency Stop

To Activate:

Push down the emergency stop button to cut all power to all the electrical components. (See Fig. 2A) The emergency function box will maintain its function. See section *Emergency Function Box* on page 29

To Deactivate:

Turn the emergency stop button clockwise until it pops back out.

Fig. 2

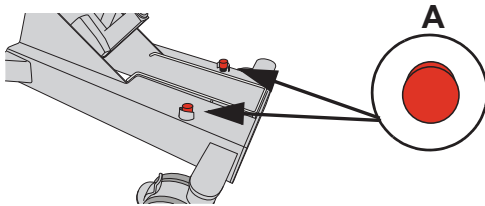

Emergency Function Box

WARNING

To avoid injury, only use the emergency lowering when normal lowering is impossible. Use extreme care during lowering.

If the hand control and control panel do not function, use the Emergency Function Box to change the *Sara Combilizer* position.

NOTE

The number of caregivers to be present during treatment depend on local routines and patient assessment.

Fig. 3

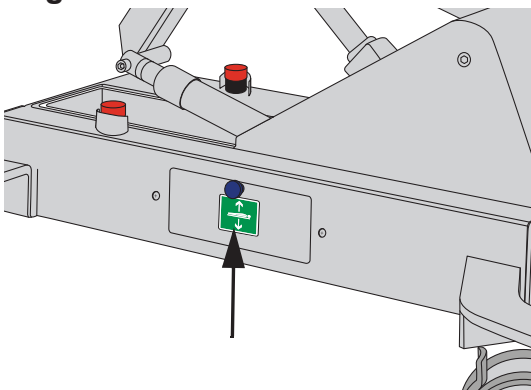

How to use the Emergency Function Box (5 steps)

1. WARNING

To avoid injury, be aware that Emergency Stop and pinch protection bar do not function when EMERGENCY FUNCTIONS are used.

1. The Emergency Function Box is located on the lower frame on the right hand side. (See Fig. 3)
2. Fold down the Emergency Function Box cover. (See Fig. 4)

Fig 4

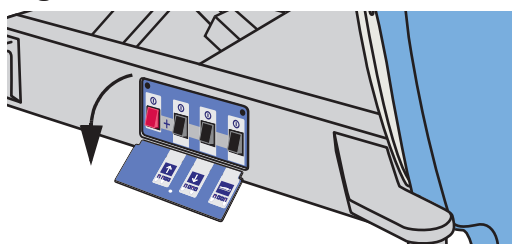

Continue with the steps on the next page.

Fig. 5

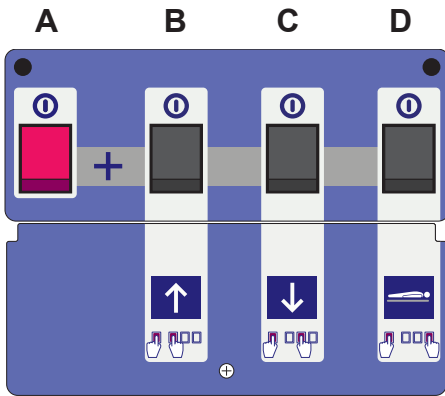

3. **WARNING**
To avoid pinching, keep hands and feet away from moving parts when **EMERGENCY FUNCTIONS** are used.

Press the **Main power switch (A)** and at the same time one of the buttons below: (See Fig. 5)

- **Up:** Raise the stretcher/chair **(B)**
 - **Down:** Lower the stretcher /chair **(C)**
 - **Stretcher:** Change from chair to stretcher position **(D)**.
4. Remove the patient from the *Sara Combilizer*.
5. Call for qualified personnel.

NOTE
When the emergency function box has been used, contact qualified personnel for an inspection and prevent further use.

Tilt Table Release Function

WARNING
To avoid injury, only use tilt table release function when required by patient condition. Use extreme care during lowering.

NOTE
The number of caregivers to be present during treatment depend on local routines and patient assessment.

The Tilt Table Release function is used for quick lowering of the patient from standing to horizontal position when the patient is in a critical condition.

When the Tilt Table Release function is activated the tilt table is unlocked (indicated by a beeping sound) and can be lowered manually.

The force needed to manually lower the tilt table can be high and may require two or more caregivers.

The button **(A)** to activate Tilt Table Release is positioned on the driving handle. (See Fig. 6)

The button is accompanied by a label **(B)** describing the lowering procedure. (See Fig. 6)

Fig. 6

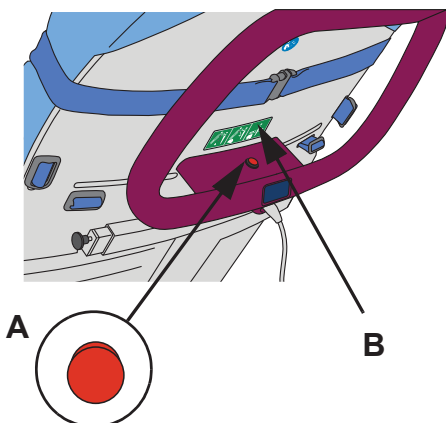

Fig. 1



Fig. 2

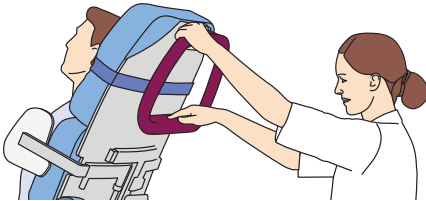

Fig. 3

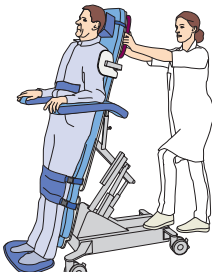

Fig. 4

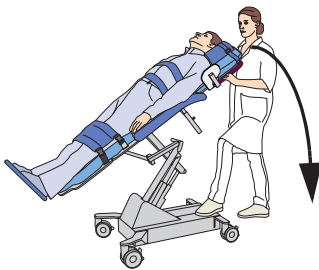

Fig. 5



Fig. 6



Fig. 7

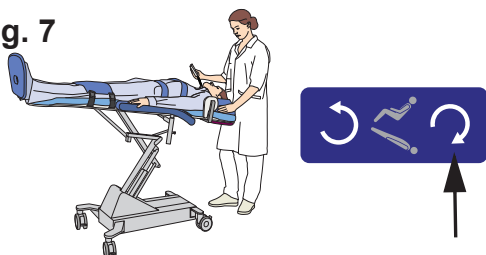

How to use the Tilt Table Release Function (9 steps)

1. Check that the brakes are applied on the *Sara Combilizer*.
2. Make sure that the patient's head is resting on the head pillow or mattress during the whole process. (See Fig. 1)
3. Prior to patient lowering make sure that all IV and monitoring lines, drains, fluid bags and catheters attached to the patient have enough slack, to minimise the risk of accidental disconnection during lowering
4. Position one hand on the transport handle without pulling.
5. Make sure that the pinch protection bar and the emergency stops are not activated.
6. Push the transportation handle. For better support keep one foot on the chassis beam during pushing.
7. Press the button on the transportation handle until the characteristic "click" sound. A beeping sound will be heard (See Fig. 2).

NOTE

The tilt table will continue to move as long as the button is pressed.

8. Release the button and position both hands firmly on the transport handle. (See Fig. 3)

9. WARNING

To avoid injury of the patient's neck and back during emergency lowering, be aware that both the caregiver's hands must be kept on the handle to support the tilt table and the patient's weight.

If the weight is not supported there is a risk that the tilt table will be lowered too fast with an abrupt stop.

Pull the tilt table firmly down until a horizontal position has been reached. For better support keep one foot on the chassis beam during lowering. (See Fig. 4)

10. To complete the procedure press the stretcher down until the beeping sound stops. *Sara Combilizer* is now locked in a horizontal position in Normal mode. (See Fig. 5)

Further actions after lowering

- If needed, adjust the stretcher height. The height of the stretcher will depend on the angle of the tilt table before using the Tilt Table Release function. (See Fig. 6)
- If the patient's condition requires him/her to be placed in a Trendelenburg position, use the Tilt back button. Make a clinical assessment on how long the patient needs to stay in a horizontal/Trendelenburg position. (See Fig. 7)

Operation

The following section gives the details of how to operate the *Sara Combilizer* for different transfer needs of a patient. The operations include:

1. Transfer of patient from bed to *Sara Combilizer* (See below)
2. Transfer of patient from *Sara Combilizer* to bed (See page 36)
3. Transfer of patient from sitting to standing position (See page 39)
4. Transfer of patient from standing to sitting position (See page 41)
5. Change position (See page 43)
6. Transport (See page 46)

Transfer of Patient from Bed to Sara Combilizer

Transferring a patient to or from bed can either be done by lateral transfer methods or with a ceiling or floor lift. See section *Technical Specifications on page 62* for allowed product combinations.

For floor lift, ceiling lift or sliding aid instructions, see respective *IFU*.

Prior to patient transfer make sure that all IV and monitoring lines, drains, fluid bags and catheters attached to the patient have enough slack, to minimise the risk of accidental disconnection during transfer.

Inform the patient about the transfer. (This applies to unconscious patients as well).

Follow these 24 Steps

Fig. 1

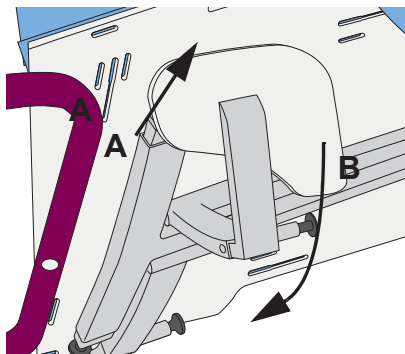

1. Pull out the spring lock (**A**) and fold down the shoulder support (**B**) on the *Sara Combilizer* as needed. (See Fig. 1)

Fig. 2

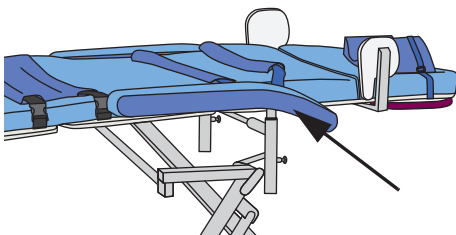

2. Make sure that the armrests (**A**) on the *Sara Combilizer* are removed or in horizontal position, levelled with the mattress and at the innermost position. (See Fig. 2)
3. Remove the *Sara Combilizer* pillow and fold away the safety belts.
4. Apply the brakes on the bed.
5. Adjust the bed to an ergonomic height and into a horizontal position.

Continue with the steps on the next page.

Fig. 3

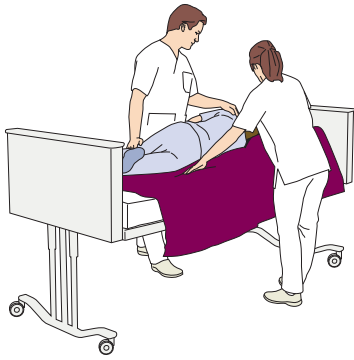

Fig. 4

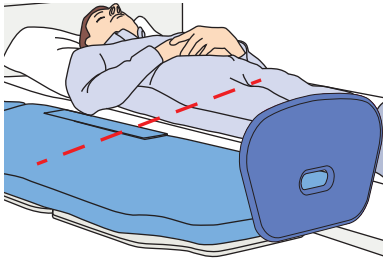

Fig. 5

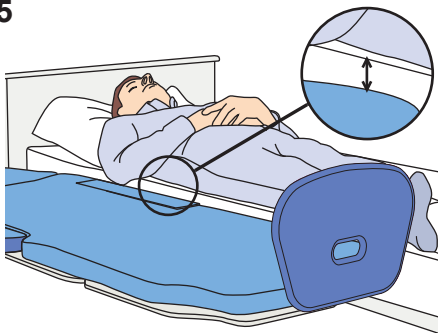
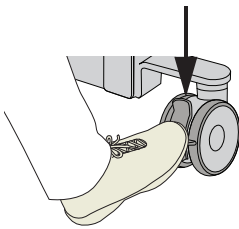

Fig. 6



6. Position one caregiver on each side of the bed. (See Fig. 3)
7. If bed rails are available fold them down on the transfer side.
8. Place sliding aids under the patient (Use local technique). (See Fig. 3)
9. Place a pillow under the patient's head.
10. Position the *Sara Combilizer* next to the bed.
11. Align the patient's hip with the gap between the back support plate and the seat plate on the *Sara Combilizer*. (See Fig. 4)

12. **WARNING**

To avoid the device in use from tipping, do not raise or lower other equipment close to it and be aware of stationary objects when lowering.

Adjust the height of *Sara Combilizer* so that it is 2 to 5 cm (1 to 2 inches) lower than the bed. Make sure that the *Sara Combilizer* does not hit the bed rails during lowering. (See Fig. 5)

13. Adjust the foot support to avoid the patient from hitting her/his feet during the transfer. If needed, remove the foot support completely.

14. **WARNING**

To avoid falling during patient transfer, always make sure that the brakes on the equipment are applied.

Apply the brakes on the *Sara Combilizer*. (See Fig. 6)

Continue with the steps on the next page.

Fig. 7



Fig. 8

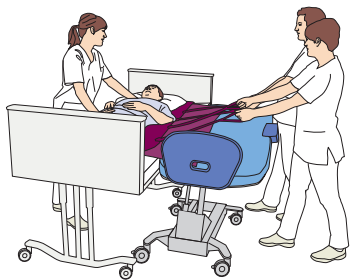

Fig. 9

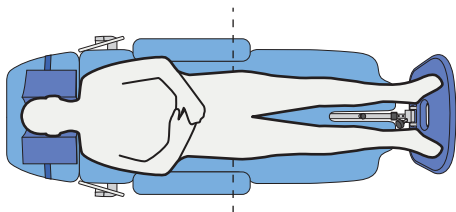
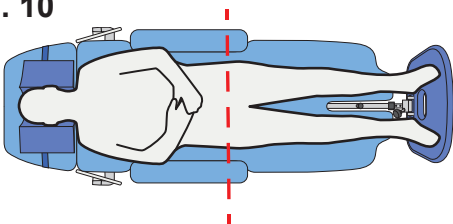

Fig. 10



15. **WARNING**

To avoid injury during the transfer, pay attention to the patient's head and feet and make sure there are no obstacles nearby.

WARNING

To prevent the patient from falling or caregiver from being injured, make sure that there are two or more caregivers present during the patient transfer process.

Transfer the patient with a sliding aid to the *Sara Combilizer*.

See respective sliding aid *IFU*. Examples of transfer with sliding aid:

- Tube (See Fig. 7)
- Sliding sheet (See Fig. 8)

NOTE

The number of caregivers and their positions during the transfer depends on the transfer method being used and the clinical assessment of the patient.

16. **WARNING**

To avoid falling, make sure that the patient is positioned in accordance with this *IFU*.

Position the patient with the head on the head support and the legs on the leg support. (See Fig. 9)

17. Use a sliding aid to adjust the patient's hips so that they are aligned with the gap between the back support plate and the seat plate. (See Fig. 10)

Continue with the steps on the next page.

18. **WARNING**

To prevent the patient from falling, always remove any sliding aid from under the patient once the transfer is complete.

Move the *Sara Combilizer* from the bed and position one caregiver on each side of *Sara Combilizer*.

19. Remove the sliding aid (Use local technique). To avoid pressure and discomfort, make sure that there are no wrinkles or unevenness on the mattress and on the patient's clothing.

Fig. 11

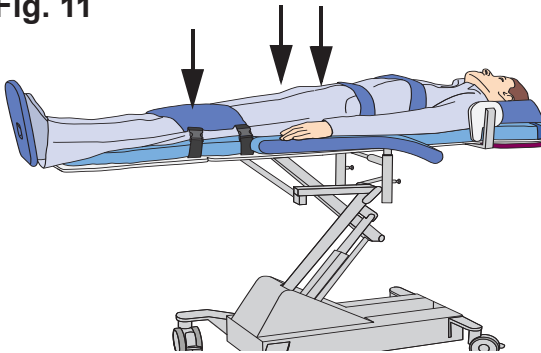

20. **WARNING**

To avoid falling, make sure that the patient is positioned correctly and that the safety belts are being used, properly fastened and tightened.

Secure the patient with the chest, hip and knee safety belts. (See Fig. 11)

21. Place the *Sara Combilizer* pillow under the patient's head and buckle the straps under the transport handle. (See Fig. 11)
22. Fold up the shoulder supports (See Fig. 12) and adjust the width to fit the patient.

Fig. 12

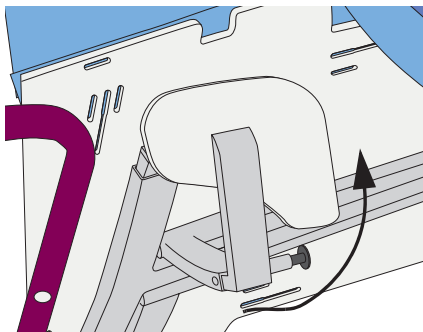

23. **WARNING**

To avoid injury during handling be aware that the foot plate is heavy.

Adjust/attach the foot support to fit the patient's length.

24. The *Sara Combilizer* is now ready for a position change and/or transport. See sections, *Change Position on page 43* and *Transport on page 46*.

Transfer of Patient from Sara Combilizer to Bed

For floor lift, ceiling lift or sliding aid instructions, see respective *IFU*.

Prior to patient transfer make sure that all IV and monitoring lines, drains, fluid bags and catheters attached to the patient have enough slack, to minimise the risk of accidental disconnection during transfer.

Inform the patient about the transfer. (This applies to unconscious patients as well).

Follow these 19 Steps

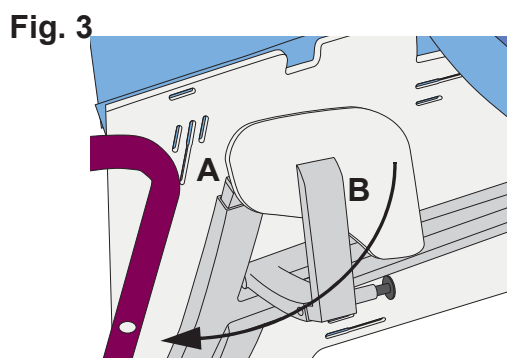
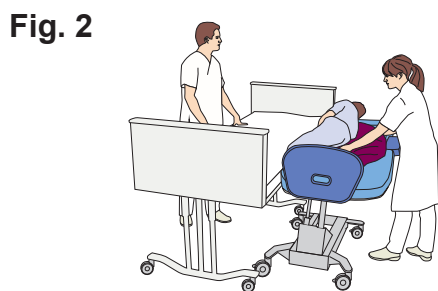
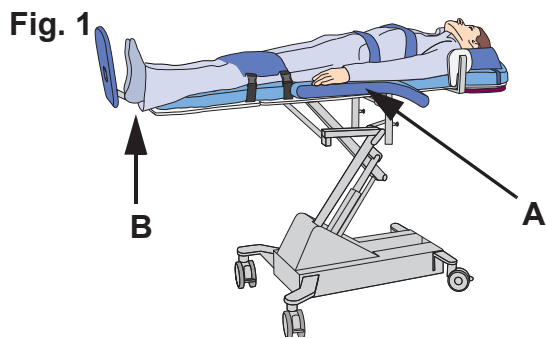

1. **WARNING**
To avoid falling during patient transfer, always make sure that the brakes on the equipment receiving the patient are applied.

Apply the brakes on the bed.

2. Adjust the bed to an ergonomic height and into complete horizontal position.

3. **WARNING**
To avoid patient falling out of the device, make sure that all side supports are in a locked position.

If applicable fold down the bed rail on the transfer side.

4. Make sure that the armrests (A) on the *Sara Combilizer* are removed or in horizontal position, levelled with the mattress and at the innermost position. (See Fig. 1)
5. Adjust the foot support (B) away from the patient's feet or detach the foot support completely. (See Fig. 1)
6. Detach all safety belts on the side facing the bed and fold away.
7. Place sliding aids under the patient (use local technique). (See Fig. 2)
8. Pull out the spring lock (A) and fold down the shoulder support (B) on the bedside on the *Sara Combilizer*. (See Fig. 3)

Continue with the steps on the next page.

Fig. 4

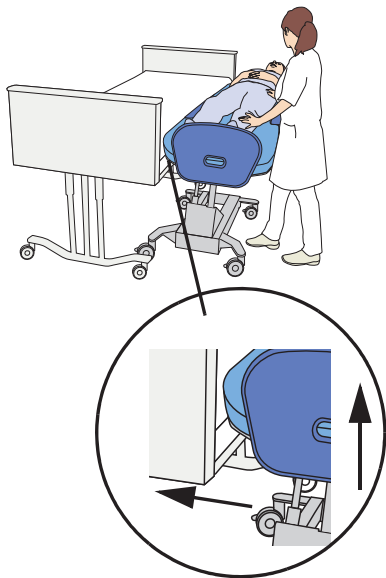

9. Position the *Sara Combilizer* close to the bed and adjust the height so that it's 5 cm (2 inches) above the bed. (See Fig. 4)
10. Position the *Sara Combilizer* so that it is overlapping the bed. (See Fig. 4)

11. **WARNING**

To avoid the device in use from tipping, do not raise or lower other equipment close to it and be aware of stationary object when lowering.

Lower *Sara Combilizer* and make sure it is on top of the bed for an even transfer.

12. **WARNING**

To avoid falling during transfer, always make sure that the brakes are applied on all equipment being used.

Apply the brakes on the *Sara Combilizer*. (See Fig. 5)

13. **WARNING**

To avoid the patient from falling or caregiver from being injured, make sure that there are two or more caregivers present during the patient transfer process.

Position one caregiver on the side of the *Sara Combilizer* and one caregiver on the opposite side of the receiving bed.

14. If needed remove the *Sara Combilizer* pillow.

Fig. 5

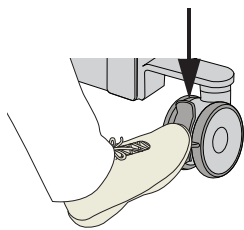

Continue with the steps on the next page.

Fig. 6

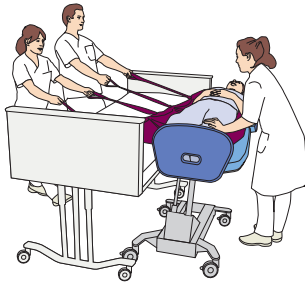

Fig. 7

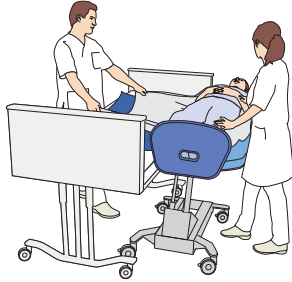

Fig. 8

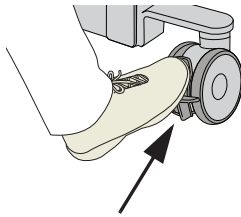
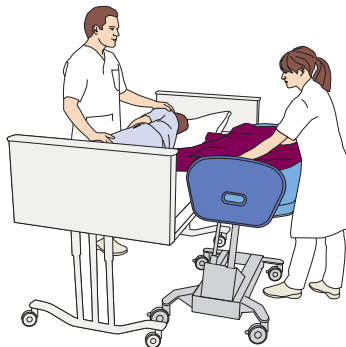

Fig. 9



15. **WARNING**

To avoid injury during the transfer, pay attention to the patient's head and feet and make sure there are no obstacles nearby.

WARNING

To avoid falling during patient transfer, always make sure that the brakes on the equipment receiving the patient are applied.

Transfer the patient with the sliding aid to the bed. See respective sliding aid *IFU*.

Examples of transfer with a sliding aid:

- Sliding sheet (See Fig. 6)
- Tube (See Fig. 7)

NOTE

The number of caregivers and their positions during the transfer depends on the transfer method and aid being used and the patient assessment.

16. Release the brakes and move the *Sara Combilizer* away from the bed. (See Fig. 8)

17. **WARNING**

To prevent the patient from falling, always remove any sliding aid from under the patient once the transfer is complete.

Remove the sliding aid from under the patient (Use local technique).

18. Make sure that there are no wrinkles or unevenness on the mattress or on the patient's clothing that can cause pressure or discomfort. (See Fig. 9)

19. **WARNING**

To avoid patient falling out of the device, make sure that all side supports are in a locked position.

If applicable fold up the bed rails on the bed.

Transfer of Patient from Sitting to Standing Position

Only transfer a patient from sitting to standing position when the clinical assessment of the patient allows it.

For the allowed combination of walking/standing and raising aid, see section *Technical Specifications on page 62*. For active aid instructions, see respective aid *IFU*.

Prior to patient transfer make sure that all IV and monitoring lines, drains, fluid bags and catheters attached to the patient have enough slack, to minimise the risk of accidental disconnection during transfer.

Inform the patient about the transfer.

NOTE

The number of caregivers and their positions during the transfer depends on the transfer method being used and the clinical assessment of the patient.

Follow these 13 Steps

Fig. 1

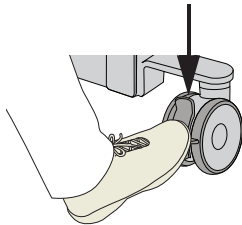

1. Prepare the aid and place it near the *Sara Combilizer*.

2. **WARNING**

To avoid falling during transfer, always make sure that the brakes are applied on all equipment being used.

Apply the brakes on *Sara Combilizer*. (See Fig. 1)

Fig. 2



3. Make sure that *Sara Combilizer* is in an upright and lowest chair position. For position instructions, see section *Change Position on page 43*.
4. Fold down the shoulder support on the transfer side. See section *Shoulder Support on page 16*
5. Remove the armrests on the transfer side. See section *Armrest on page 12*
6. Detach all safety belts.
7. Carefully rotate the patient to the transfer side. (See Fig. 2)
8. Carefully tilt *Sara Combilizer* towards the transfer side so that the patient's feet can reach the floor. (See Fig. 3)

Fig. 3



Continue with the steps on the next page.

Fig. 4

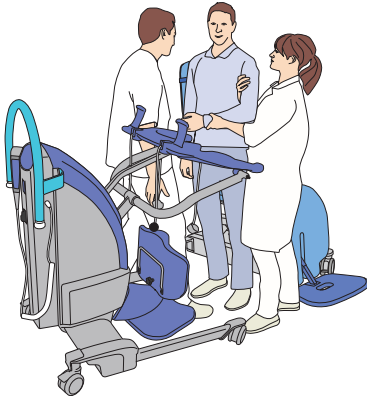

9. If the patient can stand up without a standing or raising aid, support the patient during the movement into a standing position.
10. If using an aid, place the aid in front of the patient, in this example a walking aid. (See Fig. 4)

11. **WARNING**

To avoid falling during patient transfer, always make sure that the brakes on the equipment receiving the patient are applied.

Apply the brakes on the aid.

12. **WARNING**

To avoid the patient from falling or caregiver from being injured, make sure that there are two or more caregivers present during the patient transfer process.

Help the patient to a standing position and complete the transfer according to local routine or according to the aid *IFU*.

NOTE

To help the patient to a standing position, the *Sara Combilizer* can be slowly raised and then tilted towards the transfer side.

13. Support the patient and guide him/her towards the aid. (See Fig. 4)

NOTE

Only transfer a patient to a walking/raising aid when the *Sara Combilizer* is in an upright chair position.

Transfer of Patient from Standing to Sitting Position

For walking/standing and raising aid instructions, see respective aid *IFU*.

Prior to patient transfer make sure that all IV and monitoring lines, drains, fluid bags and catheters attached to the patient have enough slack, to minimise the risk of accidental disconnection during transfer.

Inform the patient about the transfer.

NOTE

The number of caregivers and their positions during the transfer depends on the transfer method being used and the clinical assessment of the patient.

Follow these 17 Steps

Fig. 1

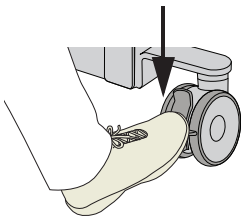

1.

WARNING

To avoid falling during patient transfer, always make sure that the brakes on the equipment receiving the patient are applied.

Apply the brakes on *Sara Combilizer*. (See Fig. 1)

2. Make sure that the *Sara Combilizer* is in an upright and lowest chair position.
3. Fold down the shoulder support on the transfer side.
4. Remove the armrest on transfer side.
5. Move the patient with the aid, close to *Sara Combilizer*.

6.

WARNING

To avoid falling during transfer, always ensure that the brakes are applied on all equipment being used.

Apply the brakes on the aid if an aid is being used.

7. If using an aid, complete the transfer according to local routine or according to the aid *IFU*. (See Fig. 2)
8. Adjust the height on the *Sara Combilizer* to the patient's sitting height.
9. Slightly tilt *Sara Combilizer* towards the transfer side.

Continue with the steps on the next page.

Fig. 3



Fig. 4



10. **WARNING**

To avoid the patient from falling or caregiver from being injured, make sure that there are two or more caregivers present during the patient transfer process.

Support the patient during the movement into a seated position. (See Fig. 3)

11. Slowly lower the *Sara Combilizer* until the patient's feet reaches the floor.
12. Tilt *Sara Combilizer* to a horizontal chair position. Support the patient.
13. Help to rotate the patient to a face forward seated position. (See Fig. 4)
14. Lift up the patient's feet and position them on the foot support.

15. **WARNING**

To avoid falling, make sure that the patient is positioned correctly and that the safety belts are being used, properly fastened and tightened.

Attach and adjust the required safety belts.

16. Attach the armrest and adjust the width and height to fit the patient. See section *Armrest on page 12*
17. Fold up the shoulder support and adjust the width to fit the patient. See section *Shoulder Support on page 16*

Change Position

The *Sara Combilizer* can be set to various positions during use: Stretcher position, Tilt table position, Chair position upright, Chair position tilt back, Tilted position (left and right) and Trendelenburg position, for more detailed information see section *Sara Combilizer Positions on page 11* and the *table on page 44-45*.

Before any position changes are done be sure to read the section *Control Functions on page 22*.

WARNING

To prevent patient from falling or jamming body parts, make sure that hands, legs and feet are kept on equipment.

WARNING

To avoid entrapment/jamming of caregiver's feet when changing to standing position, make sure that the feet are kept clear of the foot plate.

WARNING

To avoid entrapment, make sure to keep the patients hair, arms and feet close to the body and use designated grab supports during any movement.

WARNING

To avoid risk of injury do not place *Sara Combilizer* with patient in head down tilt greater than -15° .

Degree of tilt can be assessed on the tilt angle indicator located under the head section of the *Sara Combilizer*.

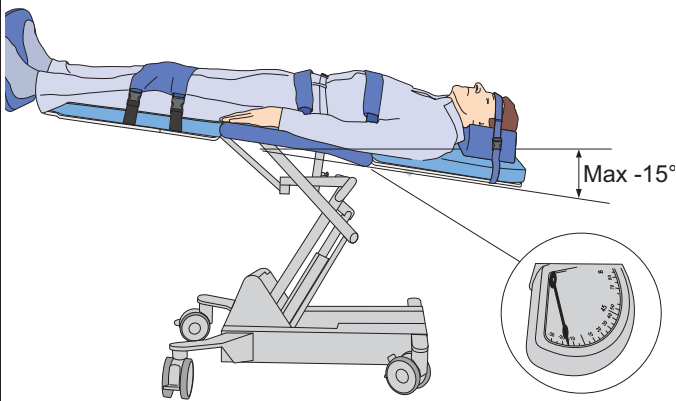

NOTE

The number of caregivers to be present during treatment depend on local routines and patient assessment.

NOTE

The armrests need to be folded down before changing from tilt table to stretcher.

NOTE

During a tilt left/right, the *Sara Combilizer* will stop for 3 seconds when it has reached a horizontal position. Keep the button pressed down to continue the movement.

Prepare for position change

Before any position changes are done, the caregiver must always do the following:

- Inform the patient about the planned activity. (This applies to unconscious patients as well).
- Adjust the *Sara Combilizer* to fit the patient's needs. See section *Product Description/Functions on page 10*.
- Check that the knee belts are attached loose when changing from stretcher to chair position.
- Check that there is enough space around the *Sara Combilizer* to perform the position change.
- Check that the brakes are applied.

During treatment

- Make sure that the patient is repositioned according to applicable clinical protocol.
- Prior to patient transfer make sure that all IV and monitoring lines, drains, fluid bags and catheters attached to the patient have enough slack, to minimise the risk of accidental disconnection during procedures.

Check patient after position change

After the position change is completed, the caregiver must always:

- Check that the safety belts are not too tight or too loose.
- Adjust the *Sara Combilizer* to fit the patient. See section *Product Description/Functions on page 10*.

Change of mode

To change the mode two procedures can be used:

- Using "change of mode" button on control panel.
- Using buttons on hand control followed by selected change of mode button on control panel.

See section *Change of Mode on page 23*.

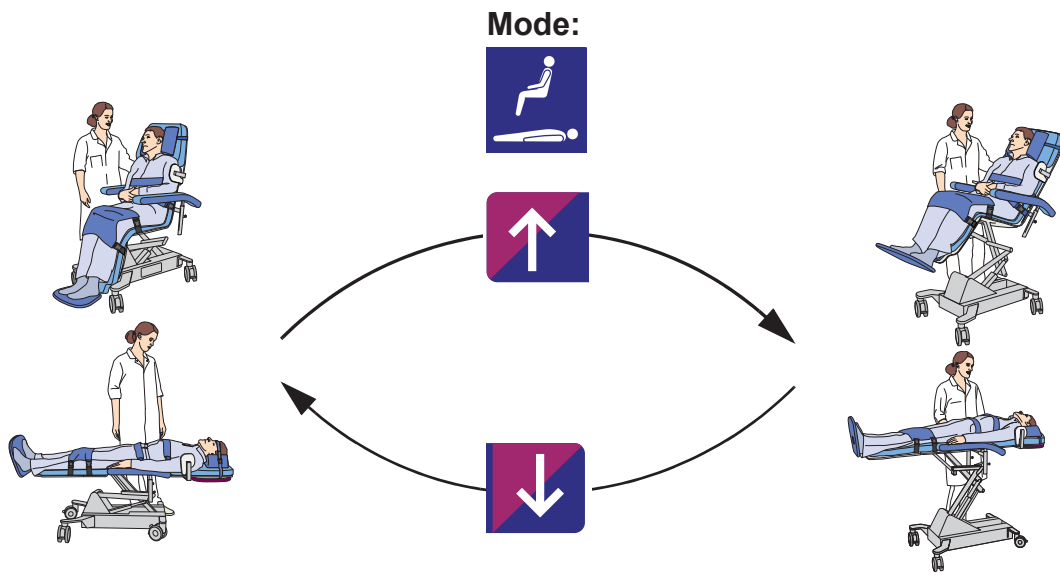

Chair and Stretcher position - Up and Down

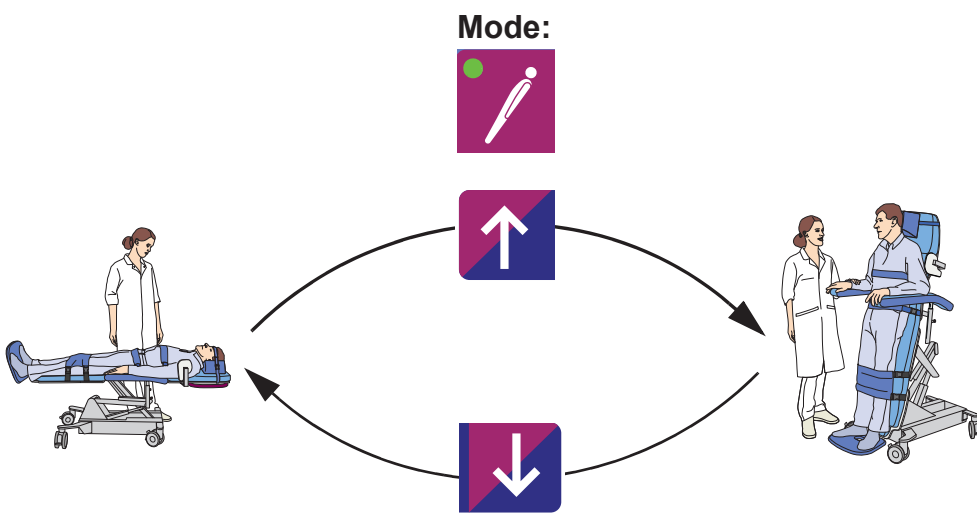

Stretcher to tilt table/Tilt table to stretcher

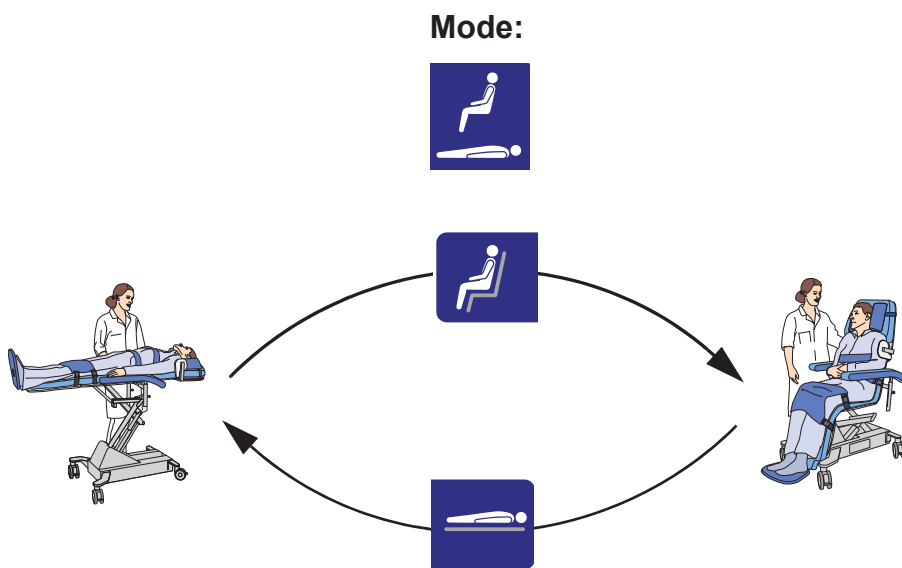

Stretcher to chair/Chair to stretcher

Mode:



Tilt chair back/Tilt chair upright

Mode:

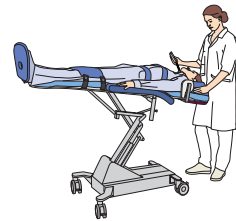

Stretcher to Trendelenburg/Trendelenburg to stretcher

Mode:

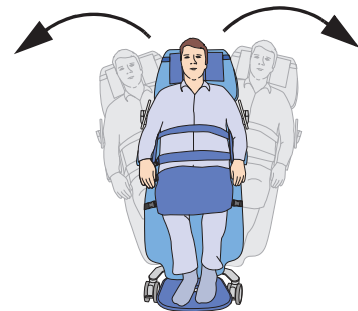
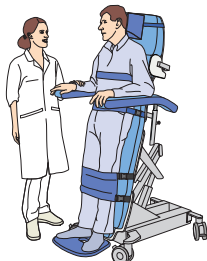
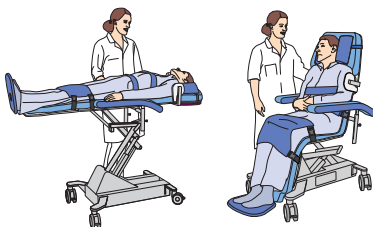

Tilt left or right

Transport

Fig. 1

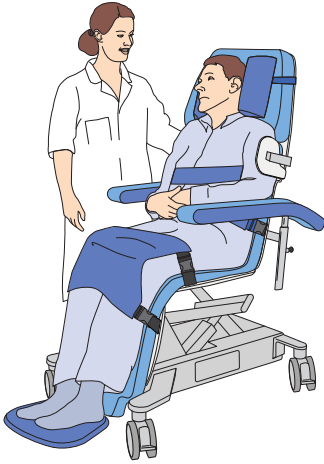

With patient (4 steps)

1. Make sure that the required safety belts are attached. See section *Safety Belts* on page 25.

2. **WARNING**

To prevent patient from falling or jamming body parts, make sure that hands, legs and feet are kept on equipment.

Position the patient's feet and hands within the chair. (See Fig. 1)

3. Make sure that the foot support is adjusted to fit the patient's length. See section *Foot Support* on page 14.

4. **WARNING**

To avoid entrapment, make sure the path of the movement is free from obstacles.

WARNING

To avoid patient body injury/jamming be aware of limited sight during transport.

Make sure that the transport path is free of obstacles and that the caregiver's feet are kept away from the castors.

NOTE

It's recommended to use the upright chair position when transporting patients. Make sure that the chair is in its lowest position. It is recommended that the *Sara Combilizer* only is used for short distance transport.

Fig. 2

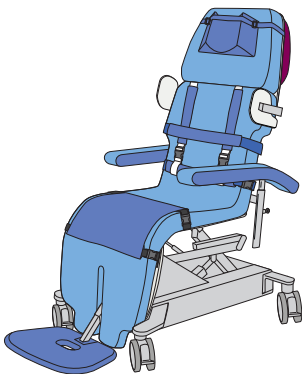

Without patient (3 steps)

1. When transporting the *Sara Combilizer* without a patient, place the *Sara Combilizer* in a upright chair position. (See Fig. 2)
2. Lower the chair as much as possible.
3. Make sure that the transport path is free of obstacles and that the caregiver's feet are kept away from the castors.

Cleaning and Disinfection Instructions

The following processes are recommended, but should be adapted to comply with the local or national guidelines (Decontamination of Medical Devices) which may apply within the Healthcare Facility or the country of use. If you are uncertain, you should seek advice from your local Infection Control Specialist.

The *Sara Combilizer* should be routinely cleaned and disinfected between patients and at regular intervals while in use; as is good practice for all reusable medical devices.

If you have any questions regarding cleaning and disinfecting the equipment, or wish to order disinfectant fluid, contact Arjo Customer Service. See section, *Parts and Accessories*. Make sure to have the Safety Data Sheets (SDS) available for the disinfectants being used.

WARNING

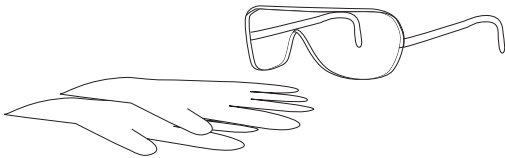

To avoid eye and skin damage, always use protective glasses and gloves. If contact occurs rinse with plenty of water. If eyes or skin becomes irritated, contact a physician. Always read the instructions for use and material safety data sheet of the disinfectant.

WARNING

To prevent cross-contamination, always follow the disinfection instructions in this *Instructions for Use*.

WARNING

To avoid cross-contamination, be aware that alcohol has limited disinfection effect on bacterial and fungal spores.

WARNING

To avoid eye or skin irritation, never disinfect in the presence of a patient.

CAUTION

To avoid damage on the equipment only use Arjo branded disinfectants, Isopropanol or Sodium Hypochlorite.

CAUTION

Do not clean:

- in wash tunnel
- with pressure washer

CAUTION

Failure to wash off cleaning/disinfection agent may result in the accumulation of reagent that could damage the polyurethane coating.

Verified Detergents/Disinfectants

- Arjo Clean
- Arjo General Purpose Disinfectant
- Arjo Disinfectant Cleanser IV
- Arjo All Purpose Disinfectant
- Arjo CenKleen IV
- Alcohol (Isopropanol 70%)
- Sodium Hypochlorite 0,1-0,5%
- Mild neutral detergent

Accessories for Cleaning/Disinfection

- Protective glasses
- Protective gloves
- Spray bottle with water
- Protection plug (for hand control connection)
- Disposable towels

Additional Accessories for Between Patient Cleaning/Disinfection

- Spray bottle with mild neutral detergent
- Spray bottle with approved disinfectant

Additional Accessories for Regular Cleaning/Disinfection

- Spray bottle with Arjo recommended branded disinfectant
- Brush
- Washing machine
- Tumble dryer
- Washing detergent

These accessories are also needed for cleaning after a contaminated or before an immune compromised patient.

General Instructions for Cleaning and Disinfection

- Make sure that the cleaning and disinfection solutions are mixed according to the *IFU* or the instructions labelled on the disinfection bottle.
- Make sure that the detergent/disinfectant reaches all parts of the equipment.
- When wiping the *Sara Combilizer*, always start from the top and work downwards. (See Fig. 1)

Between patients: Hand control, driving handle, head mattress, shoulder supports, armrests, body mattress, belts including attachment straps and foot support.

Regular Cleaning: Hand control, driving handle, front of back support plate, shoulder supports, armrests, front of seat and foot support plate, back of support plate, lifting mechanism, chassis, foot support, and castors.

- Clean detached parts separately and always place them on a clean surface.
- Change the disposable towel after each item to avoid cross-contamination.

Fig. 1

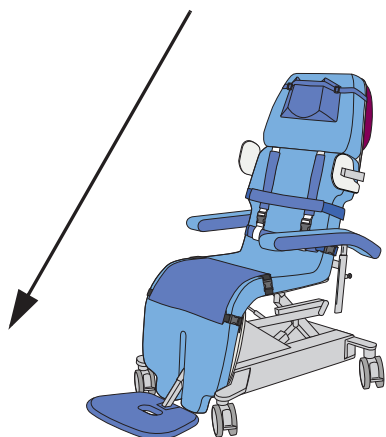

Cleaning/Disinfection Between Patients

Follow these 21 steps

NOTE

When cleaning after a contaminated patient or before an immune compromised patient follow instruction in section *Cleaning/Disinfection Regular*

Fig. 1

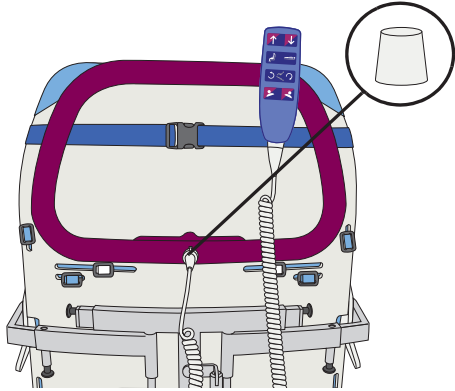

Preparation (step 1-4)

1. Place the *Sara Combilizer* in a chair position (normal mode).
2. Adjust the height of the chair to an ergonomic working height.
3. Make sure either the protection plug or the hand control contact plug is correctly inserted in the connection point on the driving handle. (See Fig. 1)
4. Remove the pillow and all safety belts.

Removal of visible contaminations (step 5)

5. Wet a disposable towel with water and remove visible stains and soil.

Front of *Sara Combilizer*, Pillow and Safety Belts

Cleaning (step 6-11)

6. Spray detergent on all parts of the *Sara Combilizer* that have been in contact with the patient.
7. Start with the front and clean the pillow and the safety belts separately.
8. Wet a new disposable towel with water and remove all traces of detergent.
9. If the detergent cannot be removed, spray with water and wipe off with a disposable towel.
10. Repeat until all of the detergent has been removed.
11. Let all parts dry.

Continue with the steps on the next page.

Fig. 2

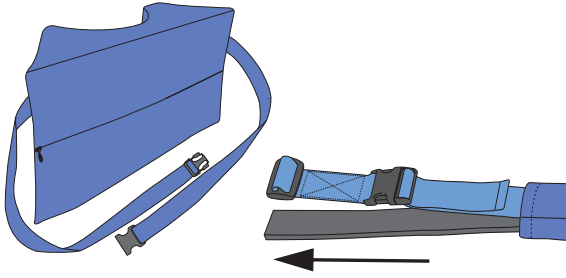

Disinfection (step 12-14)

12. Spray with approved disinfectant on all parts of the *Sara Combilizer* that have been in contact with the patient. (See Fig. 2)
13. Allow the approved disinfectant to stay on the parts according to the recommended disinfection time, labelled on the bottle, or at least 2 minutes.
14. Wipe off all traces of Isopropanol using disposable towels.

Fig. 3

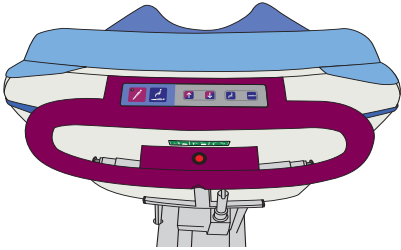

Transport Handle Including Control Panel and Hand Control

Cleaning (step 15-16)

15. Spray detergent on the transport handle, control panel and hand control. (See Fig. 3 and 4)
16. Repeat cleaning steps 8-11.

Fig. 4

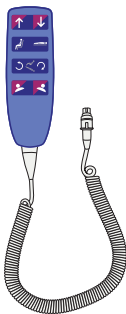

Disinfection (step 17-18)

17. Spray approved disinfectant on the transport handle, control panel and hand control.
18. Repeat disinfection steps 13-14.

Reassembly (step 19-21)

19. Attach the pillow and all safety belts on the disinfected *Sara Combilizer*. See section *Product Description/ Functions* and *Safety Belts*.
20. Remove the protection plug from the connection point and connect the hand control (if applicable).
21. Put the protection plug in a safe place for next cleaning/ disinfection occasion.

Fig. 1

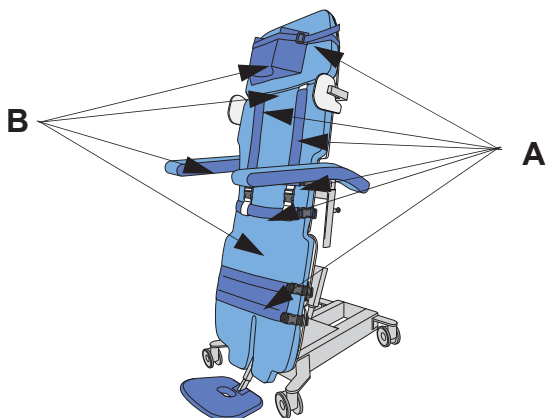

Fig. 2

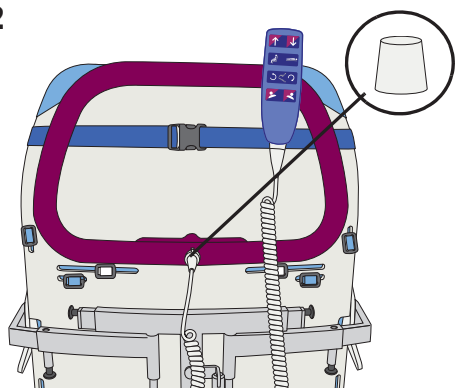
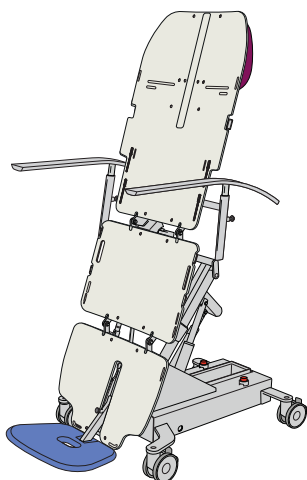

Fig. 3



Cleaning/Disinfection Regular

This procedure must be carried out at least each quarter or when the *Sara Combilizer* has been contaminated or before use by an immune compromised patient.

Follow these 37 steps

Preparation (step 1-5)

1. Place the *Sara Combilizer* in a tilt table position (standing mode).
2. Adjust the height to an ergonomic working height by raising the table to 45-70°.
3. Detach the safety belts including belt attachment straps. (See Fig. 1A)
4. Remove the pillow, head mattress, body mattress and armrests (covers and foam). (See Fig. 1B)
5. Make sure either the protection plug or the hand control contact plug is correctly inserted in the connection point on the driving handle. (See Fig. 2)

Removal of visible contamination (step 6-10)

6. Wet a disposable towel with water and remove visible stains and soil on the *Sara Combilizer* and all detached parts.
7. If heavily contaminated please use brush and towels to remove all visible contamination.
8. Detachable parts may be rinsed under flowing lukewarm water.
9. Wash the covers according to section *Washing and drying of Textiles*.
10. Wash the safety belts and belt attachment straps according to section *Washing and drying of Textiles*.

Front of Sara Combilizer, Hand Control and Belt Padding

Cleaning (step 11-15)

11. Spray with Arjo verified detergent on all front parts of the *Sara Combilizer*, on the hand control and on the belt padding.
12. Wet a disposable towel with water and remove all traces of the Arjo verified detergent. (See Fig. 3)
13. If the Arjo verified detergent cannot be removed, spray with water on the affected part and wipe it off with disposable towels.
14. Repeat until all of the detergent have been removed.
15. Let all parts dry.

Continue with the steps on the next page.

Fig. 4

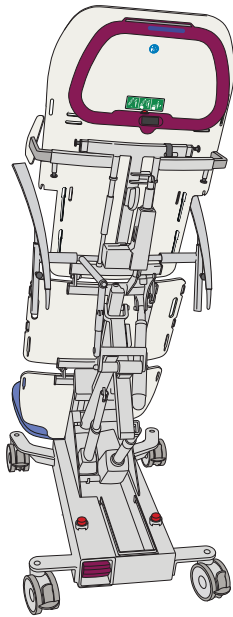

Fig. 5

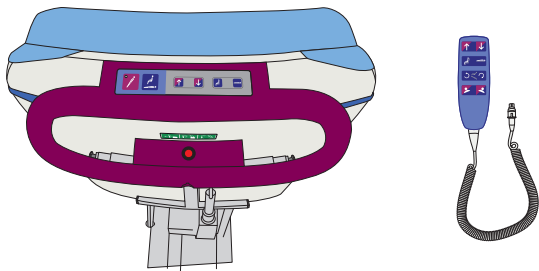
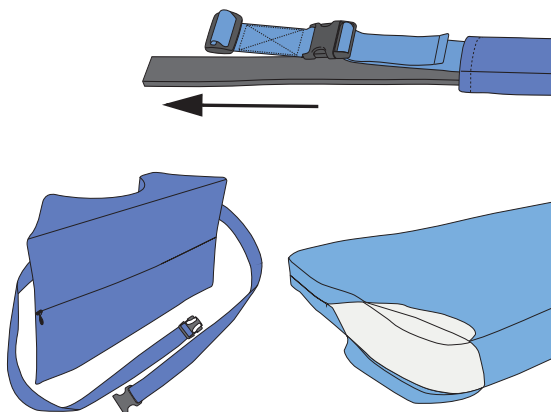

Fig. 6



Disinfection (step 16-21)

16. Repeat spraying on all parts and on the hand control with the Arjo verified detergent.
17. Allow the disinfectant to stay on the parts according to the recommended disinfection time labelled on the bottle.
18. Remove all traces of disinfectant, using new wet disposable towel.
19. If the disinfectant cannot be removed, spray with water on the affected part and wipe it off with disposable towels.
20. Repeat until all of the detergent has been removed.
21. Let all parts dry.

Back of Sara Combilizer

Cleaning (step 22-23)

22. Spray the Arjo verified detergent on all parts of the back of the *Sara Combilizer*. (See Fig. 4 and 5)
23. Repeat cleaning steps 10 - 13. Make sure to use new disposable towels.

Disinfection (step 24-25)

24. Repeat spraying the Arjo verified detergent on all parts of the *Sara Combilizer*.
25. Repeat disinfection steps 15 - 19. Make sure to use new disposable towels.

Washing and Drying of Textiles (steps 26-29)

26. Remove the covers from the safety belts, armrests, pillow, head and body mattresses. (See Fig. 6)
27. Store the padding and foam in a clean and dry area during the washing.
28. Wash the textile as follows:
 - Covers: Wash with zippers open at 70°C (158°F) at normal wash.
 - Safety belts with belt attachment straps:
 - Wash at 60°C (140°F) at normal wash.
29. Tumble dry the textiles as follows:
 - Covers: Tumble dry inside out, with the zippers open at a maximum of 70°C (158°F).
 - Safety belts with belt attachment straps:
 - Tumble dry with the buckles at a maximum of 60°C (140°F).

Continue with the steps on the next page.

Fig. 7

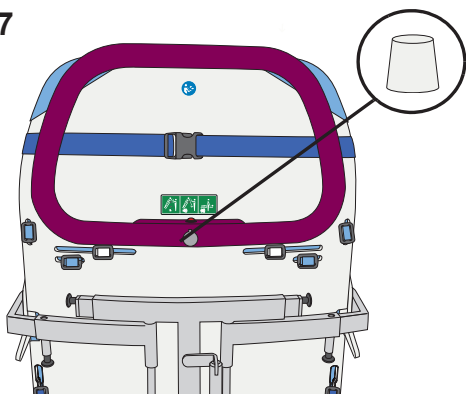
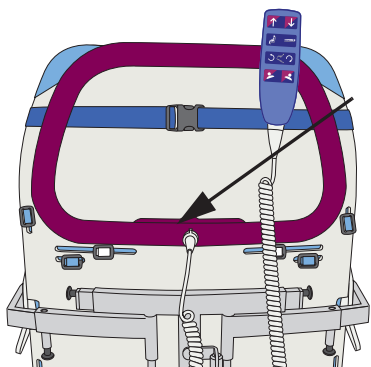

Fig. 8



Reassembly (steps 30-39)

30. Visually inspect all padding, foams, covers, safety belts and belt attachment straps.
31. Insert the safety belts in the safety belt covers.
32. Insert the padding below the belt webbing (padding closest to patient's body).
33. Insert the foam in the mattress, pillow, armrests and safety belt covers.
34. Attach the mattresses, pillow, armrests, belt attachment straps and the safety belts on the disinfected *Sara Combilizer*.
35. Remove the protection plug from the connection point (If applicable). (See Fig. 7)
36. Put the protection plug in a safe place for next cleaning/disinfection occasion.
37. Connect the hand control. (See Fig. 8)
38. Lower the *Sara Combilizer* from a tilt table position to a stretcher position.
39. Change to Normal mode and place the *Sara Combilizer* in a chair position.

NOTE
Use a mild laundry detergent without bleaching agent.

NOTE
Do not mangle the safety belts or mattress covers.

NOTE
Do not use any spot stain remover products.

NOTE
Do not tumble dry belt above temperature 60°C (140°F) or mattress/belt covers above 70°C (158°F).

NOTE
If the covers have been extremely soiled it is possible to occasionally wash them at maximum 80°C (176°F).

Battery Instructions

WARNING

To avoid bodily injury, do NOT crush, puncture, open, dismantle or otherwise mechanically interfere with the battery.

- Should the battery casing crack and cause contents to come in contact with skin or clothing, rinse immediately with plenty of water.
- If contents come in contact with the eyes, rinse immediately with plenty of water and seek medical attention.

Inhalation of the contents can cause respiratory irritation. Provide fresh air and medical attention.

- Be careful not to drop the battery.
- Contact the appropriate local authority for advice when disposing of batteries.
- Check label on the battery.

Storage of Batteries

- The battery is delivered charged but we recommend you recharge the battery when received due to a slow self discharge.
- This battery will slowly self discharge when not used.
- A battery not in use should be stored in a temperature range of -0°C (32°F) to + 30°C (86°F).
- For maximum battery performance do not store the battery above 50°C (122°F).

Charging Intervals

- To prolong the life of the battery, charge it at regular intervals, i.e. every night.
- It is recommended to use two batteries, one in operation and one as a stand-by in the charger.
- It's recommended that a battery not in use is left in the charger. There is no risk of overcharging the battery.

Battery Service Life

If using a freshly charged battery and the battery indicator starts to sound after only a few activities are carried out, it is time to order a new battery.

Low Charge Warning

A buzzer sound will go off when the battery reaches a low charge. The battery should then be recharged as soon as possible.

Installation of Charger

See *NEA 8000 Battery Charger IFU*.

How to Charge the Battery

See *NEA 8000 Battery Charger IFU*.

Care and Preventive Maintenance

Sara Combilizer is subject to wear and tear, and the following actions must be performed when specified to make sure that the product remains within its original manufacturing specification.

WARNING

To avoid malfunction resulting in injury make sure to conduct regular inspections and follow the recommended maintenance schedule. In some cases due to heavy use of the product and exposure to aggressive environment more frequent inspections should be carried out. Local regulations and standards may be more stringent than the recommended maintenance schedule.

WARNING

To avoid injury to both the patient and the caregiver, never modify the equipment or use incompatible parts.

NOTE

Product cannot be maintained and serviced while in use with the patient.

PREVENTIVE MAINTENANCE SCHEDULE: *Sara Combilizer*

CAREGIVER OBLIGATIONS Action/Check	Before each use	Between patients	Every week	Each quarter	Once a Year	Every 5th year
Cleaning/Disinfection		X		X		
Visually check safety belts	X					
Visually check all exposed parts			X			
Visually check hand control, cable and control panel			X			
Visually check the tilt angle indicator			X			
Clean and inspect castors			X			
Visually check the mattresses, armrest cushions and head pillow			X			
Visually check the battery			X			
Perform functionality test			X			
Test emergency stop function			X			
Test pinch protection bar function			X			
Replace safety belts						X
Replace textile covers						X
Yearly checks by qualified service personnel only					X	

Caregiver Obligations

Caregiver obligations shall be carried out by personnel with sufficient knowledge about the *Sara Combilizer*, following the instructions in this *IFU*.

If the product does not work as intended, contact qualified service personnel.

Before Each Use

Visually check safety belts

Before each use of the *Sara Combilizer* the safety belts must be checked as follows:

Place the *Sara Combilizer* in tilt table end position (75°).

(See Fig. 1) Check the following:

- The complete length of all the safety belts for fraying, cuts or loose stitching.
- That the buckles are undamaged and that they can be opened and closed.
- That the attachment straps are safely attached to the *Sara Combilizer*.

If the belts are damaged, do not use the belts. New belts must be ordered.

Between Patients

Cleaning/Disinfection

Sara Combilizer should be disinfected after each use.

See section, *Cleaning/Disinfection Between Patients* on page 49.

Every Week

Every week the following checks must be carried out:

NOTE

If any damage is found replace the damage parts immediately. Contact qualified personnel if necessary

Visually check all exposed parts

Place the *Sara Combilizer* in tilt table end position (75°).

(See Fig 1) Check the following for damage, cracks or sharp edges that could cause injury:

- Foot support
- Armrests
- Shoulder supports
- Transport handle on the back support plate

Continue with the steps on the next page

Fig. 1

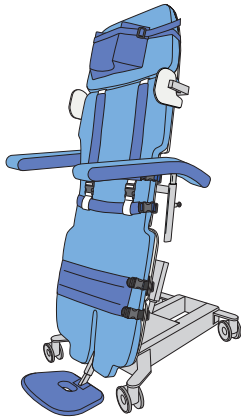
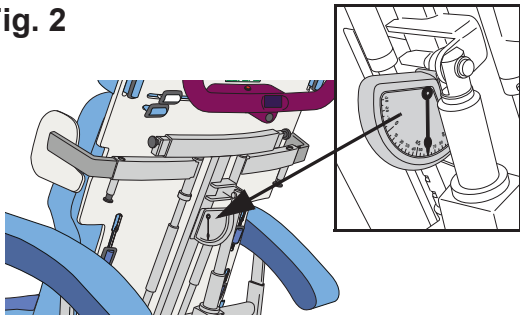

Fig. 2



Visually check the tilt angle indicator

Check the tilt angle indicator as follows:

- Make sure that the *Sara Combilizer* is in tilt table end position. The tilt angle indicator shall display $75^{\circ}\pm 5^{\circ}$. (See Fig. 2)
- Lower the tilt table and verify that the needle on the tilt angle indicator moves freely.
- Position the *Sara Combilizer* in a horizontal stretcher position. The tilt angle indicator shall display $0^{\circ}\pm 5^{\circ}$.

NOTE

Tilt Angle Indicator does not work when *Sara Combilizer* is side tilted.

Fig. 3

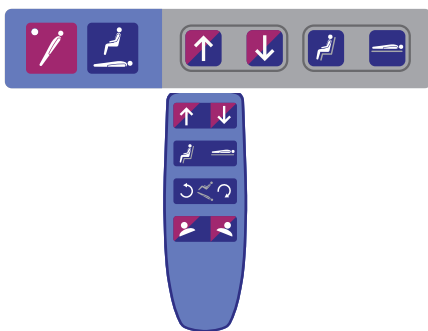

Visually check the hand control, cable and control panel

Check the hand control, cable and control panel as follows:

- Check for cracks or sharp edges that could cause injury or that could make the equipment difficult to clean/disinfect. (See Fig. 3)
- Check that the displays on the hand control and control panel are attached and undamaged.

Fig. 4

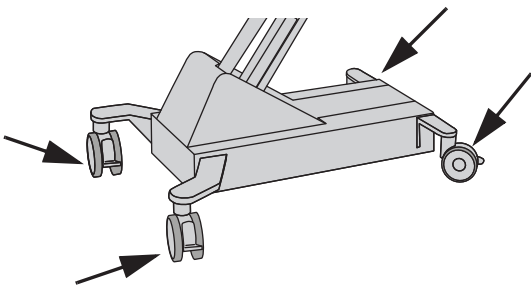

Clean and inspect castors

Clean and inspect castors as follows:

- Check castors and remove any visible dirt.
- Check the movement of the castors and make sure that they move and swivel freely. (See Fig. 4)
- Apply one brake at a time. With the brake applied, the castor shall not move forward when the *Sara Combilizer* is being pushed. Repeat on all four brakes.
- Apply all four brakes. Push the *Sara Combilizer* in all directions. It should not move when being pushed.

Continue with the steps on the next page

Fig. 5

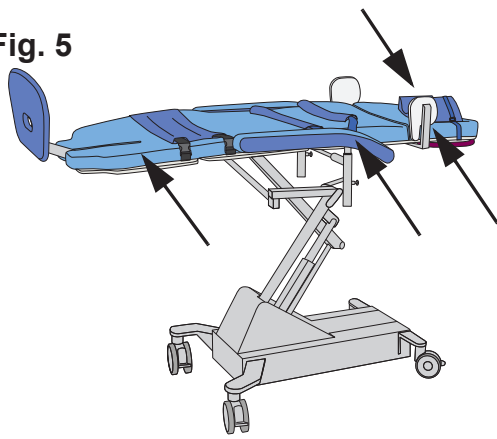

Visually check the mattresses, armrest cushions and pillow

Check the mattresses, armrest cushions and pillow as follows:

- Check that there are no holes, cracks or tears that could result in difficulties cleaning/disinfecting the fabric. **(See Fig. 5)**
- Check if there is any serious discolouration/contamination.
- Check that all straps for attaching mattresses and pillow are undamaged and still connected to the mattresses. There shall be no fraying, cuts or loose stitching.
- Check that all slip locks are undamaged.

Fig. 6

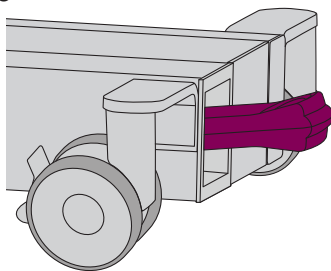

Visually check the battery

Check the battery as follows:

- Check that there are no cracks in the casing or damage/slack on the battery connection plug. **(See Fig. 6)**
- Check that there is no leakage from the battery.
- Check the spare battery in the same way.

Fig. 7

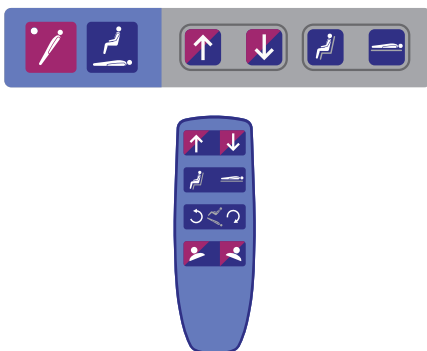

Perform functionality test

Perform a functionality test as follows:

- Go through the functions on the hand control and control panel. **(See Fig. 7)**
- Test all movements from start to end position. All buttons must be working according to section *Control Functions*.
- Check for abnormal sounds during the movements.
- If the hand control does not work, replace it.
- If the control panel does not work as intended or abnormal sounds occurs, contact qualified personnel.

Continue with the steps on the next page

Fig. 8

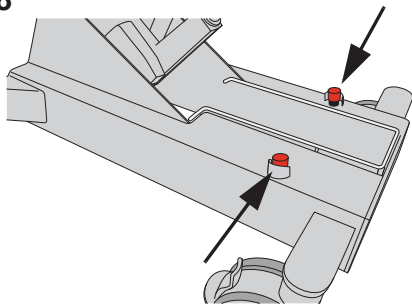

Test emergency stop function

Test the emergency stop function as follows:

- Activate one of the emergency stop buttons. **(See Fig. 8)**
- Check that there are no movements when the buttons on hand control or control panel are being pushed.
- Reset the emergency stop.
- Check that there is movement when the buttons on hand control or control panel are being pushed.
- Repeat above test for the second emergency stop button.

Fig. 9

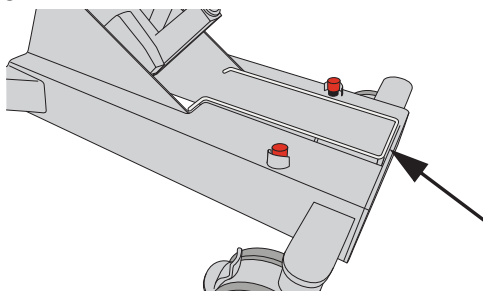

Test pinch protection bar function

Test the pinch protection bar function as follows:

- Press down and hold the “Down” button on the hand control.
- Push down the pinch protection bar located between the two chassis beams. **(See Fig. 9)**
- Make sure that the *Sara Combilizer* stops and no further movements occurs.
- Release the pinch protection bar.
- Press down and hold the “Down” button.
- Make sure that the *Sara Combilizer* moves downwards.

Yearly Checks by Qualified Personnel only

The *Sara Combilizer* must be serviced once a year in accordance with the *Maintenance and Repair Manual*.

WARNING

To avoid injury and/or unsafe product, the maintenance activities must be carried out at the correct frequency by qualified personnel using correct tools, parts and knowledge of procedures. Qualified personnel must have documented training in maintenance of this device.

NOTE

All Caregiver Obligations are to be checked when performing the Qualified Personnel Service. For details, see separate service instructions.

Troubleshooting and Alarms

Troubleshooting

Always make sure that the *Sara Combilizer* battery is charged or changed and that it is correctly inserted before taking further actions. After each step check if the problem still persists before going to the next step.

PROBLEM (Using <i>Sara Combilizer</i>)	ACTION (Perform the actions below in the described order.)
Hand control is not responding.	<ol style="list-style-type: none"> 1. Make sure that there are no obstructing objects around, above or under the <i>Sara Combilizer</i>. 2. Check that the patient weight does not exceed 200 kg (440 lbs). 3. Make sure that both emergency stops are inactivated. 4. Remove hand control connection and reinsert plug so that it is fully inserted. 5. Check that the pinch protection bar is not activated. 6. Disconnect the hand control cable and try to move the stretcher/chair/tilt table via the control panel. 7. If control panel is working, replace the hand control. 8. If the problem persists, remove the patient. If needed use the emergency lowering box. 9. Call for qualified personnel.
Change of mode on control panel It's not possible to change mode.	<ol style="list-style-type: none"> 1. Make sure that there are no obstructing objects around, above, or under the <i>Sara Combilizer</i>. 2. Check that the patient weight does not exceed 200 kg (440 lbs). 3. Check that the pinch protection bar is not activated. 4. Make sure that both emergency stop buttons are inactivated. 5. Make sure that the <i>Sara Combilizer</i> is in the correct position by pressing "Change of mode" button until the LED light has stopped flashing and a fixed light (Standing mode) or turned off (Normal mode) light has been received. 6. If the problem persists, remove the patient. If needed use the emergency lowering box. 7. Call for qualified personnel.
Stretcher is not locked after tilt table release lowering and shift mode is not working.	<ol style="list-style-type: none"> 1. Press firmly the transport handle/stretcher head end downward 2. If the problem persists, remove the patient. 3. Call for qualified personnel.

PROBLEM (Using <i>Sara Combilizer</i>)	ACTION (Perform the actions below in the described order.)
Transport The chair is hard to manoeuvre during transport.	<ol style="list-style-type: none"> 1. Make sure that there are no obstructing objects around or under the <i>Sara Combilizer</i>. 2. Release all brakes. 3. Make sure all castors are clean and free from any obstructing object. 4. Make sure all castors roll and swivel freely. 5. If the problem persists, remove the patient. 6. Call for qualified personnel.
The brakes are not working.	<ol style="list-style-type: none"> 1. Check that there are no obstructing objects stuck in the castors/brakes and clean if necessary. 2. If the problem persists, remove the patient. 3. Call for qualified personnel.
Left-right tilt does not stop at a horizontal position.	<ol style="list-style-type: none"> 1. Push one of the side tilt buttons so that the stretcher passed over the horizontal position until it stops on the other side. 2. Push the other side tilt button: The stretcher will stop at the horizontal position. 3. If the stretcher does not stop in the sideways horizontal position remove the patient. 4. Call for qualified personnel.
The left-right tilt function does not work in Standing Mode.	<ol style="list-style-type: none"> 1. Check that the foot support is not touching the floor. 2. If the foot support is touching the floor, <i>Sara Combilizer</i> should be lowered and the foot support adjusted to its highest innermost position. 3. If the problem persists remove the patient. 4. Call for qualified personnel.
Emergency function box functions do not work.	<ol style="list-style-type: none"> 1. Remove the patient. 2. Call for qualified personnel.

Alarms

ALARMS/SOUNDS	ACTION
Sound indication A pulsating buzzer sound is heard when pressing a button on the control panel or the hand control.	The battery level is low. <ol style="list-style-type: none"> 1. Change to a fully charged battery. 2. If the problem persists, remove the patient. 3. Call for a qualified personnel.

Technical Specifications

General	
Safe working load (SWL) = Maximum total load	200 kg (440 lbs)
Maximum patient weight	200 kg (440 lbs)
Max total weight (<i>Sara Combilizer</i> + patient)	315 kg (694 lbs)
Weight of <i>Sara Combilizer</i>	115 kg (254 lbs)
Model and Type	APA1 XXX XX (XXX= Variant, XX = Country Specific) APA1 000 WW (000=Standard, WW = World Wide)
Degree of protection IP: Ingress Protection X: The protection against contact and ingress of objects is not specified for this product. 4: Water splashing against the product from any direction does not affect safety or essential performance	IPX4
Degree of protection - Hand Control IP: Ingress Protection X: The protection against contact and ingress of objects is not specified for this product. 6: Powerful water jets against the product from any direction does not affect safety or essential performance	IPX6
Medical equipment	Type B 
Protection class	Battery powered
Operating force: Push buttons - Control Panel	2 N
- Hand control	4 N
- Tilt Table Release Button	5 N
- Emergency Stop	18 N
- Emergency Function Box	18 N
Brakes	52 N
Lift nominal voltage	24V DC
Battery part number	NEA0100-083
Battery type	NiMH (Nickel-metal hydride)
Battery capacity	2,5Ah
Battery voltage	24V DC
Battery Charger part number	NEA 8000-WW, NEA 8000-AU
Maximum duty cycle - up/down actuator	10% (2 minutes on, 18 minutes off)
Maximum duty cycle - chair/stretchers actuator	10% (2 minutes on, 18 minutes off)
Maximum duty cycle - tilt back/upright actuator	10% (2 minutes on, 18 minutes off)
Maximum duty cycle - tilt left/right actuator	10% (2 minutes on, 18 minutes off)

General	
Sound Level	50 dB (A)
Hand control cable	50 cm (19 5/8") coiled 150 cm (59") stretched to a maximum
Pollution degree	2
Operating range of the tilt angle indicator	-30° to 90°
Accuracy and precision of the tilt angle indicator	5°
Max power	200 W

Degree of fire protection	According to standard EN 1021-1 and EN 1021-2
Material:	
Safety belt	Polyester (PES)
Mattress, cushion and head pillow foam	Polyurethane (PU)
Mattress, cushion and head pillow cover	Polyester fabric with polyurethane coating
Belt padding and foot support blocks	Polyethylene (PE)

Component Weights	
Weight foot support	5,8 kg (12,8 lbs)
Weight shoulder support	0,9 kg (2,0 lbs)
Weight armrest	3,1 kg (6,8 lbs)
Weight textile kit	6,1 kg (13,4 lbs)

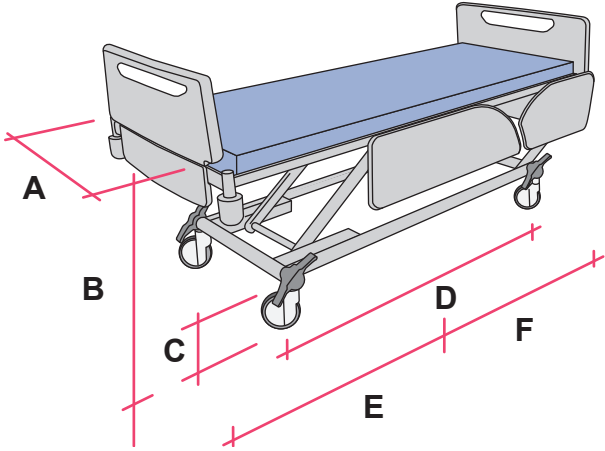
Allowed Combination	
<i>Sara Combilizer</i> integrates with the following Arjo products.	Maxi Sky 440, Maxi Sky 600, Maxi Sky 1000, Maxi Sky II, Maxi Move with extra low castors, Walker, Sara Plus, Concerto, Carevo, Over bed Table PT10, PT11 and OBT
Sliding Aids	MaxiSlide sheets, MaxiSlide Flites, MaxiTube Flites, MaxiTransfer, MaxiRoll and Maxi Air.
Dimension requirements when using lateral transfers with bed frames:	
<p>A: The width of the bed/stretcher must be a minimum of 510 mm (20 1/8") including side rails.</p> <p>B: The height of the lying surface must be within 560 mm (22") to 980 mm (35 5/8").</p> <p>C: There must be a minimum of 170 mm (6 3/4") free space between the floor and the bed chassis for the <i>Sara Combilizer</i> castors to fit.</p> <p>D: There must be a minimum of 910 mm (35 3/4") free space between the head end and foot end castors.</p> <p>E: The distance from the foot end to the middle of the bed must be at 535 mm (21 1/8").</p> <p>F: The distance from the head end to the middle of the bed must be at 375 mm (14 3/4").</p>	 <p>The diagram shows a hospital bed from a side perspective. Red dimension lines with arrows indicate the following measurements: <ul style="list-style-type: none"> A: The width of the bed including side rails. B: The height of the lying surface. C: The clearance between the floor and the bed chassis. D: The clearance between the head and foot end castors. E: The distance from the foot end to the middle of the bed. F: The distance from the head end to the middle of the bed. </p>
No other combinations are allowed.	

Operating, transport and storage	
Temperature	+10°C to + 40°C (+50°F to +104°F) Operating -10°C to +50°C (+14°F to +122°F) Transport -10°C to +50°C (+14°F to 122°F) Storage
Humidity	20-80% Rh at +30°C (+86°F) Operating 20-80% Rh at +30°C (+86°F) Transport - No condensing 20-80% Rh at +30°C (+86°F) Storage - No condensing
Atmospheric pressure	800 hPa to 1060 hPa Operating 800 hPa to 1060 hPa Transport 800 hPa to 1060 hPa Storage

Recycling	
The device should be recycled according to national regulations.	
Package	Wood and corrugated cardboard, Recyclable

End of Life Disposal of Sara Combilizer	
<ul style="list-style-type: none"> • All batteries in the product must be recycled separately. Batteries are to be disposed in accordance with national or local regulations. • Slings including stiffeners/stabilizers, padding material, any other textiles or polymers or plastic materials etc. should be sorted as combustible waste. • Lift systems having electrical and electronic components or an electrical cord should be disassembled and recycled per Waste of Electrical and Electronic Equipment (WEEE) or in accordance with local or national regulation. • Components that are primarily made up of different kinds of metal (containing more than 90% metal by weight) for example sling bars, rails, upright supports, etc., should be recycled as metals. 	

Dimensions

Measurements in mm and inches (“)

Measuring tolerances:

>200 mm ± 20 mm

≤ 200 mm ± 5 mm

Angles $\pm 2^\circ$

Length and width of stretcher

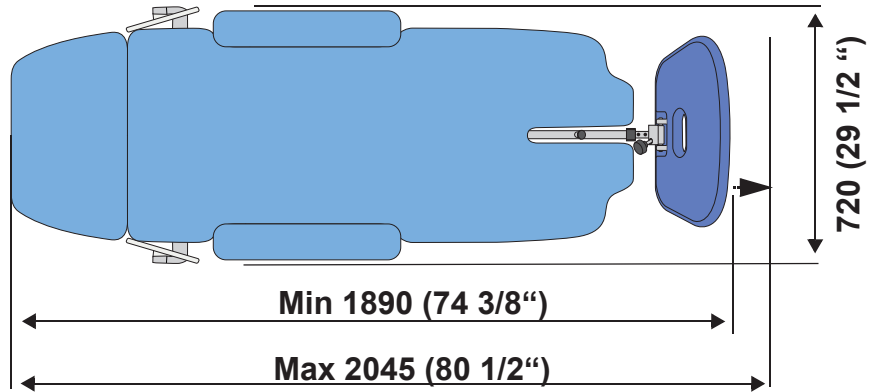

Max. and min. height of stretcher

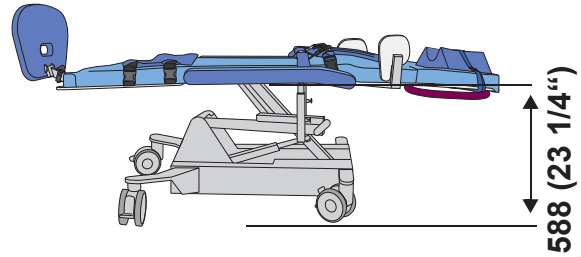
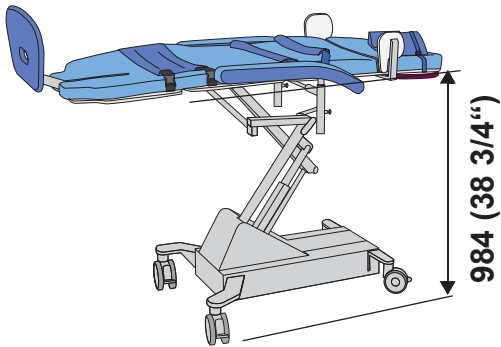

Max. height and depth of tilt table

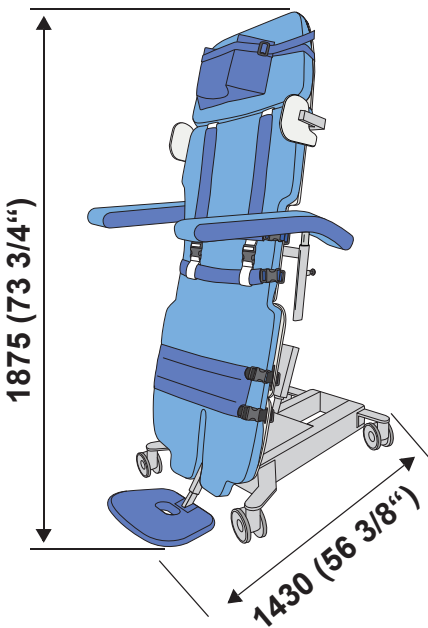

Tilt angle up/down

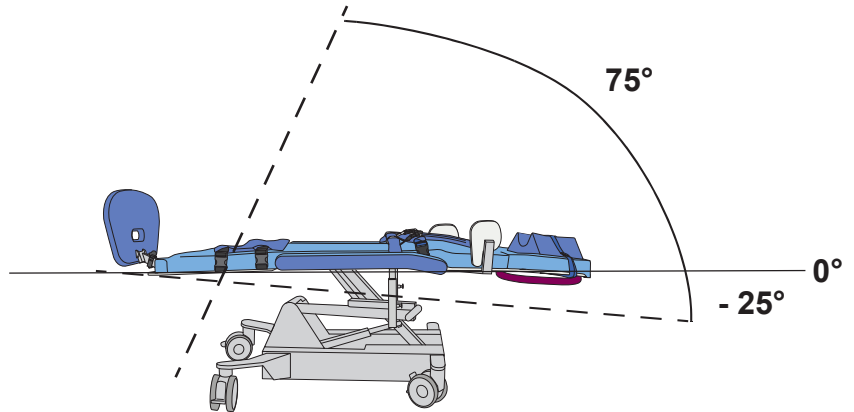

Length, width and height of chassis

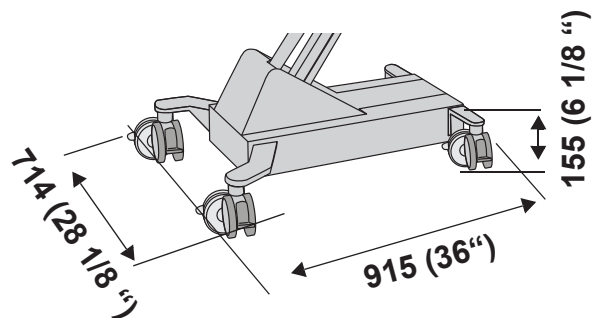

**Max and min height of chair
Width arm rests**

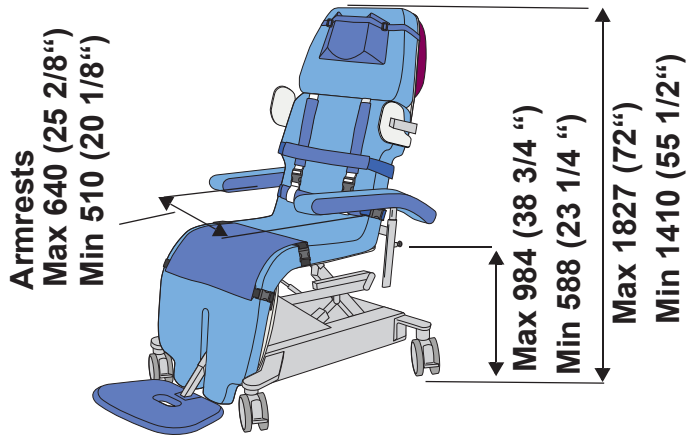

**Width back rest and seat
Length of chair in upright and tilted position**

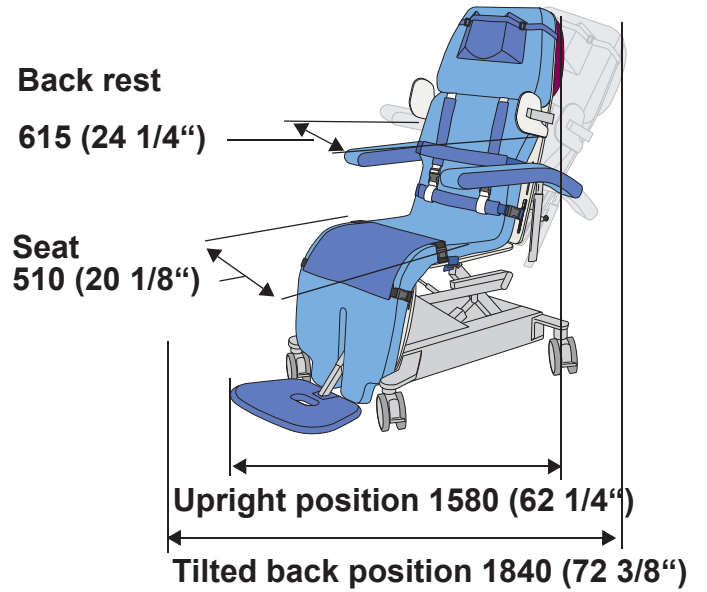

Chair side tilt

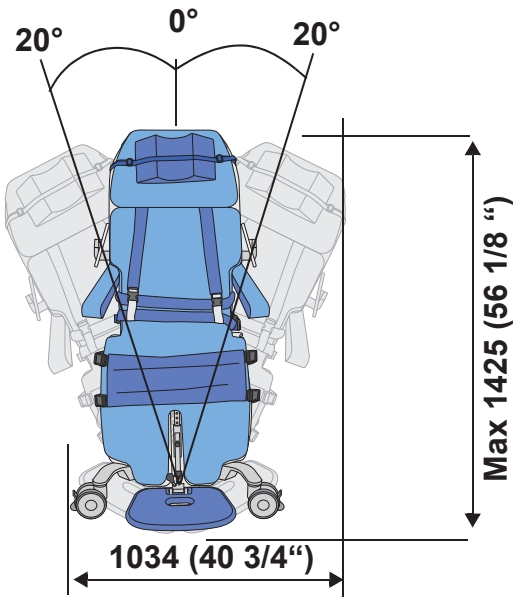

Turning radius stretcher

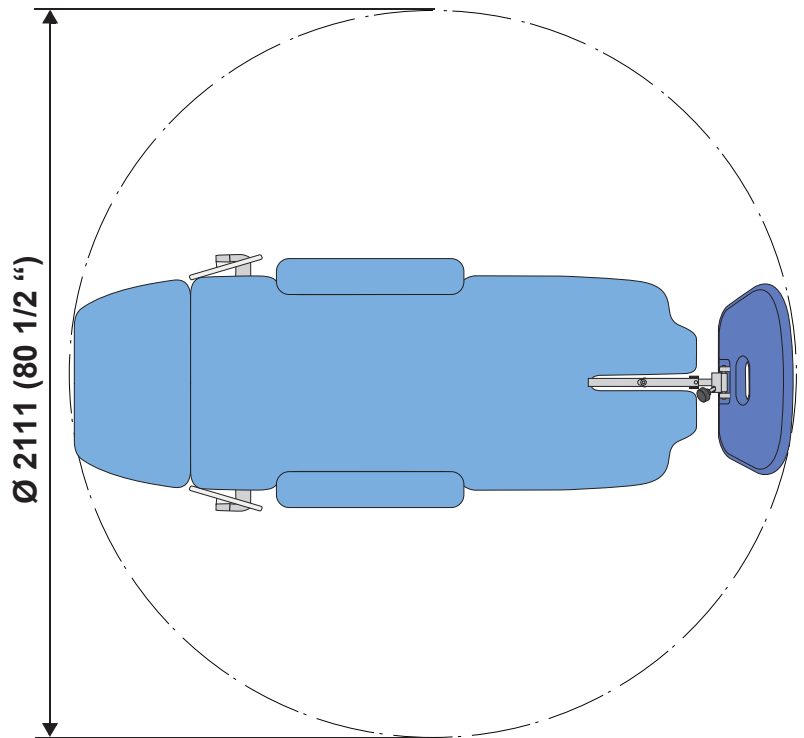

Turning radius chair

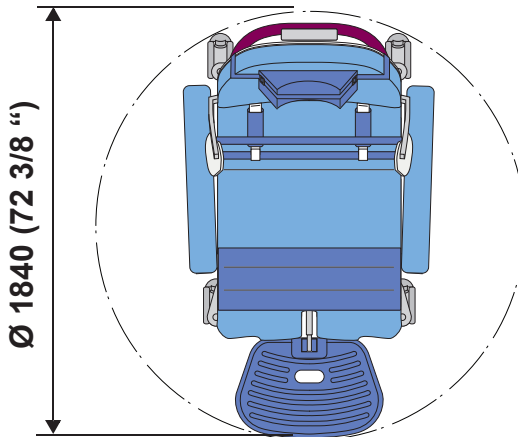

Labels

Label explanation

Battery Label	States safety and environmental information for the battery.
Data Label	States technical performance and requirements, e.g. the Input Power, Input Voltage and maximum Patient Weight etc.
Serial Number Label	States the product identification, serial number and year and month of manufacturing.
Identification Label	Identification labels on the different parts of the Sara Combilizer

Symbol explanation

	Total mass of equipment including its safe working load.
Safe Working Load	Defines the maximum total load of resident or any other load that may be on the <i>Sara Combilizer</i> .
IPX4	Degree of protection against splashing water.
24 VDC	Supply voltage.
2,5 Ah	Capacity.
	Type B, Applied part: protection against electrical shock in accordance with IEC 60601-1.
	Mandatory to read the Instructions for Use.
	Separate electrical and electronic components for recycling in accordance with the European Directive 2012/19/EU (WEE).
	Duty cycle 2 minutes ON, 18 minutes OFF.
	CE marking indicating conformity with European Community harmonised legislation.
	Model number.
	Serial number.

	The name and address of the manufacturer
	Certified according to NRTL through TÜV SÜD. See section, <i>Approvals and Lists of Standards</i>
	Environmental danger. Not for disposal.
	Rechargeable battery.
	Expiry date.
	Washing normal process max 70°C /158°F.
	Do not bleach.
	Tumble drying possible normal temperature.
	Do not iron.
	Washing normal process max 60°C/140°F.
	Recyclable
	Read instructions for use.
	Emergency stop button identification.
	Indicates the product is a Medical Device according to EU Medical Device Regulation 2017/745

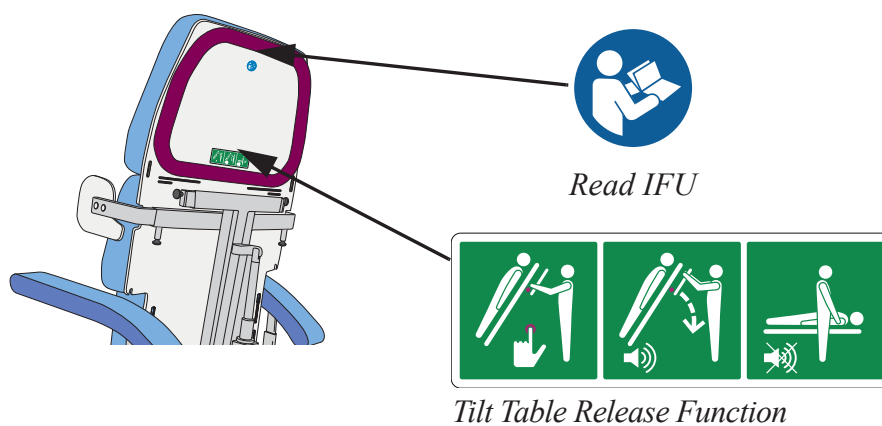
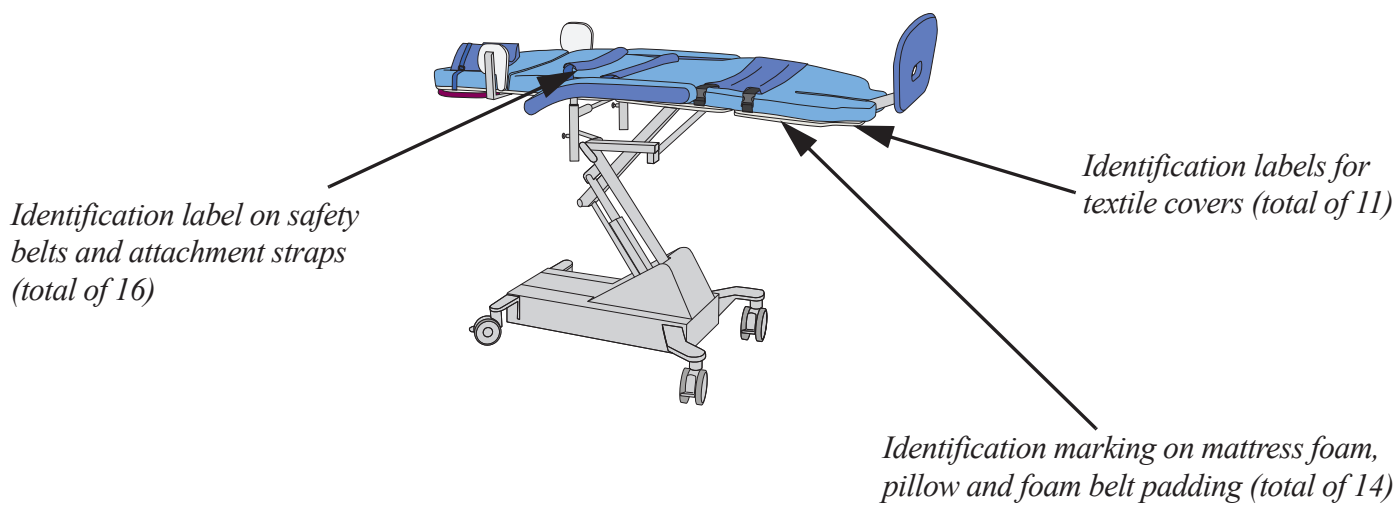
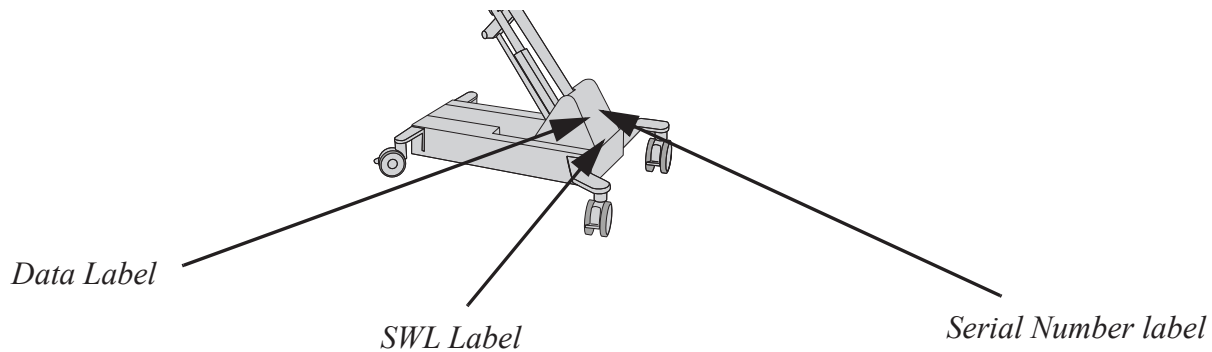

Fold down shoulder support

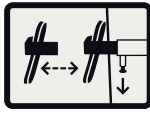
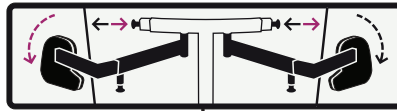

Adjust shoulder support

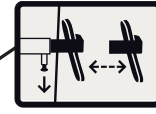

Adjust shoulder support

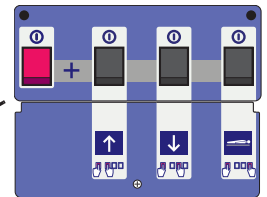
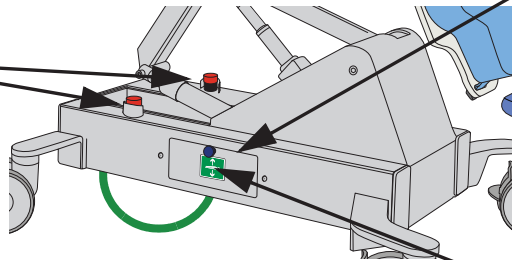
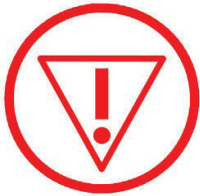
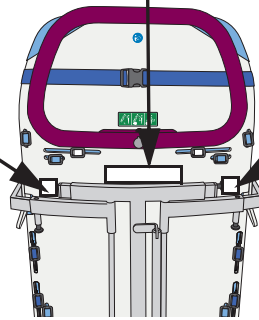

Emergency function buttons inside the box

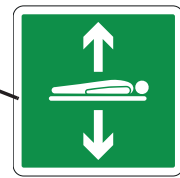

Emergency function box

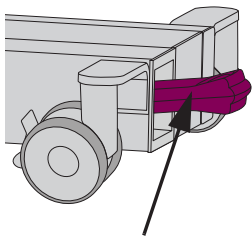

Battery label

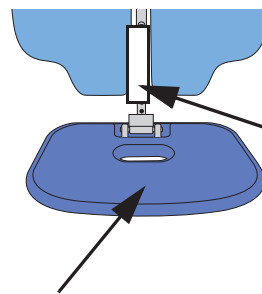

Foot support

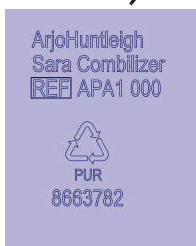

Foot support Identification

List of Standards and Certificates

STANDARD/ CERTIFICATE	DESCRIPTION
EN/IEC 60601-1:2005 AMD1:2012	Medical Electrical Equipment - Part 1: General Requirements for Basic Safety and Essential Performance.
ANSI/AAMI ES60601-1 (2005) AMD 1 (2012)	Medical Electrical Equipment - Part 1: General Requirements for Basic Safety and Essential Performance.
CAN/CSA-C22.2 No. 60601-1:14	Medical Electrical Equipment - Part 1: General Requirements for Basic Safety and Essential Performance.
ISO 10535:2006	Hoists for the transfer of disabled persons -- Requirements and test methods

Electromagnetic Compatibility (EMC)

Product has been tested for compliance with current regulatory standards regarding its capacity to block EMI (electromagnetic interference) from external sources.

Some procedures can help reduce electromagnetic interferences:

- Use only Arjo cables and spare parts to avoid increased emissions or decreased immunity which can compromise the correct functioning of the equipment.
- Ensure that other devices in patient-monitoring and/or life-support areas comply to accepted emissions standards.

WARNING

Wireless communications equipment such as wireless computer network devices, mobile phones, cordless telephones and their base stations, walkie-talkies, etc. can affect this equipment and should be kept at least 1.5 m away from the equipment.

Intended Environment: Professional Healthcare Facility Environment

Exceptions: HF Surgical Equipment and the RF Shielded room of an ME SYSTEM for magnetic resonance imaging

WARNING

Use of this equipment adjacent to or stacked with other equipment should be avoided because it could result in improper operation. If such use is necessary, this equipment and the other equipment should be observed to verify that they are operating normally.

Guidance and manufacturer's declaration – electromagnetic emission

Emission test	Compliance	Guidance
RF emissions CISPR 11	Group 1	This equipment uses RF energy only for its internal functions. Therefore its RF emissions are very low and are not likely to cause any interference in nearby electronic equipment.
RF emissions CISPR 11	Class B	This equipment is suitable for use in all establishments, including domestic establishments and those directly connected to the public low voltage power supply network that supplies buildings used for domestic purposes.

Guidance and manufacturer's declaration – electromagnetic immunity			
Immunity test	IEC 60601-1-2 test level	Compliance level	Electromagnetic environment – guidance
Electrostatic discharge (ESD) EN 61000-4-2	±2kV, ±4kV, ±8kV, ±15kV air ±8kV contact	±2kV, ±4kV, ±8kV, ±15kV air ±8kV contact	Floors should be wood, concrete or ceramic tile. If floors are covered with synthetic material, the relative humidity should be at least 30%.
Conducted disturbances induced by RF fields EN 61000-4-6	3V in 0,15 MHz to 80 MHz 6V in ISM and amateur radio bands between 0,15 MHz and 80 MHz 80% AM at 1 kHz	3V in 0,15 MHz to 80 MHz 6V in ISM and amateur radio bands between 0,15 MHz and 80 MHz 80% AM at 1 kHz	Portable and mobile RF communications equipment should be used no closer to any part of the product, including cables, than 1.0 m, if the transmitter's output power rating exceeds 1W ^a . Field strengths from fixed RF transmitters, as determined by an electromagnetic site survey, should be less than the compliance level in each frequency range ^b . Interference may occur in the vicinity of equipment marked with this symbol: 
Radiated RF electromagnetic field EN 61000-4-3	Professional Healthcare environment 3 V/m 80 MHz to 2,7 GHz 80% AM at 1 kHz	Professional Healthcare environment 3 V/m 80 MHz to 2,7 GHz 80% AM at 1 kHz	
Proximity fields from RF wireless communications equipment EN 61000-4-3	385 MHz - 27 V/m 450 MHz - 28 V/m 710, 745, 780 MHz - 9V/m 810, 870, 930 MHz - 28 V/m 1720, 1845, 1970, 2450 MHz - 28 V/m 5240,5500, 5785 MHz - 9V/m	385 MHz - 27 V/m 450 MHz - 28 V/m 710, 745, 780 MHz - 9V/m 810, 870, 930 MHz - 28 V/m 1720, 1845, 1970, 2450 MHz - 28 V/m 5240,5500, 5785 MHz - 9V/m	
Electrical fast transient/burst EN 61000-4-4	±1kV SIP/SOP ports 100 kHz repetition frequency	±1kV SIP/SOP ports 100 kHz repetition frequency	
Power frequency Magnetic field EN 61000-4-8	30 A/m 50 Hz or 60 Hz	30 A/m 50 Hz	Power frequency magnetic fields should be at levels characteristic of a typical location in a typical commercial or hospital environment.

^a Field strengths from fixed transmitters, such as base stations for radio (cellular/cordless) telephones and land mobile radios, amateur radio, AM and FM radio broadcast and TV broadcast cannot be predicted theoretically with accuracy. To assess the electromagnetic environment due to fixed RF transmitters, an electromagnetic site survey should be considered. If the measured field strength in the location in which the product is used exceeds the applicable RF compliance level above, the product should be observed to verify normal operation. If abnormal performance is observed, additional measures may be necessary.

^b Over the frequency range 150 kHz to 80 MHz, field strengths should be less than 1 V/m.

Parts and Accessories

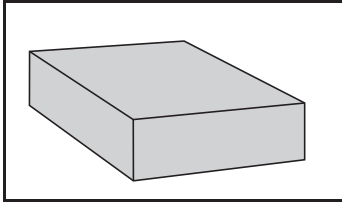

Rectangular
foot support blocks (2)
8663850-09

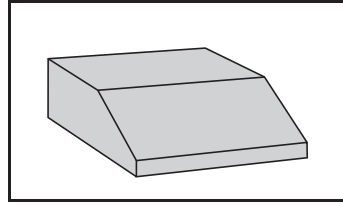

Wedge shaped
foot supports blocks (2)
8663849-09

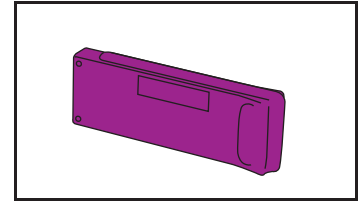

Battery
NEA0100-083

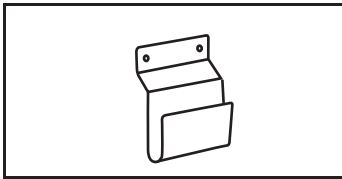

Battery Holder
8350891-031

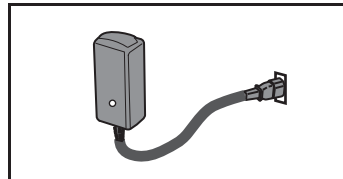

Battery Charger
NEA8000

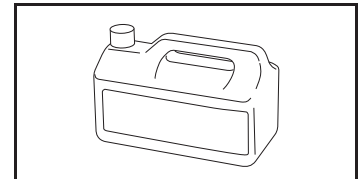

Disinfectant
To order contact local
representative.

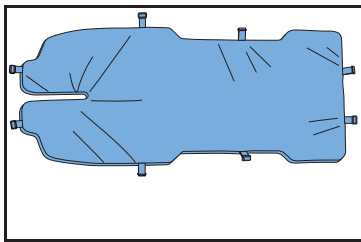

Body Mattress
Complete – AH1004031
Only cover – AH1004035

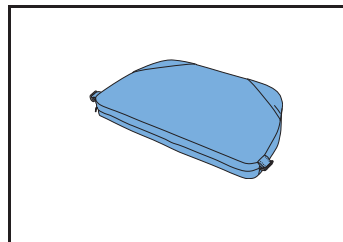

Head Mattress
Complete – 8663942-014
Only cover – 8663943-014

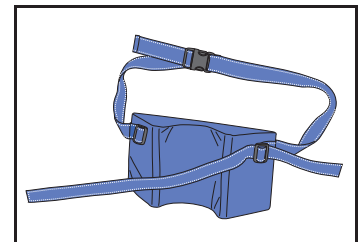

Pillow
Complete – 8663947-013

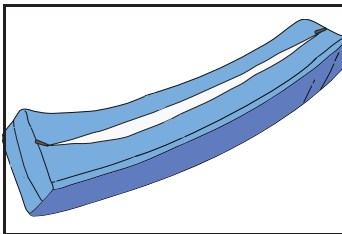

*Armrest Cushion
Complete – AH1005467
Only cover – AH1004109

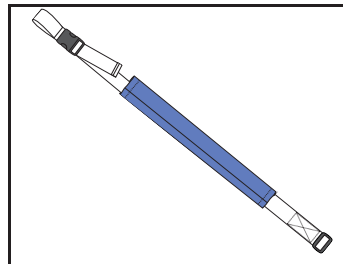

Shoulder Belt, two pieces
8547118-013

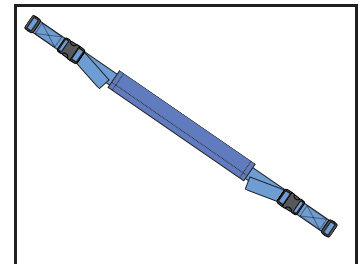

Chest and Hip Belt, two pieces
8547119-013

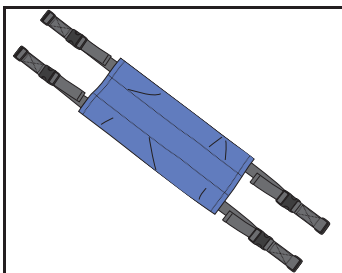

Knee Belt
8547120-013

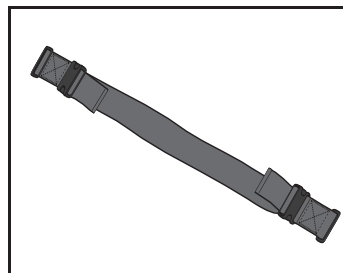

*Knee Belt Strap
AH1033148

*Order two, to replace the complete pair.

AUSTRALIA

Arjo Australia Pty Ltd
78, Forsyth Street
O'Connor
AU-6163 Western Australia
Tel: +61 89337 4111
Free: +1 800 072 040
Fax: + 61 89337 9077

BELGIQUE / BELGIË

Arjo NV/SA
Evenbroekveld 16
BE-9420 ERPE-MERE
Tél/Tel: +32 (0) 53 60 73 80
Fax: +32 (0) 53 60 73 81
E-mail: info.belgium@arjo.com

BRASIL

Arjo Brasil Equipamentos Médicos Ltda
Rua Marina Ciufuli Zanfelice, 329 PB02 Galpão
- Lapa
São Paulo – SP – Brasil
CEP: 05040-000
Phone: 55-11-3588-5088
E-mail: vendas.latam@arjo.com
E-mail: servicios.latam@arjo.com

CANADA

Arjo Canada Inc.
90 Matheson Boulevard West
Suite 300
CA-MISSISSAUGA, ON, L5R 3R3
Tel/Tél: +1 905 238 7880
Free: +1 800 665 4831 Institutional
Free: +1 800 868 0441 Home Care
Fax: +1 905 238 7881
E-mail: info.canada@arjo.com

ČESKÁ REPUBLIKA

Arjo Czech Republic s.r.o.
Na Strži 1702/65
140 00 Praha
Czech Republic
Phone No: +420225092307
e-mail: info.cz@arjo.com

DANMARK

Arjo A/S
Vassingerødvej 52
DK-3540 LYNGE
Tel: +45 49 13 84 86
Fax: +45 49 13 84 87
E-mail:
dk_kundeservice@arjo.com

DEUTSCHLAND

Arjo GmbH
Peter-Sander-Strasse 10
DE-55252 MAINZ-KASTEL
Tel: +49 (0) 6134 186 0
Fax: +49 (0) 6134 186 160
E-mail: info-de@arjo.com

ESPAÑA

Arjo Ibérica S.L.
Parque Empresarial Rivas Futura, C/Marie
Curie 5
Edificio Alfa Planta 6 oficina 6.1-.62
ES-28521 Rivas Vacia, MADRID
Tel: +34 93 583 11 20
Fax: +34 93 583 11 22
E-mail: info.es@arjo.com

FRANCE

Arjo SAS
2 Avenue Alcide de Gasperi
CS 70133
FR-59436 RONCQ CEDEX
Tél: +33 (0) 3 20 28 13 13
Fax: +33 (0) 3 20 28 13 14
E-mail: info.france@arjo.com

HONG KONG

Arjo Hong Kong Limited
Room 411-414, 4/F, Manhattan Centre,
8 Kwai Cheong Road, Kwai Chung, N.T.,
HONG KONG
Tel: +852 2960 7600
Fax: +852 2960 1711

ITALIA

Arjo Italia S.p.A.
Via Giacomo Peroni 400-402
IT-00131 ROMA
Tel: +39 (0) 6 87426211
Fax: +39 (0) 6 87426222
E-mail: Italy.promo@arjo.com

MIDDLE EAST

Arjo Middle East FZ-LLC
Office 908, 9th Floor,
HQ Building, North Tower,
Dubai Science Park,
Al Barsha South
P.O Box 11488, Dubai,
United Arab Emirates
Direct +971 487 48053
Fax +971 487 48072
Email: Info.ME@arjo.com

NEDERLAND

Arjo BV
Biezenwei 21
4004 MB TIEL
Postbus 6116
4000 HC TIEL
Tel: +31 (0) 344 64 08 00
Fax: +31 (0) 344 64 08 85
E-mail: info.nl@arjo.com

NEW ZEALAND

Arjo Ltd
34 Vestey Drive
Mount Wellington
NZ-AUCKLAND 1060
Tel: +64 (0) 9 573 5344
Free Call: 0800 000 151
Fax: +64 (0) 9 573 5384
E-mail: nz.info@Arjo.com

NORGE

Arjo Norway AS
Olaf Helsets vei 5
N-0694 OSLO
Tel: +47 22 08 00 50
Faks: +47 22 08 00 51
E-mail: no.kundeservice@arjo.com

ÖSTERREICH

Arjo GmbH
Lemböckgasse 49 / Stiege A / 4.OG
A-1230 Wien
Tel: +43 1 8 66 56
Fax: +43 1 866 56 7000

POLSKA

Arjo Polska Sp. z o.o.
ul. Ks Piotra Wawrzyniaka 2
PL-62-052 KOMORNIKI (Poznań)
Tel: +48 61 662 15 50
Fax: +48 61 662 15 90
E-mail: arjo@arjo.com

PORTUGAL

Arjo em Portugal
MAQUET Portugal, Lda.
(Distribuidor Exclusivo)
Rua Poeta Bocage n.º 2 - 2G
PT-1600-233 Lisboa
Tel: +351 214 189 815
Fax: +351 214 177 413
E-mail: Portugal@arjo.com

SUISSE / SCHWEIZ

Arjo AG
Fabrikstrasse 8
Postfach
CH-4614 HÄGENDORF
Tél/Tel: +41 (0) 61 337 97 77
Fax: +41 (0) 61 311 97 42

SUOMI

Arjo Scandinavia AB
Riihitontuntie 7 C
02200 Espoo
Finland
Puh: +358 9 6824 1260
E-mail: Asiakaspalvelu.finland@arjo.com

SVERIGE

Arjo International HQ
Hans Michelsensgatan 10
SE-211 20 MALMÖ
Tel: +46 (0) 10 494 7760
Fax: +46 (0) 10 494 7761
E-mail: kundservice@arjo.com

UNITED KINGDOM

Arjo UK and Ireland
Houghton Hall Park
Houghton Regis
UK-DUNSTABLE LU5 5XF
Tel: +44 (0) 1582 745 700
Fax: +44 (0) 1582 745 745
E-mail: sales.admin@arjo.com

USA

Arjo Inc.
2349 W Lake Street Suite 250
US-Addison, IL 60101
Tel: +1 630 307 2756
Free: +1 800 323 1245 Institutional
Free: +1 800 868 0441 Home Care
Fax: +1 630 307 6195
E-mail: us.info@arjo.com

JAPAN

Arjo Japan K.K.
東京都港区虎ノ門三丁目7番8号 ランディッ
ク第2虎ノ門ビル9階
電話 : +81 (0)3-6435-6401

Address page - REV 24: 04/2019

At Arjo, we are committed to improving the everyday lives of people affected by reduced mobility and age-related health challenges. With products and solutions that ensure ergonomic patient handling, personal hygiene, disinfection, diagnostics, and the effective prevention of pressure ulcers and venous thromboembolism, we help professionals across care environments to continually raise the standard of safe and dignified care. Everything we do, we do with people in mind.



ArjoHuntleigh AB
Hans Michelsensgatan 10
211 20 Malmö, Sweden
www.arjo.com

arjo

